

SK-O (L) 330- Pro Orbital and Linear Digital Shaker

SK-O (L) 180- Pro Orbital and Linear Digital Shaker



User Manual

SK-L330-Pro
SK-O330-Pro
SK-L180-Pro
SK-O180-Pro

Linear Digital shaker(7.5Kg)
Orbital Digital shaker(7.5Kg)
Linear Digital shaker(2.5Kg)
Orbital Digital shaker(2.5Kg)

*Please read the User Manual and the related Video of this instrument on our website carefully before use, and follow all operating and safety instructions!
The website www.scilogex.com*

SCIOGEX

Contents

Contents	Inside front cover
Preface	1
Service	1
Warranty	1
1.Safety Instructions	2
2.Proper Use	3
3.Inspection	3
3.1 Receiving Inspection	3
3.2 Listing of Items	3
4. Trial Run	3
5.Control and Set	4
5.1 Control	4
5.2 Set	5
5.2.1 Set Time	5
5.2.2 Setting Speed	5
6.Operating Modes	6
6.1 Mode A	6
6.2 Mode B	7
6.3 Switching the Mode	7
6.4 Switch the shaking direction	8
7.Supported Load	8
8.Faults	8

9.Interface	8
10.Maintenance and Cleaning	9
11.Associated Standards and Regulations	9
12.Technical Data	10
13.Products and Accessories	10

Preface

Welcome to the “Orbital and Linear Digital Shaker User Manual” . Users should read this manual carefully, follow the instructions and procedures, and beware of all the cautions when using this instrument.

Service

When help needed, you can always contact manufacturer for technical support in the following ways:

SCIOGEX, LLC

500 Four Rod Road

Suite 122

Berlin, CT 06037

USA

Tel: 1- (860) 828-5614

Fax: 1- (860) 828-5389

E-mail: info@scilogex.com

Website: [Http://www.scilogex.com](http://www.scilogex.com)

Please provide the customer care representative with the following information:

- Serial Number (on the rear panel)
- Description of problem (i.e., hardware or software)



- Methods and procedures adopted to resolve the problems
- Your contact information

Warranty

You have purchased a Scilogex instrument. This instrument is warranted to be free from defects in materials and workmanship under normal use and service, for a period of 24 months from the date of invoice. The warranty is extended only to the original purchaser. It shall not apply to any product or parts which have been damaged on account of improper installation, improper connections, misuse, accident or abnormal conditions of operation.

For claims under the warranty please contact your local dealer. You may also send the instrument direct to our works, enclosing the invoice copy and by giving reasons for the claim. You would be solely liable for freight costs.

1. Safety Instructions

	<p>Warning!</p> <ul style="list-style-type: none"> • Read the operating instructions completely before use and follow the safety instructions. • Ensure that only trained staff work with the instrument.
	<p>Protective ground contact!</p> <ul style="list-style-type: none"> • Make sure the socket must be earthed (protective ground contact) before use.

- Wear the personal protective equipment in accordance with the hazard category of the media to be processed.
 - Splashing of liquids.
 - vibration force led to broken glass container.
 - The body, hair, clothes, jewelry are inhaled.
- Use the instrument following the safety instructions and profession safety rules to avoid any accident.
- Users are not allowed to touch moving parts of the instrument to avoid any accidents. Pay attention to protect hands or fingers from rolling when moving the instrument.
- Set up the instrument in a spacious area on an stable, clean, non-slip, dry and fireproof surface. Do not operate the instrument in explosive atmospheres, with hazardous substances or under water.
- Observe the vessel on the shaking table for medium

splashing out of liquid when setting the motor speed. Reduce the motor speed if the instrument is not running smoothly.

- Accessories must be securely attached to the instrument so that it cannot come off by itself, and vessels must be firmly placed on the shaking table to avoid any injury.
- Working with combustible media or flammable materials may result in additional hazards. Only process media that will not react dangerously to the extra energy produced through processing should be used on the instrument.
- Safe operation is only guaranteed with the accessories described in the “Accessories” chapter and by following the operating instructions in full. Always disconnect the plug before fitting accessories. Check the instrument and accessories beforehand for damage each time you use them. Do not use damaged components.
- The instrument may only be opened by trained technicians. And always disconnect the plug beforehand.
- The operating voltage required as stated on the instrument and voltage in the supply network must match.
- Do not cover the instrument. Protect the instrument and accessories from bumps and impacts.
- Keep away from high magnetic field.

2. Proper use

The instrument is designed for mixing or shaking liquids in schools, laboratories or factories. SK-330/180-Pro is suitable for usage in various attachments for mixing liquids in bottles, flasks, test tubes for a maximum supported weight of 7.5 kg(330)and 2.5Kg(180). This instrument is not suitable for use in residential areas or other areas that may cause danger to the user or instrument as mentioned in chapter 1.

3. Inspection

3.1 Receiving Inspection

Unpack the instrument carefully and check for any damages which may have arisen during transport. If it happens, please contact manufacturer for technical support.

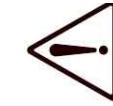

Note:

If there is any apparent damage to the system, please do not plug it into the power line.

3.2 Listing of Items

The packing includes the following items:

Items	Qty
Main unit	1
Power cable	1
User manual	1

Table 1

4. Trial run

Do trial operation as follows:

- Make sure the required operating voltage and power supply voltage match.
- Ensure the socket is securely earthed.
- Plug in the power cable, Power ON the instrument.
- LCD displays the safe rotary speed limit.
- LCD displays operating mode.
- Turn the speed knob to set the rated rotary speed
- Press the speed knob. And the shaking function is switched ON.
- Press the motor regulation knob again. and the shaking function is switched OFF.

If these operations above are normal, the instrument is ready to operate following the “operation” chapter. If these operations are not normal, the instrument may be in security protection state or be damaged.

If the mounting surface is not even, you can improve the stability of the instrument with the adjustable feet. To do this, turn the appropriate foot downward with the wrench until the instrument is standing securely on the surface.

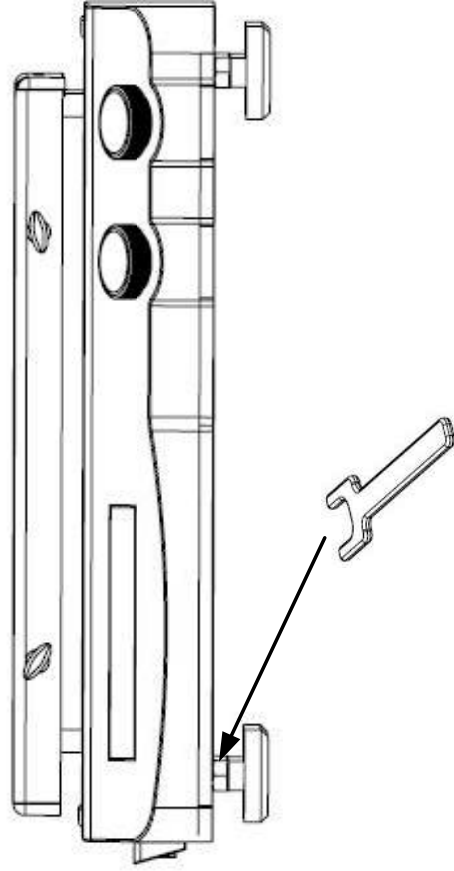

Figure 1

5. Control and Set

5.1 Control

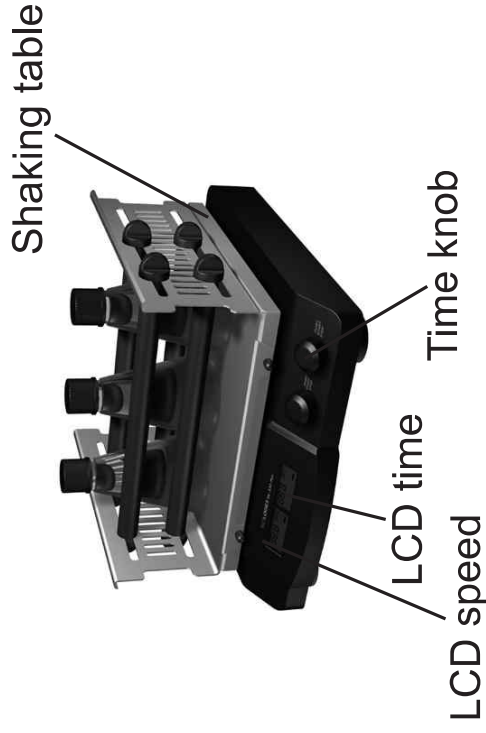

Figure 2

Items	Descriptions
Speed knob	Set the rated rotary speed. “rotation” is switched ON or OFF via pressing the knob.
Time knob	Set working time . “rotation” is switched ON or OFF via pressing the knob
LCD	Display the status of instrument and any set
Mains switch	Switch ON or OFF.

Table 2

- Put the instrument on stable and safe place and plug in the mains power.
- Turn ON the mains switch on the left panel.
- The instrument starts self-test.
- The instrument shows rated speed and time after initialization.
- Turn the speed knob on the left side to set the rated speed.
- Press the speed knob and characters on the left LCD do not flash any more, and the shaking function is switched ON.
- Press the speed knob again and characters on the left LCD begin to flash, and the shaking function is switched OFF.
- Turn the time knob on the left side to set the rated time
- Press the time knob and characters on the LCD do not flash any more, and the timing function is switched ON.
- Press the time knob again and characters on the right LCD begin to flash, and the timing function is switched OFF.

5.2 Set

5.2.1 Set time

The rated shaking time can be set by turning the time knob on the right. A distinction is made for the shaking time setting between timed mode and continuous operation. If continuous mode is selected, the shake can continue its shaking function for any amount of time with the previously set speed. If timed mode is selected, the shaker can run in the

set time. After the instrument is powered OFF and restarted, the set time is erased to zero blanking and it switches into offline operating mode.

If a target time (max. 19h 59min) and speed are set, users can activate the instrument with pressing the time knob, and the time begin to read.If:

- A, pressing the time knob, the speed and the time will stop. Pressing the time knob again, restart the shake function, the time will use the pre-set time
- B, pressing the speed knob, the speed and the time will stop; Pressing the time knob again, restart the shake function, the time not (There are flashing on the right of the LCD), pressing the time knob again restart the time function. The time will use the pre-set time.



Note:

The current set time can be varied at any time.

5.2.2 Setting Speed

The rated speed and upper speed limit can be set by turning the speed knob (As the Figure 6). The continuous mode can be switched ON with pressing the left knob without the time setting and switched OFF with pressing the knob again... Adjust the motor speed knob slowly in order to keep the instrument running smoothly.



Note:

The current set speed can be varied at any time.

6. Operating modes

6.1 Mode A

Operating mode A is the default mode set in factory. After turning ON the instrument with the mains switch, the shaking and timing functions are turned OFF. The LCD displays the set time and speed values. They are adopted or varied when the corresponding functions are turned ON. After turning ON the instrument, the following process will be shown on the display.

- The left LCD displays “SAF” and the right displays the upper speed limit(rpm) which can be set by pressing the speed knob and turning at the same time.



Figure 3

- The LCD displays run modes “StA” , “A” or “B” for about 2 seconds.



Figure 4

- The set or stored speed value is shown in the left display, and the set or stored time value is shown in the right display. Turn the speed knob and time knob can set the speed and time.

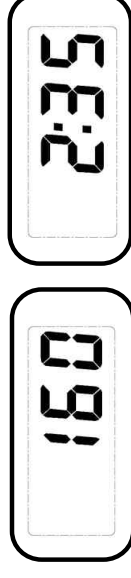

Figure 5

- After pressing the speed knob or time knob, the instrument begins to run at the set speed. The actual speed and time remaining are shown in the LCD. If the remaining has reached zero, the shaker stops its motion. Pressing the speed knob alone, the instrument will work at continuous mode(The time function is OFF)



Figure 6

Note:



The set values can be varied during shaking. Shaking can be stopped by pressing the left or right knob.

6.2 Mode B

When the instrument is turned ON and values for speed and time are erased to zero, users can set. The upper speed limit that has been set is taken over from operating mode A and cannot be modified. After the power has been turned OFF, the instrument will no longer automatically start up in operating Mode B by itself.

After turning ON the instrument and selected run mode, the following process will be shown on the display.

- The left LCD displays “SAF” and the right displays the upper speed limit(rpm) which cannot be changed.

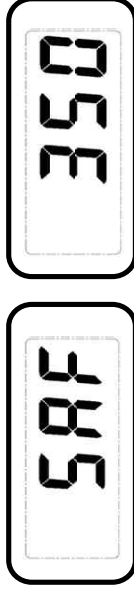

Figure 7

- The LCD displays run modes “StA” for about 2 seconds.



Figure 8

- The set speed value is shown in the left display, and the set time value is shown in the right display. Then set the motor rotary speed and time.

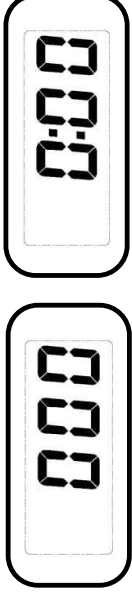

Figure 9

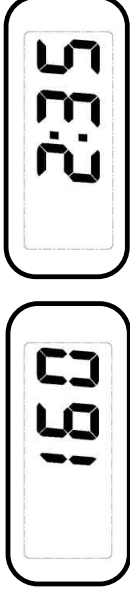

Figure 10

- After pressing the speed knob or time knob, the instrument begins to run at the set speed. The actual speed and time remaining are shown in the LCD. If the remaining has reached zero, the shaker stops its motion.

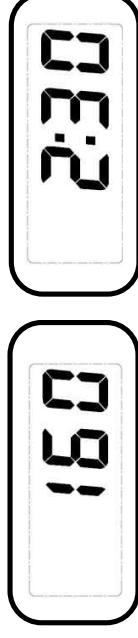

Figure 11

Note:



The set values can be varied during shaking.
Shaking can be stopped by pressing the left or right knob.

6.3 Switching the mode

Switch the operating mode as follows:

- Turn OFF the instrument with the mains switch.
- Hold down both knobs and turn ON the instrument with

the mains switch. After about 5 second, you can let go of the knobs.

- Switch between operating Modes A and B in order.

6.4 Switch the shaking direction

Change the shaking direction according to the steps as follows:

- Turn OFF the instrument;
- Press and hold time knob, at the same time turn on the instrument, release the time knob after 10 seconds;
- Switch the operation direction in turn.

7. Supported load

In order to ensure safe, the shaker must only be operated within the supported weight (7.5kg for 330 and 2.5Kg for 180).

Make sure the holding surface of the shaker is always clean and level. Ensure the individual shaking vessels must be placed evenly and fastened securely in the middle of the shaking table no matter one or multiple shaking vessels are placed.

8. Faults

- When switched ON, the instrument doesn't work

- Check whether the power cable fitted well

- Check whether the fuse is broken

- The speed cannot reach set value

- Check whether it is overloaded

- The motor does not start via pressing the speed knob and time knob

- Check whether the time is set to zero

9. Interface

SK-O330(180)-Pro/ SK-L330(180)-Pro Orbital and Linear Digital Shaker, special adapter and cable are used to link to external device.and the Standard 9-pin interface to connect with the PC.

- The cable between the shaker and the computer used EIA Standard RS232C communication line, corresponding to the DIN 66020 interface.
- Transmission method: Asynchronous signal transmission.
- Mode of transmission: Fully Duplex.
- 1 start bit; 8 character bits; 1 stop bit.
- Transmission speed: 9600 bit/s

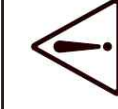

Note:

Forbid to plug in and plug off the power cable when the instrument working

10. Maintenance and cleaning

Use and maintain the instrument in right way to keep it in good operating state in order to lengthen its life time and avoid the damage to the instrument. Only use the cleaning agents which have been approved by manufacturer to clean the instrument.

Only use cleanser that we advised as below

Dyes	Isopropyl alcohol
Construction materials	Water containing tenside / isopropyl alcohol
Cosmetics	Water containing tenside / isopropyl alcohol
Foodstuffs	Water containing tenside
Fuels	Water containing tenside

For materials which are not listed, please request information from manufacturer or your supplier. Before using another than the recommended method for cleaning or decontamination, the user must ascertain that this method does not destroy the instrument. Wear the proper protective gloves during cleaning of the instrument.

Note:

- Electrical instrument may not be placed in the cleansing agent for the purpose of cleaning.
- The instrument must be cleaned and put it into the initial packaging carton before sending to service for repair, avoiding the contamination of hazardous.



- Switch OFF the instrument and put it in the dry, clean, stable place at room temperature in long-term disuse.

11. Associated standards and regulations

Construction in accordance with the following safety standards

EN 61010-1

UL 3101-1

CAN/CSA C22.2(1010-1)

EN 61010-2-10

Construction in accordance with the following EMC standards

EN 61326-1





12. Technical data

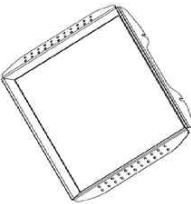
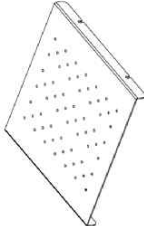

Items	Parameters	Timer display
Voltage [VAC]	100~240	LCD
Frequency [Hz]	50/60	1 – 1199
Power [W]	30	Items
Shaking movement	Orbital/ linear	Parameters
Orbital diameter [mm]	10 (SK-O(L)330-Pro) / 4.5 (SK-O(L)180-Pro)	Time / Continuous operation
Max. shaking weight (with attachment) [kg]	7.5 (SK-O(L)330-Pro) / 2.5 (SK-O(L)180-Pro)	420 × 370 × 100(SK-O(L)330-Pro)/ 340 × 300 × 100(SK-O(L)180-Pro)
Motor type	External rotor brushless motor	13.5 (SK-O(L)330-Pro)/ 8.1(SK-O(L)180-Pro)
Motor rating input [W]	28	5 – 40
Motor rating output [W]	15	Permissible ambient temperature [° C]
Permissible ON time [%]	100	Permissible relative humidity
Speed range [rpm]	100-350(SK-L330-Pro) 100-500(SK-O330-Pro) 100-350(SK-L180-Pro) 100-800(SK-O180-Pro)	80%
Speed display	LCD	Protection class acc. To DIN EN60529
Timer	Yes	IP21
		RS232 interface
		Yes

Table 3

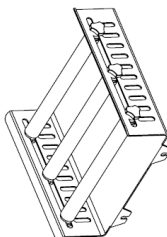
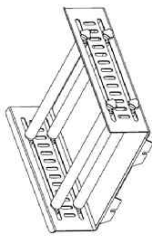
13. Products and Accessories

Cat.No	Descriptions	Cat.No	Descriptions
831010019999	SK-L180-Pro Linear Digital Shaker (2.5Kg),No Attachment, Cn plug, 110/220/50Hz/60Hz	832010049999	SK-O180-Pro Orbital Digital Shaker (2.5Kg), No Attachment, UK plug, 110V/220V/50Hz/60Hz
831010039999	SK-L180-Pro Linear Digital Shaker (2.5Kg),No Attachment, Euro plug, 110/220/50Hz/60Hz	832010059999	SK-O180-Pro Orbital Digital Shaker (2.5Kg), No Attachment, USA plug, 110V/220V/50Hz/60Hz
831010049999	SK-L180-Pro Linear Digital Shaker (2.5Kg),No Attachment, UK plug, 110/220/50Hz/60Hz	831010029999	SK-L330-Pro Linear Digital Shaker (7.5 Kg), No Attachment, Cn plug, 110V/220V/50Hz/60Hz
831010059999	SK-L180-Pro Linear Digital Shaker (2.5Kg),No Attachment, USA plug, 110/220/50Hz/60Hz	831010069999	SK-L330-Pro Linear Digital Shaker (7.5 Kg), No Attachment, Euro plug, 110V/220V/50Hz/60Hz
832010019999	SK-O180-Pro Orbital Digital Shaker (2.5Kg), No Attachment, Cn plug, 110V/220V/50Hz/60Hz	831010079999	SK-L330-Pro Linear Digital Shaker (7.5 Kg), No Attachment, UK plug, 110V/220V/50Hz/60Hz
832010039999	SK-O180-Pro Orbital Digital Shaker (2.5Kg), No Attachment, Euro plug, 110V/220V/50Hz/60Hz	831010089999	SK-L330-Pro Linear Digital Shaker (7.5 Kg), No Attachment, USA plug, 110V/220V/50Hz/60Hz
		832010029999	SK-O330-Pro Orbital Digital Shaker (7.5 Kg), No Attachment, Cn plug, 110V/220V/50Hz/60Hz

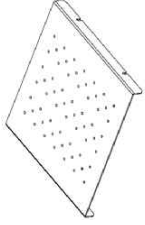
Cat. No	Descriptions		18900041 SK330.4	SK330.4 Dish Attachment (with slip-resistant foil)
832010069999	SK-O330-Pro Orbital Digital Shaker (7.5 Kg), No Attachment, Euro plug, 110V/220V/50Hz/60Hz		18900028 SK 330.2	SK 330.2 Fixing Clip Attachment
832010079999	SK-O330-Pro Orbital Digital Shaker (7.5 Kg), No Attachment, UK plug, 110V/220V/50Hz/60Hz		18900036	Bars for SK330.1 Universal Attachment, black
832010089999	SK-O330-Pro Orbital Digital Shaker (7.5 Kg), No Attachment, USA plug, 110V/220V/50Hz/60Hz		18900025 SK 180.1	SK 180.1 Universal Attachment
Accessories				
Accessories Figure	Cat.No and Designation	Operation mode		
	18900027 SK330.1	SK 330.1 Universal Attachment	18900038 SK180.3	SK180.3 Lengthways Roller Attachment
	18900040 SK330.3	SK330.3 Lengthways Roller Attachment	18900039 SK180.4	SK180.4 Dish Attachment (with slip-resistant foil)

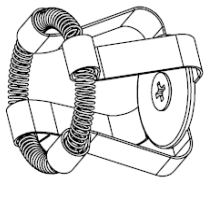
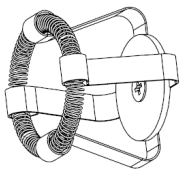
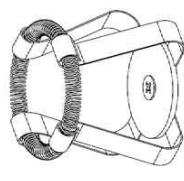
	18900026 SK 180.2	SK 180.2 Fixing Clip Attachment
	18900037	Bars for SK180.1 Universal Attachment, black
	18900029 SK330.2.1	Fixing Clips for Flask Volume 25 ml
	18900030 SK330.2.2	Fixing Clips for Flask Volume 50 ml
	18900031 SK330.2.3	Fixing Clips for Flask Volume 100 ml

	18900032 SK330.2.4	Fixing Clips for Flask Volume 200/250 ml
	18900033 SK330.2.5	Fixing Clips for Flask Volume 500 ml
	18100319 RS232 9-Pin interface line	Suitable to shakerPC Software used

Table 4

Note:

The software ShakerPC can be downloaded free on our website www.scilogex.com.

SCIOLOGEX, LLC
1275 Cromwell Ave.

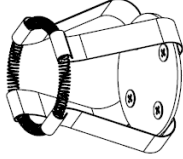
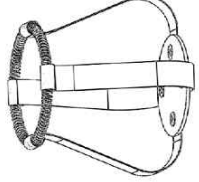
Suite C6

Rocky Hill, CT 06067 USA

Tel: +1(860) 436-9221

Fax: +1(860) 436-9745

info@scilogex.com | www.scilogex.com