



# LABORATORY EQUIPMENT CATALOG

shakers • hotplates/stirrers • dry block heaters • vortex mixers • homogenizers • overhead mixers • clamps • gas cylinder safety supports • flow control • boiling granules

Contents

4	.....	<b>Troemner History</b>
5	.....	<b>Contact Information/Ordering Information</b>
6	.....	<b>Warranty and Returns/Quality &amp; Certifications/Distributor Information</b>
7	.....	<b>Custom Manufacturing</b>
9	.....	<b>Education Products</b>
17	.....	<b>Shakers</b>
18	.....	<b>Open-Air Shakers</b>
40	.....	<b>Incubating Shakers</b>
42	.....	<b>Thermal Shake Touch</b>
58	.....	<b>Platforms &amp; Accessories</b>
62	.....	<b>Flask Clamps</b>
64	.....	<b>Test Tube Racks</b>
67	.....	<b>Hotplates/Stirrers</b>
68	.....	<b>Professional Hotplates/Stirrers/Hotplate-Stirrers</b>
74	.....	<b>Advanced Hotplates/Stirrers/Hotplate-Stirrers</b>
76	.....	<b>Round Top Hotplate-Stirrers</b>
79	.....	<b>Basic Mini Hotplates/Stirrers/Hotplate-Stirrers</b>
80	.....	<b>Specialty Stirrers</b>
86	.....	<b>Hotplate Stirrer Accessories</b>
87	.....	<b>Supports</b>
89	.....	<b>Dry Block Heaters</b>
95	.....	<b>Modular Blocks &amp; Accessories</b>
99	.....	<b>Vortex Mixers</b>
101	.....	<b>Heavy-Duty Vortex Mixers</b>
104	.....	<b>Microplate Vortex Mixers</b>
107	.....	<b>Vortex Mixers</b>
113	.....	<b>Multi-Tube Vortexers</b>
117	.....	<b>Homogenizers</b>
123	.....	<b>Overhead Mixers</b>
132	.....	<b>Accessories</b>
139	.....	<b>Clamps</b>
142	.....	<b>Multi-Purpose</b>
148	.....	<b>Specialty</b>
152	.....	<b>Connectors &amp; Holders</b>
155	.....	<b>Lab-Frames</b>
159	.....	<b>Support Stands</b>
162	.....	<b>Lab-Lifts</b>
164	.....	<b>Gas Cylinder Safety Supports</b>
167	.....	<b>Flow Control</b>
169	.....	<b>Hengar Boiling Granules &amp; Microplate Stability Chamber</b>
173	.....	<b>Other Quality Talboys Products</b>



## Troemner History

Since 1838, Henry Troemner, LLC has enjoyed a long history as the leader in the field of precision measurements.



The company started as a manufacturer of scales, balances and weights in Philadelphia, Pennsylvania. Henry Troemner, a German immigrant, was originally a locksmith and learned the balance craft after he arrived in Philadelphia. From the beginning, Troemner earned a reputation as being a manufacturer of high quality products. The business grew steadily after the discovery of gold in California during the 1840's as the company was known for its bullion and assay balances. Henry Troemner's three sons continued to develop and grow the business, and by the early 1900's Troemner was recognized internationally as a world leader in the balance and scale manufacturing

industry. During the 1950's Troemner's balance and scale product line was updated to meet market demand and the production of precision weights became a larger part of its overall business. In 1958, Troemner published the company's first comprehensive catalog of standard weights and began to offer a weight calibration service for customers' weights. This important service is one that continues to this day. Over the years Troemner has enhanced its reputation as being the premier company in the metrology industry by achieving ISO 9001 certification, and accreditation in our laboratories by both the National Institute of Standards and Technology (NIST) administered National Voluntary Laboratory Accreditation Program (NVLAP Lab Code 105013-0), and the United Kingdom Accreditation Service (A UKAS Accredited Calibration Laboratory No. 0516).



### Troemner Today

Over the years Troemner has continued to expand and increase its expertise in manufacturing and measurement capabilities. Troemner relocated to Thorofare, New Jersey in 1999 to a state-of-the-art specially designed corporate headquarters, which was planned by a team of employees, engineers, and architects to specifically meet the customer's needs for high precision calibrations. Troemner's laboratories provide customers with all the data and traceability information they need for their calibration items. The Calibration Laboratories' physical conditions and state-of-the-art equipment enable Troemner to produce measurements with very small uncertainties for its customers. Troemner is not only committed to quality calibrations, but to the product itself as evidenced by the introduction of a unique material used to manufacture weights called Troemner Alloy 8, a specially blended stainless steel with very low magnetic properties. Troemner is committed to achieving the highest levels of accreditation for all of our calibration services which include mass, mass magnetic susceptibility, mass density determinations, pipettes, temperature, pressure, humidity, thermal mass flow, electrical, dimensional, and time and frequency. We continue to research and add new calibration services to meet the diverse needs of our customers.

### Manufacturer of Laboratory Equipment

At Troemner we have continued to expand and increase our expertise in manufacturing and measurement capabilities. In addition to our weights and calibration business, Troemner broadened its expertise into the development and manufacture of a full line of laboratory equipment. For over 50 years, Troemner has been a leading provider of reliable, high quality laboratory equipment products. As the needs of our customers have changed we have added to our product line. In 2000 Troemner acquired the Talboys overhead mixer product line and we have expanded the laboratory equipment offering to meet the unique needs of our customers.

Today Troemner's Talboys laboratory equipment products include shakers, incubating shakers, vortex mixers, hotplate-stirrers, dry block heaters, overhead mixers, homogenizers, microplate stability chambers, Hengar boiling granules, and clamps. Our Talboys laboratory equipment products are manufactured under an ISO 9001 accredited quality system. Many of these products are UL, CUL, CSA, CE, and TUV certified. Troemner strives to provide our customers with exactly what they need to run their laboratories efficiently and safely.

For more information on Troemner's Weight and Calibration Services visit our website at [www.troemner.com](http://www.troemner.com).



## Contact Information

### Contact Information

#### Troemner, LLC

201 Wolf Drive

Thorofare, NJ 08086

Website: [www.troemner.com](http://www.troemner.com) E-mail: [info@talboys.com](mailto:info@talboys.com)

Phone: (856) 686-1600 Toll Free: 1-888-TALBOYS

Fax: (856) 686-1601

Business Hours: Monday through Friday 8:30AM to 5:00PM (EST)

#### Technical Support

Talboys' technical support team is available to assist you with product recommendations, troubleshooting, regulatory compliance issues, maintenance advice or any general questions you may have **about our products and services Monday through Friday 8:30AM to 5:00PM (EST).**

Please call 1-888-TALBOYS or email [tech\\_support@talboys.com](mailto:tech_support@talboys.com).

#### Ordering, prices, shipping information, and payment terms

When ordering Talboys products, please specify part number, product description and quantity desired. Orders may be placed via phone, fax, e-mail or web. For phone orders, we require a hard copy of the purchase order be forwarded after phone order is placed.

Product appearance and specifications are current at the time of printing, and are subject to change without notice. Availability for certain products may be limited by federal, state, provincial or local licensing requirements. Offers valid in USA, void where prohibited by law or company policy, while supplies last. Visit [www.troemner.com](http://www.troemner.com) to view our privacy policy and additional disclaimers. For the most current pricing, please contact us or visit our website.

All shipments are FOB Thorofare, NJ, USA. and are shipped freight collect unless it is requested and agreed to at the time of order placement that the freight is to be prepaid and added to your invoice. Troemner will select shipping method based on weight and shipping location unless shipping instructions are provided at the time of order placement.

Shipping lead times should be confirmed at the time of the order. Lead times are estimates only and Troemner shall not be liable for non-shipment or delay due to acts of God, lightning strikes, accidents, or any other causes beyond control of Troemner, whether or not similar in class or kind to those mentioned. Troemner shall not be liable or responsible for incidental, special, or consequential damages suffered by buyer, whether foreseen or unforeseen, due to incorrect, delayed, or undelivered shipments.

Troemner accepts the following forms of payment: VISA, Mastercard, American Express, checks, money orders, and wire transfers, and are payable prior to shipment unless credit terms are established. If credit terms are requested, we require a credit application to be completed with at least 4 credit references. Credit terms are approved based on customer's acceptance of payment terms of net 30 days from the date of invoice.

Talboys, forms of Talboys and the Talboys logo and/or design are either registered trademarks or trademarks of Henry Troemner, LLC in the United States and/or other countries. All other marks referenced herein are registered trademarks, trademarks or service marks of their respective owner(s).

**Limited Warranty**

Henry Troemner, LLC agrees to correct for the original purchaser of this product, either by repair, or at Henry Troemner, LLC's election by replacement, any defects in material or workmanship which develops within the specified warranty period after delivery of this product to the original purchaser. In the event of repair, the repaired unit will be warranted for the remainder of the original specified warranty period or sixty (60) days, whichever is longer. If the product should require service, contact Henry Troemner, LLC at (856) 686-1600 or fax (856) 686-1601. This warranty shall not apply if the defect or malfunction was caused by accident, neglect, unreasonable use, improper service, or other causes not arising out of defects in material or workmanship. There are no warranties, express or implied, including, but not limited to, those of merchantability to fitness for a particular purpose, which extend beyond the description and period set forth herein. Henry Troemner, LLC's sole obligation under this warranty is limited to the repair or replacement of a defective product and Henry Troemner, LLC shall not, in any event, be liable for any incidental or consequential damages of any kind resulting from use or possession of this product. Some states do not allow (1) limitations on how long an implied warranty lasts or (2) the exclusion or limitation of incidental or consequential damages, so the above limitations or exclusions may not apply to you. This warranty gives you the specific legal rights, and you may have other rights which vary from state to state.

**Returns**

Product returns will not be accepted without a return authorization. Contact our Inside Sales Department at (856) 686-1600 or [info@talboys.com](mailto:info@talboys.com). Please have the serial number and part number of the unit to be returned, along with the reason for return. If the unit is under warranty, we will repair the faulty unit, issue a credit or send a replacement. When return for repair of a product is necessary, a return authorization number must be assigned and the product should be shipped, transportation charges prepaid, to: Henry Troemner, LLC, 201 Wolf Drive, Thorofare, NJ 08086-0087. To insure prompt handling, the return authorization number must be placed on the outside of the package and a detailed explanation of the defect enclosed with the product. Units that are claimed as being unused must be returned in their original unopened carton.

**Quality and Safety Certifications:****ISO 9001 Certification (International Organization for Standardization)**

In 1993, Troemner was one of the first companies in the Philadelphia area to achieve ISO 9001 accreditation. Troemner has a thoroughly documented quality system that ensures our customers receive the products and services they request. Troemner's ISO 9001 quality system has been audited regularly by internal, external, and customer auditors, to ensure our continued compliance with this standard. Troemner also meets ISO/IEC 17025 "General Requirements for the Competence of Testing and Calibration Laboratories."

**ISO 13485 Certification (International Organization for Standardization)**

In 2013, Troemner announced the achievement of accreditation to ISO 13485:2003 Medical devices – Quality management systems – Requirements for regulatory purposes. The company has taken the next step and is now officially registered with the FDA in the United States. Both the ISO 13485:2003 standard and the FDA 21 CFR Part 820 regulation are internationally recognized and require a thoroughly documented quality management system which focuses on the customer, management, internal procedures and processes for medical devices. By meeting the requirements of these standards, Troemner ensures they have the ability to design and manufacture Class 1 Medical Devices that consistently meet customer and regulatory requirements.

**UL (Underwriters Laboratories)**

Products with this symbol are listed by Underwriters Laboratories, Inc. and have been evaluated by UL and meet their applicable standards. UL has developed more than 800 Standards for Safety. Our Standards for Safety are essential to helping ensure public safety and confidence, reduce costs, improve quality, and market products and services. Millions of products and their components are tested to UL's rigorous safety standards with the result that consumers live in a safer environment than they would have otherwise.

**CUL listed (Canadian Underwriters Laboratory)**

UL's Certification Organization accreditation for Canada encompasses all UL global testing facilities, services, product categories and programs.

**CSA (Canadian Standards Association)**

Canadian Standards Association - Products with this symbol assure you that the product meets certain safety standards and/or performance criteria set by the Canadian Standards Association. Henry Troemner, LLC complies for the following safety standards as listed in each piece of equipment we sell.

**IEC 61010-1 (International Electrotechnical Commission)**

Safety requirements for electrical equipment for measurement control and laboratory use.

**IEC 61010-2-010 (International Electrotechnical Commission)**

Particular requirements for laboratory equipment for the heating of materials.

**IEC 61010-2-051 (International Electrotechnical Commission)**

Particular requirements for laboratory equipment for mixing and stirring.

**TUV (Technischer Überwachungs-Verein)**

TÜV SÜD is a globally recognized testing, inspection, and certification organization offering the highest quality services for a wide range of industries worldwide. A product with this symbol assures you that the product meets certain internationally recognized safety standards and/or performance criteria set by the International Electrotechnical Commission (IEC).

**CE Mark (Conformité Européenne)**

The CE mark (officially CE marking) is a mandatory safety mark on many products placed on the single market in the European Economic Area. The CE mark is a mandatory European marking for certain product groups to indicate conformity with the essential health and safety requirements set out in European Directives. To permit the use of a CE mark on a product, proof that the item meets the relevant requirements must be documented. Sometimes this is achieved using an external test house which evaluates the product and its documentation. Often it is achieved by a company-internal self-certification process. In any case the responsible organization (manufacturer, representative, importer) has to issue an EC-Declaration of Conformity (EC-DoC) indicating his identity (location, etc.), the list of European Directives he declares compliance with, a list of standards the product complies with, and a legally binding signature on behalf of the organization.

**Distributor Information:**

Talboys is always looking for distributors interested in selling our products. If you would like more information on becoming an authorized Talboys distributor, please email us at [info@talboys.com](mailto:info@talboys.com).

## Custom Manufacturing

### Custom Manufacturing & Engineering

Any product you see in this catalog can be customized to meet your specific needs. Not only can we customize standard products, we can combine technologies from several products to meet your specific application.

Troemner demonstrates excellence in all areas of the manufacturing process from design, engineering, skilled workforce, investment in capital equipment, capacity, quality assurance and customer service including:

- Engineering team with electronics, mechanical, and graphic design experience.
- ISO 9001 registered quality system to assure high reliability in both design and manufacturing processes.
- ISO 13485 accredited quality management system for the design and manufacture of Class I Medical Devices that ensures our ability to meet customer and regulatory requirements.
- Experienced regulatory processes in getting dozens of products UL, CSA, CE, and TUV approved.
- Manufacturing operation is UL and CSA approved and is "surprise" audited every 3 months according to regulatory standards.
- Turning, milling, and assembly, as well as sourcing capabilities to produce or procure components at a competitive cost.
- Calibration system is both NVLAP (NVLAP Lab Code 105013-0) and UKAS (A UKAS Accredited Calibration Laboratory No. 0516) accredited.
- Six highly trained staff metrologists who understand measurement technology and key attributes required for accurate and repeatable measurements.
- State-of-the-art facility including a modern machine shop, cellular assembly area, and the world's most environmentally stable calibration laboratories.
- Management with Six Sigma Certification.
- Responsiveness to customers needs.

If there is a single factor that defines Troemner's competitive advantage, it is our commitment and ability to respond to our customer's specific needs. Our sophisticated engineering and manufacturing capabilities allow us to address a broad range of product objectives: Designing entire product lines, introducing new products and technologies, and enhancing existing products.

### **Troemner has packaged our customer responsiveness, development, and manufacturing capabilities into the FASTrack Program.**

Troemner's FASTrack program will streamline the design and manufacturing process. After years of successful customized design and engineering projects and adhering to today's most technologically advanced manufacturing processes, Troemner has developed the FASTrack program to meet the most demanding needs of our partners. Complete with costs and timelines, the FASTrack program will streamline the entire development manufacturing process.

### The Troemner FASTrack program is a five part process:

1. Troemner will analyze your application and understand your objectives.
2. Our engineers and manufacturing experts will work with you to develop design parameters in order to meet your needs and develop a design concept.
3. A team of Troemner engineers will develop an alpha prototype to prove concept through an interactive approach with your design team.
4. After approval of concept, design details, and manufacturing costs are completed, beta prototypes are produced for testing and CE, CSA, TUV or UL approval.
5. Production commences in our ISO 9001 registered, UL, CSA approved facility and fulfillment requirements are finalized.

### Proven Technologies

Troemner has worked with industry leaders to design solutions for production and research needs across the pharmaceutical and life science industries. This experience is apparent in every product we engineer. We offer cost effective solutions to meet your customized needs.

### Flexible Systems

Troemner's state-of-the-art manufacturing facility provides our customers the ability to quickly respond to market conditions and offers the opportunity to be "first to market". All of your custom designed products will have state-of-the-art materials built in to fit your specific needs manufactured in a CSA/UL audited facility.

Listed are proven technologies that can be modified, enhanced, or incorporated as is into your customized product:

- Heating and cooling control
- Mechanical motion systems
- Digital, analog and touch screen control systems

Troemner offers in house knowledge as well as a vast network of suppliers who can support your design and manufacturing efforts. We also have experience with a variety of materials

Troemner's capabilities in design, engineering, and manufacturing can give you a distinct competitive advantage. Tell us your problems and objectives. Get us involved early in the process. Let us be part of the solution and accelerate your time to discovery.

For more information on Troemner's custom manufacturing capabilities and the FASTrack program, contact inside sales at **(856) 686-1600** or via e-mail at **[info@talboys.com](mailto:info@talboys.com)**.





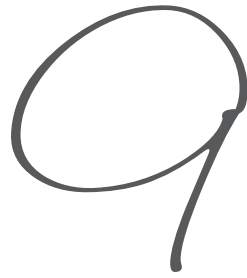





## Basic Mini Hotplates, Stirrers & Hotplate-Stirrers

- New ergonomic design
- Hotplates & Hotplate-Stirrers boil 300mL of water in 16 minutes
- Ideal for educational labs
- Built in support rod holder

Talboys Basic Mini Hotplates, Stirrers, and Hotplate-Stirrers are rugged, compact units that heat and stir up to 1000mL of liquid. Durable, cast aluminum top plate will not crack or chip, and provides an even heating surface. Bi-metallic thermostat offers reliable temperature control. Powerful heater reaches maximum temperature in only minutes. Powerful motor and magnet deliver reliable and consistent stirring. Compact design saves bench space. Built-in support rod holder with locking knob accepts optional Support Rod and Clamp Kit.

Basic Mini Fixed Temperature Hotplate features an illuminated rocker switch to activate the preset fixed temperature of 375°C.

Basic Mini Auto-Stirrer is automatically activated by the minimum weight of a beaker or flask and will stop stirring when mixing vessel is removed.

### Operating Features:

**Adjustment Knobs:** Basic speed and temperature control knobs with dial markings from 1 to 10.

### Operating Conditions:

Units can be run in conditions from 5 to 40°C (41 to 104°F), 20% to 85% relative humidity, non-condensing.

### Applications:

Academia and Basic chemistry.

### Ordering Information:

Units include a 72" (183cm), 3-wire cord and plug (230 volt units are supplied with Euro type plug). Stirrers and Hotplate-Stirrers are supplied with a 1.5" (3.8cm) PTFE coated stir bar. Additional stir bars are available for stirring models on page 74. **5 year limited warranty on parts and labor.**



### Specifications

Temperature Range	to 375°C*
Speed Range	100 to 1200rpm
Maximum Capacity (H <sub>2</sub> O)	1000mL
Top Plate Dimensions (Dia.)	5 x 5" (12.7 x 12.7cm)
Overall Dimensions (L x W x H)	7.9 x 6 x 4.9" (20.1 x 15.2 x 12.4cm)
Ship Weight	4lbs (1.8kg)

\* Fixed Temperature Hotplate has a fixed temperature of 375°C.

### Basic Mini Hotplates

Description	Electrical (50/60 Hz)	Part Number
Basic Mini Hotplate	120V   6.0 amps   565 watts	984TA5AHPUS
Basic Mini Hotplate	230V   2.5 amps   430 watts	984TA5AHPEU
Basic Mini Fixed Temperature Hotplate	120V   6.0 amps   565 watts	984TA5AFTHPUS
Basic Mini Fixed Temperature Hotplate	230V   2.5 amps   430 watts	984TA5AFTHPEU

### Basic Mini Stirrers

Description	Electrical (50/60 Hz)	Part Number
Basic Mini Stirrer	120V   0.5 amps   20 watts	984TA5ASTUS
Basic Mini Stirrer	230V   0.25 amps   20 watts	984TA5ASTEU
Basic Mini Auto-Stirrer	120V   0.5 amps   20 watts	984TA5AASTUS
Basic Mini Auto-Stirrer	230V   0.25 amps   20 watts	984TA5AASTEU

### Basic Mini Hotplate-Stirrers

Description	Electrical (50/60 Hz)	Part Number
Basic Mini Hotplate-Stirrer	120V   6.0 amps   565 watts	984TA5AHSUS
Basic Mini Hotplate-Stirrer	230V   2.5 amps   430 watts	984TA5AHSEU

## Advanced Mini Dry Block Heaters

- New ergonomic design
- 6 modular block options

The Talboys Advanced Mini Dry Block Heaters are ideal for a variety of applications that require accurate and repeatable results such as LAMP assays, immunoassays, enzyme reactions and denaturations. This personal sized heater takes up minimal bench space and is small enough to fit in the palm of your hand.

The block heater accepts one interchangeable mini block for 0.2mL, 0.5mL, 1.5mL, 2mL, 15mL, or 50mL tubes. This model includes a clear polycarbonate lid to help prevent evaporation and maintain temperature uniformity. The cover is easily removable when incubating 15mL or 50mL tubes. Efficient heater features close tube and block contact with a low density design for exceptional temperature uniformity. Units include a block lifting tool.

### Operating Features:

**Microprocessor control:** PID temperature control provides temperature accuracy as low as  $\pm 0.5^{\circ}\text{C}$  and uniformity as low as  $\pm 0.2^{\circ}\text{C}$ . Samples are heated to temperature quickly and accurately. Temperature can be adjusted in  $\pm 0.1^{\circ}\text{C}$  increments.

**LED display:** Touch pad controls with easy-to-read, independent displays for temperature and time. Provides repeatable and accurate results every time and is easily visible across lab benches. Timer will display elapsed time or, when programmed to a user defined limit, will shut off when unit reaches zero. Display will show last settings, even after power has been turned off.

**Temperature calibration mode:** Allows user to calibrate unit to an external temperature device.

### Safety Features:

**Audible alarm:** In timed mode, alarm will sound when time reaches zero and when unit reaches set-point temperature.

**Cool touch housing:** Constructed from a high quality, heat and chemical resistant polymer. The unit's housing remains cool to the touch throughout normal operating temperatures.

**CAUTION!** To avoid possible electrical hazard, do not fill well or block opening with water or other fluids. Unit is designed as a dry bath/incubator.

### Operating Conditions:

Units can be run in conditions from 18 to 33°C (64 to 91°F), 20% to 80% relative humidity, non-condensing.

### Applications:

LAMP assays, immunoassays, enzyme reactions and denaturations.



949TAMNLLUS

### Ordering Information

Unit includes a 92" (234cm) detachable, 3-wire cord and plug (230 volt units are supplied with Euro type plug). **5 year limited warranty on parts and labor.** Heaters require a Talboys mini modular block for operation (sold separately).

**Optional NIST Traceable Calibration Certificate** provided by Troemner's ISO/IEC 17025 accredited laboratory. Multiple data points within the temperature range and time function are reported on the certificate with the associated uncertainties.

### Specifications

Temperature Range	Ambient +5°C to 100°C
Temperature Accuracy	$\pm 0.5^{\circ}\text{C}$
Temperature Uniformity	$\pm 0.2^{\circ}\text{C}$
Heat-Up Time to 37°C	2 minutes
Overall Dimensions (L x W x H)	6.3 x 5 x 4.85" (16 x 12.7 x 12.3cm)
Ship Weight	3.5lbs (1.6kg)



### Description

Advanced Mini Dry Block Heater

Advanced Mini Dry Block Heater

Advanced Mini Dry Block Heater with NIST Traceable Certificate

Advanced Mini Dry Block Heater with NIST Traceable Certificate

### Electrical (50/60 Hz)

120V | 0.645 amps | 80 watts

230V | 0.325 amps | 75 watts

120V | 0.645 amps | 80 watts

230V | 0.325 amps | 75 watts

### Part Number

949TAMNLLUS

949TAMNLEU

949TAMNLLUSC

949TAMNLEUC

## Advanced Mini Dry Block Heaters with Heated Lid



- Heated lid option reduces condensation on sample lids
- Compact, ergonomic design
- 4 modular block options

The Talboys Advanced Mini Dry Block Heaters with Heated Lid are ideal for a variety of applications that require accurate and repeatable results such as LAMP assays, immunoassays, enzyme reactions and denaturations. This personal sized heater takes up minimal bench space and is small enough to fit in the palm of your hand.

The block heater accepts one interchangeable mini block for 0.2mL, 0.5mL, 1.5mL, or 2mL tubes. The heated lid helps to reduce the amount of condensation on sample lids, regulate the temperature, and maintain temperature uniformity. Efficient heater features close tube and block contact with a low density design for exceptional temperature uniformity. Units include a block lifting tool.

#### Operating Features:

**Microprocessor control:** PID temperature control provides temperature accuracy as low as  $\pm 0.3^{\circ}\text{C}$  and uniformity as low as  $\pm 0.2^{\circ}\text{C}$ . Samples are heated to temperature quickly and accurately. Temperature can be adjusted in  $\pm 0.1^{\circ}\text{C}$  increments.

**LED display:** Touch pad controls with easy-to-read, independent displays for temperature and time. Provides repeatable and accurate results every time and is easily visible across lab benches. Timer will display elapsed time or, when programmed to a user defined limit, will shut off when unit reaches zero. Display will show last settings, even after power has been turned off.

**Temperature calibration mode:** Allows user to calibrate unit to an external temperature device.

#### Safety Features:

**Audible alarm:** In timed mode, alarm will sound when time reaches zero and when unit reaches set-point temperature.

**Cool touch housing:** Constructed from a high quality, heat and chemical resistant polymer. The unit's housing remains cool to the touch throughout normal operating temperatures.

**CAUTION!** To avoid possible electrical hazard, do not fill well or block opening with water or other fluids. Unit is designed as a dry bath/incubator.

#### Operating Conditions:

Units can be run in conditions from 18 to 33°C (64 to 91°F), 20% to 80% relative humidity, non-condensing.

#### Applications:

LAMP assays, immunoassays, enzyme reactions and denaturations.



949TAMHLUS

#### Ordering Information

Unit includes a 92" (234cm) detachable, 3-wire cord and plug (230 volt units are supplied with Euro type plug). **5 year limited warranty on parts and labor.** Heaters require a Talboys mini modular block for operation (sold separately).

**Optional NIST Traceable Calibration Certificate** provided by Troemner's ISO/IEC 17025 accredited laboratory. Multiple data points within the temperature range and time function are reported on the certificate with the associated uncertainties.

Specifications	
Temperature Range	Ambient +5°C to 100°C
Temperature Accuracy	$\pm 0.3^{\circ}\text{C}$
Temperature Uniformity	$\pm 0.2^{\circ}\text{C}$
Heat-Up Time to 37°C	2 minutes
Overall Dimensions (L x W x H)	6.3 x 5 x 4.85" (16 x 12.7 x 12.3cm)
Ship Weight	3.5lbs (1.6kg)

Description	Electrical (50/60 Hz)	Part Number
Advanced Mini Dry Block Heater	120V   0.645 amps   80 watts	949TAMHLUS
Advanced Mini Dry Block Heater	230V   0.325 amps   75 watts	949TAMHLEU
Advanced Mini Dry Block Heater with NIST Traceable Certificate	120V   0.645 amps   80 watts	949TAMHLUSC
Advanced Mini Dry Block Heater with NIST Traceable Certificate	230V   0.325 amps   75 watts	949TAMHLEUC

#### Accessories for Advanced Mini Dry Block Heaters

Description	No. of Wells	Dimensions (D x W x H)	Well Depth	Thermometer Well	Part Number
Mini Block for 0.2mL Tubes	40	1.85 x 2.8 x 1.05" (4.69 x 7.11 x 2.67cm)	15.2mm	N/A	949TA02MTBLK
Mini Block for 0.5mL Tubes	24	1.85 x 2.8 x 1.15" (4.69 x 7.11 x 2.92cm)	21mm	N/A	949TA05MTBLK
Mini Block for 1.5mL Tubes	15	1.85 x 2.8 x 1.3" (4.69 x 7.11 x 3.30cm)	30.5mm	Yes	949TA15MTBLK
Mini Block for 2.0mL Tubes	15	1.85 x 2.8 x 1.3" (4.69 x 7.11 x 3.30cm)	30.5mm	N/A	949TA20MTBLK
Mini Block for 15mL Tubes*	4	1.85 x 2.8 x 2.2" (4.69 x 7.11 x 5.59cm)	72.4mm	Yes	949TA15MLBLK
Mini Block for 50mL Tubes*	2	1.85 x 2.8 x 2.2" (4.69 x 7.11 x 5.59cm)	72.4mm	Yes	949TA50MLBLK

\* Not able to be used with Advanced Mini Dry Block Heater with Heated Lid

- New ergonomic design
- Fixed high speed mixing
- Touch mode operation

New ergonomic design provides optimum comfort and minimal stress. Starts mixing when the cup head is pressed down. Speed is fixed at full rpm to provide vigorous vortexing of samples.

**Operating Conditions:**

Unit can be run in conditions from 4 to 40°C (39 to 104°F), 20% to 85% relative humidity, non-condensing.

**Ordering Information:**

Units include a 72" (183cm), 3-wire cord and plug (230 volt units are supplied with Euro type plug). Includes both cup head and 3" head with cover. Additional accessories can be found on pages 97-98. **5 year limited warranty on parts and labor.**

Description	Electrical (50/60 Hz)	Part Number
Basic Vortex Mixer	120V   1.2 amps   150 watts	9456TAFSUS
Basic Vortex Mixer	230V   0.6 amps   150 watts	9456TAFSEU



945610

**Specifications**

Speed Range*	120V 230V	3200rpm 2500rpm
Orbit	4.9mm (0.19")	
Controls	None	
Duty Rating	Intermittent duty	
Dimensions (L x W x H)	7 x 4.4 x 5.3" (17.8 x 11.2 x 13.5cm)	
Ship Weight	10lbs (4.5kg)	

\* Maximum speed will vary depending on accessory used.

- New ergonomic design
- LED displays for speed and time
- Continuous or touch mode operation

New ergonomic design provides optimum comfort and minimal stress. Ideal for applications that demand repeatable results. Microprocessor control maintains set speed for strong, consistent mixing action. Timer will display elapsed time or, when programmed to user defined time limit, the unit will shut off when time reaches zero. Two modes of operation; continuous mode when using accessory attachments or touch mode which activates mixing when depressing the cup head.

**Operating Conditions:**

Unit can be run in conditions from 4 to 40°C (39 to 104°F), 20% to 85% relative humidity, non-condensing.

**Ordering Information:**

Units include a 72" (183cm), 3-wire cord and plug (230 volt units are supplied with Euro type plug). Includes both cup head and 3" head with cover. Additional accessories can be found on pages 97-98. **5 year limited warranty on parts and labor.**

**Optional NIST Traceable Calibration Certificate** provided by Troemner's ISO/IEC 17025 accredited laboratory. Multiple data points within the speed range and time function are reported on the certificate with the associated uncertainties.



**Specifications**

Speed Range*	120V 230V	500 to 3000rpm 500 to 2500rpm
Timer	1 second to 160 hours	
Orbit	4.9mm (0.19")	
Controls	Auto/Standby/On Rocker Switch, LED Displays For Speed/Time, Up/Down Buttons For Set-Point Control	
Duty Rating	Intermittent duty	
Dimensions (L x W x H)	7 x 4.4 x 5.3" (17.8 x 11.2 x 13.5cm)	
Ship Weight	10lbs (4.5kg)	

\* Maximum speed will vary depending on accessory used.

Description	Electrical (50/60 Hz)	Part Number
Advanced Vortex Mixer	120V   1.2 amps   150 watts	9456TADGUS
Advanced Vortex Mixer	230V   0.6 amps   150 watts	9456TADGEU
Advanced Vortex Mixer with NIST Traceable Certificate	120V   1.2 amps   150 watts	9456TADGUSC
Advanced Vortex Mixer with NIST Traceable Certificate	230V   0.6 amps   150 watts	9456TADGEUC

## Standard and Pulsing Vortex Mixers



- New ergonomic design
- Variable, analog speed control
- Continuous or touch mode operation

New ergonomic design provides optimum comfort and minimal stress. Control allows low rpm startup for gentle shaking or high speed mixing for vigorous vortexing of samples. Two modes of operation; continuous mode when using accessory attachments or touch mode which activates mixing when depressing the cup head.

### Operating Conditions:

Unit can be run in conditions from 4 to 40°C (39 to 104°F), 20% to 85% relative humidity, non-condensing.

### Ordering Information:

Units include a 72" (183cm), 3-wire cord and plug (230 volt units are supplied with Euro type plug). Includes both cup head and 3" head with cover. Additional accessories can be found on pages 97-98. **5 year limited warranty on parts and labor.**

Description	Electrical (50/60 Hz)	Part Number
Standard Vortex Mixer	120V   1.2 amps   150 watts	9456TAALUS
Standard Vortex Mixer	230V   0.6 amps   150 watts	9456TAALEU

- New ergonomic design
- LED displays for time and speed
- Glass bead cell disruption/homogenization

New ergonomic design provides optimum comfort and minimal stress. Powerful pulsing vortex action produces excellent cell disruption for glass bead procedures. Capable of complete cell disruption of samples in only minutes. Unique pulsing action reduces heat generation while providing more effective mixing and disruption. Displayed time counts up during continuous operation and counts down during timed runs.

### Operating Conditions:

Unit can be run in conditions from 4 to 40°C (39 to 104°F), 20% to 85% relative humidity, non-condensing.

### Ordering Information:

Units include a 72" (183cm), 3-wire cord and plug (230 volt units are supplied with Euro type plug). Includes cup head, 3" head with cover, and an easy-to-load 1.5mL to 2mL Micro-Tube Holder. Holder has a built-in cup head. Additional accessories can be found on pages 97-98. **5 year limited warranty on parts and labor.**

**Optional NIST Traceable Calibration Certificate** provided by Troemner's ISO/IEC 17025 accredited laboratory. Multiple data points within the speed range and time function are reported on the certificate with the associated uncertainties.

Description	Electrical (50/60 Hz)	Part Number
Pulsing Vortex Mixer	120V   1.2 amps   150 watts	9456TAPSUS
Pulsing Vortex Mixer	230V   0.6 amps   150 watts	9456TAPSEU
Pulsing Vortex Mixer with NIST Traceable Certificate	120V   1.2 amps   150 watts	9456TAPSUC
Pulsing Vortex Mixer with NIST Traceable Certificate	230V   0.6 amps   150 watts	9456TAPSEUC



945600

### Specifications

Speed Range*	120V 230V	300 to 3200rpm 300 to 2500rpm
Orbit		4.9mm (0.19")
Controls		Auto/Off/On Rocker Switch, Speed Knob: Variable 1 to 10 Dial Marks
Duty Rating		Intermittent duty
Dimensions (L x W x H)		7 x 4.4 x 5.3" (17.8 x 11.2 x 13.5cm)
Ship Weight		10lbs (4.5kg)

\* Maximum speed will vary depending on accessory used.



### Specifications

Speed Range*	120V 230V	500 to 3000rpm 500 to 2500rpm
Timer		1 second to 160 hours
Orbit		2.5mm (0.098")
Controls		Auto/Standby/On Rocker Switch, LED Displays For Speed/Time, Up/Down Buttons For Set-Point Control Pulse Button
Duty Rating		Intermittent duty
Dimensions (L x W x H)		7 x 4.4 x 5.3" (17.8 x 11.2 x 13.5cm)
Ship Weight		10lbs (4.5kg)

\* Maximum speed will vary depending on accessory used.







17

## Open-Air Shaker Selection Guide



Standard 3500  
Orbital Shaker



Advanced 3500  
Orbital Shaker



Advanced Dura-Shaker  
for CO<sub>2</sub>



Advanced 3750  
Reciprocating Shaker

	Standard 3500 Orbital Shaker	Advanced 3500 Orbital Shaker	Advanced Dura-Shaker for CO <sub>2</sub>	Advanced 3750 Reciprocating Shaker
<b>Speed Range</b>	25 to 500rpm	15 to 500rpm	15 to 500rpm	20 to 300rpm
<b>Timer</b>	1 to 120 minutes	1 second to 160 hours	1 second to 160 hours	1 second to 160 hours
<b>Motion</b>	Orbital	Orbital	Orbital	Reciprocating
<b>Orbit</b>	19mm	19mm	19mm	Stroke: 19mm
<b>Max Weight Capacity</b>	35lbs	35lbs	35lbs	15lbs
<b>Audible Alarm</b>	-	●	●	●
<b>Load Sensor</b>	-	●	●	●
<b>Motor Type</b>	Brushless DC Motor	Brushless DC Motor	Brushless DC Motor	Brushless DC Motor
<b>CO<sub>2</sub> Environment</b>	●	●	●	●
<b>Overload Protection</b>	-	●	●	●
<b>User Calibration (Speed)</b>	-	●	●	●
<b>RS-232 Interface</b>	-	●	●	●
<b>Included Tray (L x W)</b>	11 x 13"	11 x 13"	11 x 13"	11 x 13"
<b>Tray / Platform Options (L x W)</b>	11 x 13", 13 x 13", 18 x 18", 18 x 24" Adjustable Platform Separatory Funnel Platform	11 x 13", 13 x 13", 18 x 18", 18 x 24" Adjustable Platform Separatory Funnel Platform	11 x 13", 13 x 13", 18 x 18", 18 x 24" Adjustable Platform Separatory Funnel Platform	11 x 13", 13 x 13", 18 x 18", 18 x 24" Adjustable Platform Separatory Funnel Platform



Advanced 15000-2  
Orbital Shaker



Standard 1000  
Orbital Shaker



Advanced 1000-3  
Orbital Shaker



Advanced 1000-15  
Orbital Shaker

	Advanced 15000-2 Orbital Shaker	Standard 1000 Orbital Shaker	Advanced 1000-3 Orbital Shaker	Advanced 1000-15 Orbital Shaker
<b>Speed Range</b>	15 to 300rpm	40 to 300rpm	100 to 1200rpm	40 to 300rpm
<b>Timer</b>	1 second to 160 hours	N/A	1 second to 160 hours	1 second to 160 hours
<b>Motion</b>	Orbital	Orbital	Orbital	Orbital
<b>Orbit</b>	51mm	15mm	3mm	15mm
<b>Max Weight Capacity</b>	150lbs	8lbs	8lbs	8lbs
<b>Audible Alarm</b>	●	-	●	●
<b>Load Sensor</b>	●	-	-	-
<b>Motor Type</b>	Brushless DC Motor	Brushless DC Motor	Brushless DC Motor	Brushless DC Motor
<b>CO<sub>2</sub> Environment</b>	●	●	●	●
<b>Overload Protection</b>	●	-	●	●
<b>User Calibration (Speed)</b>	●	-	-	-
<b>RS-232 Interface</b>	●	-	-	-
<b>Included Tray (L x W)</b>	24 x 36"	11.75 x 8.75"	11.75 x 8.75"	11.75 x 8.75"
<b>Tray / Platform Options (L x W)</b>	24 x 36" Large Vessel Carrier Platform	N/A	Adjustable Platform	Adjustable Platform

● Yes

Open-Air Shaker Selection Guide



Standard 5000  
Orbital Shaker

25 to 500rpm  
1 to 120 minutes  
Orbital  
25mm  
50lbs  
-  
-  
Brushless DC Motor  
●  
-  
-  
-  
18 x 24"  
18 x 24", 18 x 30"  
Adjustable Platform  
Large Vessel Carrier Platform



Advanced 5000  
Orbital Shaker

20 to 500rpm  
1 second to 160 hours  
Orbital  
25mm  
50lbs  
●  
●  
Brushless DC Motor  
●  
●  
●  
●  
18 x 24"  
18 x 24", 18 x 30"  
Adjustable Platform  
Large Vessel Carrier Platform



Advanced 10000-1  
Orbital Shaker

15 to 500rpm  
1 second to 160 hours  
Orbital  
25mm  
100lbs  
●  
●  
Brushless DC Motor  
●  
●  
●  
●  
24 x 24"  
24 x 24"  
Large Vessel Carrier Platform



Advanced 10000-2  
Orbital Shaker

15 to 300rpm  
1 second to 160 hours  
Orbital  
51mm  
100lbs  
●  
●  
Brushless DC Motor  
●  
●  
●  
●  
24 x 24"  
24 x 24"  
Large Vessel Carrier Platform



Advanced 15000-1  
Orbital Shaker

15 to 500rpm  
1 second to 160 hours  
Orbital  
25mm  
150lbs  
●  
●  
Brushless DC Motor  
●  
●  
●  
●  
24 x 36"  
24 x 36"  
Large Vessel Carrier Platform



Advanced 1000MP  
Microplate Orbital Shaker

100 to 1200rpm  
1 second to 160 hours  
Orbital  
3mm  
4 microplates / 2 micro-tube racks  
●  
-  
Brushless DC Motor  
●  
●  
-  
-  
11 x 7.75"  
N/A



Advanced High Speed  
Microplate Shaker

600 to 2500rpm  
1 second to 160 hours  
Orbital  
3.6mm  
48 microplates  
-  
-  
DC Motor  
-  
-  
●  
11 x 12.25"  
N/A



Standard 1000RS  
Rocking Shaker

1 to 75rpm\*  
1 minute to 120 minutes  
Rocking  
Tilt Angle: 0 to 15° \*  
16lbs\*\*  
-  
-  
Stepper Motor  
-  
-  
-  
14 x 11"  
Stacking Tray



Advanced 1000RS  
Rocking Shaker

1 to 50rpm\*  
1 second to 160 hours  
Rocking  
Tilt Angle: 0 to 15° \*  
10lbs\*\*  
●  
-  
Stepper Motor  
●  
●  
-  
-  
12.75 x 10"  
Stacking Tray



Advanced 1000WS  
Waving Shaker

1 to 30rpm\*  
1 second to 160 hours  
Waving  
Tilt Angle: 0 to 20° \*  
5lbs\*\*  
●  
-  
Stepper Motor  
●  
●  
-  
-  
11.75 x 8.75"  
Stacking Tray

● Yes

\* Maximum speed/tilt angle may vary with heavy or unbalanced loads  
\*\* Centered on tray.

## Standard 3500 Orbital Shaker

- Microprocessor controls
- Continuous or timed operation
- 35lb weight capacity

The Talboys Standard 3500 Orbital Shaker is designed for a wide range of applications that require basic shaking control. Shaker provides reproducible motion that is evenly distributed throughout the entire surface of the tray.

### Operating Features:

**Microprocessor Control:** The variable speed microprocessor control provides consistent uniform shaking action. The shaker will automatically restart after a power interruption.

**Triple Eccentric Drive:** Permanently lubricated ball bearings and maintenance free, brushless DC motor provide reliable service and continuous duty operation.

**Adjustment Knobs:** Basic speed and time knobs with dial settings from 1 to 10.

### Safety Features:

**Speed Ramping Feature:** Slowly increases speed to desired set-point to avoid splashing.

**Spill-Resistant Design:** Channels fluids away from internal components.

### Operating Conditions:

Unit can be run in cold rooms, incubators, and CO<sub>2</sub> environments from 0 to 40°C (32 to 104°F), maximum 80% relative humidity, non-condensing.

### Applications:

Bacterial suspensions, staining/destaining, and general mixing.

### Ordering Information

Unit includes a 92" (234cm) detachable, 3-wire cord and plug (230 volt units are supplied with Euro type plug). Unit is also supplied with an 11 x 13" (27.9 x 33cm) non-skid rubber mat. **5 year limited warranty on parts and labor.**



980401 with platform 980169

Specifications	
Speed Range	25 to 500rpm
Timer	1 minute to 120 minutes
Orbit	19mm (0.75")
Maximum Weight Capacity	35lbs (16kg)
Tray Material	Aluminum
Tray Dimensions (L x W)	11 x 13" (27.9 x 33cm)
Overall Dimensions (L x W x H)	16.25 x 14 x 5.75" (41.3 x 35.6 x 14.6cm)
Ship Weight	49lbs (22.2kg)

Description	Electrical (50/60 Hz)	Part Number
Standard 3500 Orbital Shaker	120V   5.0 amps   75 watts	980401
Standard 3500 Orbital Shaker	230V   2.5 amps   75 watts	980402

## Advanced 3500 Orbital Shaker &amp; Advanced 3750 Reciprocating Shaker



- Exceptional speed control, accuracy and durability
- LED displays for speed and time
- Calibration mode for speed

The Talboys Advanced 3500 Orbital Shaker and the Advanced 3750 Reciprocating Shaker are designed for a wide range of applications, including cell cultures, that require accurate and repeatable results. The microprocessor control provides consistent uniform shaking while safely ramping to the set speed.

#### Operating Features:

**Accu-Drive Shaking System:** The exclusive patented Accu-Drive Shaking System delivers exceptional speed control, accuracy, and durability (Advanced 3500). The shaking system in both models continuously monitors shaking speed and maintains set-point, even under changing loads. When unit is set to a speed above 100rpm, the speed accuracy is  $\pm 1\%$  of set speed. When set under 100rpm, speed accuracy is  $\pm 1$ rpm.

**Microprocessor Control:** The variable speed microprocessor control provides consistent uniform shaking action. Microprocessor will display last set-point and will restart if power is interrupted.

**Triple Eccentric Drive:** Permanently lubricated ball bearings and maintenance free, brushless DC motor provide reliable service and continuous duty operation (3500 Orbital Shaker only).

**Single Eccentric Drive:** Permanently lubricated ball bearings and maintenance free, brushless DC motor provide reliable service and continuous duty operation (3750 Orbital Shaker only).

**LED Display:** Touch pad controls with easy-to-read, independent LED displays for speed and time allow operator to view both settings at once. Provides repeatable and accurate results every time and is easily visible across lab benches. Timer will display elapsed time or, when programmed to user defined limit, will shut off unit when time reaches zero. Display will show last used settings, even after power has been turned off.

**RS-232 Interface:** Provides two-way communication for data logging and unit control.

**Speed Calibration Mode:** Allows user to automatically recalibrate speed display.

#### Safety Features:

**Load Sensor:** A built-in load sensor detects unbalanced conditions and automatically reduces rpm to a safe speed to protect samples.

**Overload Protection:** Audible and visual signals will activate when system detects an obstruction or overload of the tray.

**Speed Ramping Feature:** Slowly increases speed to desired set-point to avoid splashing.

**Audible Alarm:** In timed mode, alarm will sound when the time reaches zero. Alarm has optional mute function which can be set from the touch pad control.

**Spill-Resistant Design:** Channels fluids away from internal components.



980407 with platform 980457

#### Operating Conditions:

Unit can be run in cold rooms, incubators, and CO<sub>2</sub> environments from -10 to 60°C (14 to 140°F), maximum 80% relative humidity, non-condensing.

#### Applications:

Cell cultures, solubility studies, and extraction procedures.

#### Ordering Information

Unit includes a 92" (234cm) detachable, 3-wire cord and plug (230 volt units are supplied with Euro type plug). Unit is also supplied with an 11 x 13" (27.9 x 33cm) non-skid rubber mat. **5 year limited warranty on parts and labor.**

**Optional NIST Traceable Calibration Certificate** provided by Troemner's ISO/IEC 17025 accredited laboratory. Multiple data points within the speed range and time function are reported on the certificate with the associated uncertainties.

Specifications	
Speed Range	
Advanced 3500	15 to 500rpm
Advanced 3750	20 to 300rpm
Speed Accuracy	above 100rpm $\pm 1\%$ of set speed below 100rpm $\pm 1$ rpm
Timer	1 second to 160 hours
Motion	
Advanced 3500, orbital	19mm (0.75") orbit
Advanced 3750, reciprocating	19mm (0.75") stroke
Maximum Weight Capacity	
Advanced 3500	35lbs (16kg)
Advanced 3750	15lbs (6.8kg)
Tray Material	Aluminum
Tray Dimensions (L x W)	11 x 13" (27.9 x 33cm)
Overall Dimensions (L x W x H)	23.5 x 14 x 5.75" (41.3 x 35.6 x 14.6cm)
Ship Weight	49lbs (22.2kg)

Description	Electrical (50/60 Hz)	Part Number
Advanced 3500 Orbital Shaker	120V   5.0 amps   75 watts	980403
Advanced 3500 Orbital Shaker	230V   2.5 amps   75 watts	980404
Advanced 3750 Reciprocating Shaker	120V   5.0 amps   40 watts	980407
Advanced 3750 Reciprocating Shaker	230V   2.5 amps   40 watts	980408
Advanced 3500 Orbital Shaker with NIST Traceable Certificate	120V   5.0 amps   75 watts	980403-C
Advanced 3500 Orbital Shaker with NIST Traceable Certificate	230V   2.5 amps   75 watts	980404-C
Advanced 3750 Reciprocating Shaker with NIST Traceable Certificate	120V   5.0 amps   40 watts	980407-C
Advanced 3750 Reciprocating Shaker with NIST Traceable Certificate	230V   2.5 amps   40 watts	980408-C

- Designed for use in CO<sub>2</sub> Incubators
- Can withstand extreme environments up to 100% humidity
- Remote controller magnetically attaches to most incubators

The Talboys Dura Shaker is designed for a wide range of applications including cell cultures that require CO<sub>2</sub> and humidity for optimal cell growth. The microprocessor control provides consistent uniform shaking while safely ramping to the set speed.

### Operating Features:

**Accu-Drive Shaking System:** The exclusive patented Accu-Drive Shaking System delivers exceptional speed control, accuracy, and durability (Advanced 3500). The shaking system in both models continuously monitors shaking speed and maintains set-point, even under changing loads. When unit is set to a speed above 100rpm, the speed accuracy is  $\pm 1\%$  of set speed. When set under 100rpm, speed accuracy is  $\pm 1$ rpm.

**Microprocessor Control:** The variable speed microprocessor control provides consistent uniform shaking action. Microprocessor will display last set-point and will restart if power is interrupted.

**Triple Eccentric Drive:** Permanently lubricated ball bearings and maintenance free, brushless DC motor provide reliable service and continuous duty operation (3500 Orbital Shaker only).

**Remote Controller:** The control module is designed to sit outside of the incubator. Settings can be easily viewed or changed from outside of the incubator without disturbing the incubator's atmosphere. The thin ribbon cable is 5.5 feet long and easily passes underneath an incubator door via incubator's utility port. Controller magnetically attaches to most incubator doors or can sit on a lab bench.

**Single Eccentric Drive:** Permanently lubricated ball bearings and maintenance free, brushless DC motor provide reliable service and continuous duty operation (3750 Orbital Shaker only).

**LED Display:** Touch pad controls with easy-to-read, independent LED displays for speed and time allow operator to view both settings at once. Provides repeatable and accurate results every time and is easily visible across lab benches. Timer will display elapsed time or, when programmed to user defined limit, will shut off unit when time reaches zero. Display will show last used settings, even after power has been turned off.

**RS-232 Interface:** Provides two-way communication for data logging and unit control.

**Speed Calibration Mode:** Allows user to automatically recalibrate speed display.

### Safety Features:

**Overload Protection:** Audible and visual signals will activate when system detects an obstruction.

**Speed Ramping Feature:** Slowly increases speed to desired set-point to avoid splashing.

**Audible Alarm:** In timed mode, alarm will sound when the time reaches zero. Alarm has optional mute function which can be set from the touch pad control.

**Spill-Resistant Design:** Channels fluids away from internal components.

### Operating Conditions:

Unit can be run in cold rooms, incubators, and CO<sub>2</sub> environments from -10 to 60°C (14 to 140°F), up to 100% humidity.



980403C02

### Applications:

Cell cultures, solubility studies, and extraction procedures.

### Ordering Information

Unit includes a 92" (234cm) detachable, 3-wire cord and plug (230 volt units are supplied with Euro type plug). Unit is also supplied with an 11 x 13" (27.9 x 33cm) non-skid rubber mat. **5 year limited warranty on parts and labor.**

**Optional NIST Traceable Calibration Certificate** provided by Troemner's ISO/IEC 17025 accredited laboratory. Multiple data points within the speed range and time function are reported on the certificate with the associated uncertainties.

Specifications	
Speed Range	15 to 500rpm
Speed Accuracy	above 100rpm $\pm 1\%$ of set speed below 100rpm $\pm 1$ rpm
Timer	1 second to 160 hours
Orbit	0.75" (19mm)
Maximum Weight Capacity	35lbs (16kg)
Tray Material	Aluminum
Tray Dimensions (L x W)	11 x 13" (27.9 x 33cm)
Overall Dimensions (L x W x H)	Shaker 11.85 x 14 x 6.1" (30.1 x 35.6 x 15.4cm)
	Remote 5.3 x 14 x 4.6" (13.5 x 35.6 x 11.6cm)
Ship Weight	49lbs (22.2kg)

Description	Electrical (50/60 Hz)	Part Number
Advanced Dura-Shaker	120V   0.5 amps   30 watts	980403C02
Advanced Dura-Shaker	230V   0.3 amps   30 watts	980404C02
Advanced Dura-Shaker with NIST Traceable Certificate	120V   0.5 amps   30 watts	980403C02C
Advanced Dura-Shaker with NIST Traceable Certificate	230V   0.3 amps   30 watts	980404C02C

## Standard 5000 Orbital Shaker



- **Microprocessor controls**
- **Continuous or timed operation**
- **50lb weight capacity**

The Talboys Standard 5000 Orbital Shaker is designed for applications with heavy duty loads. Shaker provides reproducible motion that is evenly distributed throughout the entire surface of the tray.

#### Operating Features:

**Microprocessor Control:** The variable speed microprocessor control provides consistent uniform shaking action. The shaker will automatically restart after a power interruption.

**Triple Eccentric Drive:** Permanently lubricated ball bearings and maintenance free, brushless DC motor provide reliable service and continuous duty operation.

**Adjustment Knobs:** Basic speed and time knobs with dial settings from 1 to 10.

#### Safety Features:

**Speed Ramping Feature:** Slowly increases speed to desired set-point to avoid splashing.

**Spill-Resistant Design:** Channels fluids away from internal components.

#### Operating Conditions:

Unit can be run in cold rooms, incubators, and CO<sub>2</sub> environments from 0 to 40°C (32 to 104°F), maximum 80% relative humidity, non-condensing.

#### Applications:

Bacterial suspensions, staining/destaining, and general mixing.

#### Ordering Information

Units include a 92" (234cm) detachable, 3-wire cord and plug (230 volt units are supplied with Euro type plug). Units are also supplied with an 18 x 24" (45.7 x 61cm) non-skid rubber mat. **5 year limited warranty on parts and labor.**



980410 with platform 980443

Specifications	
Speed Range	25 to 500rpm
Timer	1 minute to 120 minutes
Orbit	25mm (1")
Maximum Weight Capacity	50lbs (22.7kg)
Tray Material	Aluminum
Tray Dimensions	18 x 24" (45.7 x 61cm)
Overall Dimensions (L x W x H)	23.5 x 26.7 x 6.0" (59.7 x 67.8 x 15.2cm)
Ship Weight	109lbs (49.5kg)

Description	Electrical (50/60 Hz)	Part Number
Standard 5000 Orbital Shaker	120V   5.0 amps   75 watts	980410
Standard 5000 Orbital Shaker	230V   2.5 amps   75 watts	980411

- Patented Accu-Drive Shaking System
- LED displays for speed and time
- 50lb weight capacity

The Talboys Advanced 5000 Orbital Shaker is designed for a wide range of applications with larger or heavier loads that require accurate and repeatable results.

### Operating Features:

**Accu-Drive Shaking System:** The exclusive patented Accu-Drive Shaking System delivers exceptional speed control, accuracy, and durability. The shaking system continuously monitors shaking speed and maintains set-point, even under changing loads. When unit is set to a speed above 100rpm, the speed accuracy is  $\pm 1\%$  of set speed. When set under 100rpm, speed accuracy is  $\pm 1$  rpm.

**Microprocessor Control:** The variable speed microprocessor control provides consistent uniform shaking action. Microprocessor will display last set-point and will restart if power is interrupted.

**Triple Eccentric Drive:** Permanently lubricated ball bearings and maintenance free, brushless DC motor provide reliable service and continuous duty operation.

**LED Display:** Touch pad controls with easy-to-read, independent LED displays for speed and time allow operator to view both settings at once. Provides repeatable and accurate results every time and is easily visible across lab benches. Timer will display elapsed time or, when programmed to user defined limit, will shut off unit when time reaches zero. Display will show last used settings, even after power has been turned off.

**RS-232 Interface:** Provides two-way communication for data logging and unit control.

**Speed Calibration Mode:** Allows user to automatically recalibrate speed display.

### Safety Features:

**Load Sensor:** A built-in load sensor detects unbalanced conditions and automatically reduces rpm to a safe speed to protect samples.

**Overload Protection:** Audible and visual signals will activate when system detects an obstruction or overload of the tray.

**Speed Ramping Feature:** Slowly increases speed to desired set-point to avoid splashing.

**Audible Alarm:** In timed mode, alarm will sound when the time reaches zero. Alarm has optional mute function which can be set from the touch pad control.

**Spill-Resistant Design:** Channels fluids away from internal components.

### Operating Conditions:

Unit can be run in cold rooms, incubators, and CO<sub>2</sub> environments from -10 to 60°C (14 to 140°F), maximum 80% relative humidity, non-condensing.

### Applications:

Cell cultures, solubility studies, and extraction procedures.

### Ordering Information

Units include a 92" (234cm) detachable, 3-wire cord and plug (230 volt units are supplied with Euro type plug). Units are also supplied with an 18 x 24" (45.7 x 61cm) non-skid rubber mat. **5 year limited warranty on parts and labor.**



980412 with platform 980436

**Optional NIST Traceable Calibration Certificate** provided by Troemner's ISO/IEC 17025 accredited laboratory. Multiple data points within the speed range and time function are reported on the certificate with the associated uncertainties.

Specifications	
Speed Range	20 to 500rpm
Speed Accuracy	above 100rpm $\pm 1\%$ of set speed below 100rpm $\pm 1$ rpm
Timer	1 second to 160 hours
Orbit	25mm (1")
Maximum Weight Capacity	50lbs (22.7kg)
Tray Material	Aluminum
Tray Dimensions	18 x 24" (45.7 x 61cm)
Overall Dimensions (L x W x H)	23.6 x 26.7 x 6.0" (59.9 x 67.8 x 15.2cm)
Ship Weight	109lbs (49.5kg)

Description	Electrical (50/60 Hz)	Part Number
Advanced 5000 Orbital Shaker	120V   5.0 amps   75 watts	980412
Advanced 5000 Orbital Shaker	230V   2.5 amps   75 watts	980413
Advanced 5000 Orbital Shaker with NIST Traceable Certificate	120V   5.0 amps   75 watts	980412-C
Advanced 5000 Orbital Shaker with NIST Traceable Certificate	230V   2.5 amps   75 watts	980413-C



## Advanced 10000 Orbital Shakers



- Patented Accu-Drive Shaking System
- 100lb weight capacity
- Available with either 1" or 2" orbit

Talboys Advanced 10000-1 and 10000-2 Orbital Shakers are large capacity shakers. They have a more powerful drive mechanism and larger orbits for optimal shaking of large vessels.

#### Operating Features:

**Accu-Drive Shaking System:** The exclusive patented Accu-Drive Shaking System delivers exceptional speed control, accuracy, and durability. The shaking system continuously monitors shaking speed and maintains set-point, even under changing loads. When unit is set to a speed above 100rpm, the speed accuracy is  $\pm 1\%$  of set speed. When set under 100rpm, speed accuracy is  $\pm 1$ rpm.

**Microprocessor Control:** The variable speed microprocessor control provides consistent uniform shaking action. Microprocessor will display last set-point and will restart if power is interrupted.

**Triple Eccentric Drive:** Permanently lubricated ball bearings and maintenance free, brushless DC motor provide reliable service and continuous duty operation.

**LED Display:** Touch pad controls with easy-to-read, independent LED displays for speed and time allow operator to view both settings at once. Provides repeatable and accurate results every time and is easily visible across lab benches. Timer will display elapsed time or, when programmed to user defined limit, will shut off unit when time reaches zero. Display will show last used settings, even after power has been turned off.

**RS-232 Interface:** Provides two-way communication for data logging and unit control.

**Speed Calibration Mode:** Allows user to automatically recalibrate speed display.

#### Safety Features:

**Load Sensor:** A built-in load sensor detects unbalanced conditions and automatically reduces rpm to a safe speed to protect samples.

**Overload Protection:** Audible and visual signals will activate when system detects an obstruction or overload of the tray.

**Speed Ramping Feature:** Slowly increases speed to desired set-point to avoid splashing.

**Audible Alarm:** In timed mode, alarm will sound when the time reaches zero. Alarm has optional mute function which can be set from the touch pad control.

**Spill-Resistant Design:** Channels fluids away from internal components.

#### Operating Conditions:

Units can be run in cold rooms, incubators, and CO<sub>2</sub> environments from -10 to 60°C (14 to 140°F), maximum 80% relative humidity, non-condensing.

#### Applications:

Cell cultures, solubility studies, and extraction procedures.



#### Ordering Information

Units include a 92" (234cm) detachable, 3-wire cord and plug (230 volt units are supplied with Euro type plug). Units are also supplied with a 24 x 24" (61 x 61 cm) non-skid rubber mat. **5 year limited warranty on parts and labor.**

**Optional NIST Traceable Calibration Certificate** provided by Troemner's ISO/IEC 17025 accredited laboratory. Multiple data points within the speed range and time function are reported on the certificate with the associated uncertainties.

Specifications	
Speed Range	
10000-1	15 to 500rpm
10000-2	15 to 300rpm
Speed Accuracy	above 100rpm $\pm 1\%$ of set speed below 100rpm $\pm 1$ rpm
Timer	1 second to 160 hours
Orbit	
10000-1	25mm (1")
10000-2	51mm (2")
Maximum Weight Capacity	100lbs (45.4kg)
Tray Material	Aluminum
Tray Dimensions (L x W)	24 x 24" (61 x 61 cm)
Overall Dimensions (L x W x H)	28.25 x 26.7 x 7" (71.8 x 67.8 x 17.8cm)
Ship Weight	200lbs (90.8kg)

Description	Electrical (50/60 Hz)	Part Number
Advanced 10000-1 Orbital Shaker	120V   5.0 amps   80 watts	980420
Advanced 10000-1 Orbital Shaker	230V   2.5 amps   80 watts	980421
Advanced 10000-2 Orbital Shaker	120V   5.0 amps   80 watts	980422
Advanced 10000-2 Orbital Shaker	230V   2.5 amps   80 watts	980423
Advanced 10000-1 Orbital Shaker with NIST Traceable Certificate	120V   5.0 amps   80 watts	980420-C
Advanced 10000-1 Orbital Shaker with NIST Traceable Certificate	230V   2.5 amps   80 watts	980421-C
Advanced 10000-2 Orbital Shaker with NIST Traceable Certificate	120V   5.0 amps   80 watts	980422-C
Advanced 10000-2 Orbital Shaker with NIST Traceable Certificate	230V   2.5 amps   80 watts	980423-C

- Patented Accu-Drive Shaking System
- Available with either 1" or 2" orbit
- Calibration mode for speed

Talboys Advanced 15000-1 and 15000-2 Orbital Shakers are the largest capacity shakers designed for the heaviest of loads. They have the most powerful drive mechanism of all the shakers and large orbits for optimal shaking of larger vessels.

### Operating Features:

**Accu-Drive Shaking System:** The exclusive patented Accu-Drive Shaking System delivers exceptional speed control, accuracy, and durability. The system continuously monitors shaking speed and maintains set-point, even under changing loads. When unit is set to a speed above 100rpm, the speed accuracy is  $\pm 1\%$  of set speed. When set under 100rpm, speed accuracy is  $\pm 1$ rpm.

**Microprocessor Control:** The variable speed microprocessor control provides consistent uniform shaking action. Microprocessor will display last set-point and will restart if power is interrupted.

**Triple Eccentric Drive:** Permanently lubricated ball bearings and maintenance free, brushless DC motor provide reliable service and continuous duty operation.

**LED Display:** Touch pad controls with easy-to-read, independent LED displays for speed and time allow operator to view both settings at once. Provides repeatable and accurate results every time and is easily visible across lab benches. Timer will display elapsed time or, when programmed to user defined limit, will shut off unit when time reaches zero. Display will show last used settings, even after power has been turned off.

**RS-232 Interface:** Provides two-way communication for data logging and unit control.

**Speed Calibration Mode:** Allows user to automatically recalibrate speed display.

### Safety Features:

**Load Sensor:** A built-in load sensor detects unbalanced conditions and automatically reduces rpm to a safe speed to protect samples.

**Overload Protection:** Audible and visual signals will activate when system detects an obstruction or overload of the tray.

**Speed Ramping Feature:** Slowly increases speed to desired set-point to avoid splashing.

**Audible Alarm:** In timed mode, alarm will sound when the time reaches zero. Alarm has optional mute function which can be set from the touch pad control.

**Spill-Resistant Design:** Channels fluids away from internal components.

### Operating Conditions:

Units can be run in cold rooms, incubators, and CO<sub>2</sub> environments from -10 to 60°C (14 to 140°F), maximum 80% relative humidity, non-condensing.

### Applications:

Cell cultures, solubility studies, and extraction procedures.



980424 with platform 980439

### Ordering Information

Units include a 92" (234cm) detachable, 3-wire cord and plug (230 volt units are supplied with Euro type plug). Units are also supplied with a 24 x 36" (61 x 91cm) non-skid rubber mat. **5 year limited warranty on parts and labor.**

**Optional NIST Traceable Calibration Certificate** provided by Troemner's ISO/IEC 17025 accredited laboratory. Multiple data points within the speed range and time function are reported on the certificate with the associated uncertainties.

### Specifications

Speed Range	15000-1	15 to 500rpm
	15000-2	15 to 300rpm
Speed Accuracy		above 100rpm $\pm 1\%$ of set speed below 100rpm $\pm 1$ rpm
Timer		1 second to 160 hours
Orbit	15000-1	25mm (1")
	15000-2	51mm (2")
Maximum Weight Capacity		150lbs (68kg)
Tray Material		Aluminum
Tray Dimensions (L x W)		24 x 36" (61 x 91cm)
Overall Dimensions (L x W x H)		28.3 x 26.7 x 7" (71.8 x 67.8 x 17.8cm)
Ship Weight		230lbs (104.4kg)

Description	Electrical (50/60 Hz)	Part Number
Advanced 15000-1 Orbital Shaker	120V   5.0 amps   80 watts	980424
Advanced 15000-1 Orbital Shaker	230V   2.5 amps   80 watts	980425
Advanced 15000-2 Orbital Shaker	120V   5.0 amps   80 watts	980426
Advanced 15000-2 Orbital Shaker	230V   2.5 amps   80 watts	980427
Advanced 15000-1 Orbital Shaker with NIST Traceable Certificate	120V   5.0 amps   80 watts	980424-C
Advanced 15000-1 Orbital Shaker with NIST Traceable Certificate	230V   2.5 amps   80 watts	980425-C
Advanced 15000-2 Orbital Shaker with NIST Traceable Certificate	120V   5.0 amps   80 watts	980426-C
Advanced 15000-2 Orbital Shaker with NIST Traceable Certificate	230V   2.5 amps   80 watts	980427-C

## Standard 1000 Orbital Shaker



- Variable speed microprocessor control
- Low profile design
- 15mm orbit

The Talboys Standard 1000 Orbital Shaker is an economical shaker designed for educational labs or basic shaking applications.

**Operating Features:**

**Low Profile Design:** Takes up less space and easily fits into most hoods and incubators. Cast aluminum base offers durability and added stability.

**Microprocessor Control:** The variable speed microprocessor control provides consistent uniform shaking action.

**Triple Eccentric Drive:** Permanently lubricated ball bearings and maintenance free, brushless DC motor provide reliable service and continuous duty operation.

**Adjustment Knob:** Basic speed knob with dial settings from 1 to 10.

**Safety Features:**

**Speed Ramping Feature:** Slowly increases speed to desired set-point to avoid splashing.

**Spill-Resistant Design:** Channels fluids away from internal components.

**Operating Conditions:**

Unit can be run in cold rooms, incubators, and CO<sub>2</sub> environments from 0 to 40°C (32 to 104°F), maximum 80% relative humidity, non-condensing.

**Applications:**

Blotting techniques, staining/destaining, and general shaking procedures.

**Ordering Information:**

Units include a 92" (234cm) detachable, 3-wire cord and plug (230 volt units are supplied with Euro type plug). Units are also supplied with an 11.75 x 8.75" (29.9 x 22.2cm) non-skid rubber mat. **5 year limited warranty on parts and labor.**



980173

Specifications	
Speed Range	40 to 300rpm
Orbit	15mm (0.6")
Maximum Weight Capacity	8lbs (3.6kg)
Tray Material	Aluminum
Tray Dimensions (L x W)	11.75 x 8.75" (29.9 x 22.2cm)
Overall Dimensions (L x W x H)	17 x 11 x 4" (43.2 x 27.9 x 10.2cm)
Ship Weight	25lbs (11.3kg)

Description	Electrical (50/60 Hz)	Part Number
Standard 1000 Orbital Shaker	120V   5.0 amps   25 watts	980173
Standard 1000 Orbital Shaker	230V   2.5 amps   25 watts	980174

## Advanced Touch 1000-3 Orbital Shaker

- Intuitive 4.3" color touch screen
- Programmable for 5 separate, 5-step programs
- Visibly track program progress through live status bar
- On-board help screens
- Built-in tray for mounting accessories
- Includes NIST traceable certificate for speed and time

The Talboys Advanced Touch 1000-3 Orbital Shaker is ideal for a wide variety of shaking applications that require consistent and precise results. Tray includes a non-skid rubber mat. Remove mat to mount a variety of optional flask clamps or test tube racks directly onto the tray.

### Operating Features:

**Low Profile Design:** The low profile design minimizes the unit's footprint on the bench and fits in most hoods and incubators.

**LCD Touch Screen:** Enables faster setting of speed and time which can be viewed at once. Display features on-screen help topics. Touch screen is compatible with rubber gloves used in labs.

**USB:** USB port can transfer data to a flash drive for data logging, program storage, and software updates.

**Program Control:** Program control capabilities allow user programmable operation for automated use and memory. Storage for five separate, 5-step programs, or unlimited number of programs with the use of the USB.

**Pulse Mode Feature:** The unit is equipped with a pulse mode feature ideal for quick mixing.

**Microprocessor Control:** The variable speed microprocessor control provides consistent uniform shaking action. Microprocessor will display last set-point and will restart if power is interrupted (continuous mode).

**Triple Eccentric Drive:** Permanently lubricated ball bearings and maintenance free, brushless DC motor provide reliable service and continuous duty operation.

### Safety Features:

**Overload Protection:** Audible and visual signals will activate when system detects an obstruction or overload of the tray.

**Speed Ramping Feature:** Slowly increases speed to desired set-point to avoid splashing.

**Audible Alarm:** In timed mode, alarm will sound when the time reaches zero.

**Spill-Resistant Design:** Channels fluids away from internal components.

### Operating Conditions:

Units can be run in cold rooms, incubators, and CO<sub>2</sub> environments from -10 to 60°C (14 to 140°F), maximum 80% relative humidity, non-condensing.

### Applications:

Cell, bacteria and fungi cultures, immunoassays, hybridization assays, and protein studies.



980TAOMNTSUSC

### Ordering Information

Units include a 92" (234cm) detachable, 3-wire cord and plug (230 volt units are supplied with Euro type plug). Units are also supplied with an 11.75 x 8.75" (29.9 x 22.2cm) non-skid rubber mat. **5 year limited warranty on parts and labor.**

**NIST Traceable Calibration Certificate** provided by Troemner's ISO/IEC 17025 accredited laboratory. Multiple data points within the speed range and time function are reported on the certificate with the associated uncertainties.

### Specifications

Speed Range	100 to 1200rpm
Speed Accuracy	+/-2%
Timer	1 minute to 99 hours, 59 minutes
Orbit	3mm (0.12")
Maximum Weight Capacity	8lbs (3.6kg)
Tray Material	Aluminum
Tray Dimensions (L x W)	11.75 x 8.75" (29.9 x 22.2cm)
Overall Dimensions (L x W x H)	17 x 11 x 4" (43.2 x 27.9 x 10.2cm)
Ship Weight	25lbs (11.3kg)

Description	Electrical (50/60 Hz)	Part Number
Advanced Touch 1000-3 Orbital Shaker with NIST Traceable Certificate	120V   0.3 amps   20 watts	980TAOMNTSUSC
Advanced Touch 1000-3 Orbital Shaker with NIST Traceable Certificate	230V   0.3 amps   20 watts	980TAOMNTSEUC

## Advanced 1000 Orbital Shakers



- General purpose shaker
- LED displays for speed and time
- 3mm or 15mm orbit

Talboys Advanced 1000-3 and 1000-15 Orbital Shakers are ideal for a wide variety of shaking applications. Tray includes a non-skid rubber mat. Remove the mat to mount a variety of optional flask clamps or test tube racks directly onto the tray.

**Operating Features:**

**Low Profile Design:** Takes up less space and easily fits into most hoods and incubators. Cast aluminum base offers durability and added stability.

**Microprocessor Control:** The variable speed microprocessor control provides consistent uniform shaking action. Microprocessor will display last set-point and will restart if power is interrupted.

**Triple Eccentric Drive:** Permanently lubricated ball bearings and maintenance free, brushless DC motor provide reliable service and continuous duty operation.

**LED Display:** Touch pad controls with easy-to-read, independent LED displays for speed and time allow operator to view both settings at once. Provides repeatable and accurate results every time and is easily visible across lab benches. Timer will display elapsed time or, when programmed to user defined limit, will shut off unit when time reaches zero. Display will show last used settings, even after power has been turned off.

**Safety Features:**

**Overload Protection:** Audible and visual signals will activate when system detects an obstruction or overload of the tray.

**Speed Ramping Feature:** Slowly increases speed to desired set-point to avoid splashing.

**Audible Alarm:** In timed mode, alarm will sound when the time reaches zero.

**Spill-Resistant Design:** Channels fluids away from internal components.

**Operating Conditions:**

Units can be run in cold rooms, incubators, and CO<sub>2</sub> environments.

Model 1000-3: -10 to 60°C (14 to 140°F)

Model 1000-15: -10 to 40°C (14 to 104°F)

Maximum 80% relative humidity, non-condensing.

**Applications:**

Cell cultures, immunoassays, and protein studies.

**Ordering Information**

Units include a 92" (234cm) detachable, 3-wire cord and plug (230 volt units are supplied with Euro type plug). Units are also supplied with an 11.75 x 8.75" (29.9 x 22.2cm) non-skid rubber mat. **5 year limited warranty on parts and labor.**



980175

**Optional NIST Traceable Calibration Certificate** provided by Troemner's ISO/IEC 17025 accredited laboratory. Multiple data points within the speed range and time function are reported on the certificate with the associated uncertainties.

Specifications	
Speed Range	
1000-3	100 to 1200rpm
1000-15	40 to 300rpm
Speed Accuracy	+/-2% above 100 rpm +/-2rpm below 100 rpm
Timer	1 second to 160 hours
Orbit	
1000-3	3mm (0.12")
1000-15	15mm (0.6")
Maximum Weight Capacity	8lbs (3.6kg)
Tray Material	Aluminum
Tray Dimensions (L x W)	11.75 x 8.75" (29.9 x 22.2cm)
Overall Dimensions (L x W x H)	17 x 11 x 4" (43.2 x 27.9 x 10.2cm)
Ship Weight	25lbs (11.3kg)

Description	Electrical (50/60 Hz)	Part Number
Advanced 1000-3 Orbital Shaker	120V   5.0 amps   25 watts	980175
Advanced 1000-3 Orbital Shaker	230V   5.0 amps   25 watts	980176
Advanced 1000-15 Orbital Shaker	120V   5.0 amps   25 watts	980398
Advanced 1000-15 Orbital Shaker	230V   5.0 amps   25 watts	980399
Advanced 1000-3 Orbital Shaker with NIST Traceable Certificate	120V   5.0 amps   25 watts	980175-C
Advanced 1000-3 Orbital Shaker with NIST Traceable Certificate	230V   5.0 amps   25 watts	980176-C
Advanced 1000-15 Orbital Shaker with NIST Traceable Certificate	120V   5.0 amps   25 watts	980398-C
Advanced 1000-15 Orbital Shaker with NIST Traceable Certificate	230V   5.0 amps   25 watts	980399-C

## Advanced Touch 1000MP Microplate Shaker

- Intuitive 4.3" color touch screen
- Programmable for 5 separate, 5-step programs
- Visibly track program progress through live status bar
- On-board help screens
- Accepts deep well plates, microplates or microtube racks
- Includes NIST traceable certificate for speed and time

The Talboys Advanced Touch 1000MP Microplate Shaker is ideal for immunoassays and general microplate shaking and is designed to be used in a variety of environmental conditions.

### Operating Features:

**Low Profile Design:** The low profile design minimizes the unit's footprint on the bench and fits in most hoods and incubators.

**LCD Touch Screen:** Enables faster setting of speed and time which can be viewed at once. Display features on-screen help topics. Touch screen is compatible with rubber gloves used in labs.

**USB:** USB port can transfer data to a flash drive for data logging, program storage, and software updates.

**Program Control:** Program control capabilities allow user programmable operation for automated use and memory. Storage for five separate, 5-step programs, or unlimited number of programs with the use of the USB.

**Pulse Mode Feature:** The unit is equipped with a pulse mode feature ideal for quick mixing.

**Microprocessor Control:** The variable speed microprocessor control provides consistent uniform shaking action. Microprocessor will display last set-point and will restart if power is interrupted (continuous mode).

**Triple Eccentric Drive:** Permanently lubricated ball bearings and maintenance free, brushless DC motor provide reliable service and continuous duty operation.

### Safety Features:

**Overload Protection:** Audible and visual signals will activate when system detects an obstruction or overload of the tray.

**Speed Ramping Feature:** Slowly increases speed to desired set-point to avoid splashing.

**Audible Alarm:** In timed mode, alarm will sound when the time reaches zero.

**Spill-Resistant Design:** Channels fluids away from internal components.

### Operating Conditions:

Units can be run in cold rooms, incubators, and CO<sub>2</sub> environments from -10 to 60°C (14 to 140°F), maximum 80% relative humidity, non-condensing.

### Applications:

ELISA assays, DNA studies, immunoassays, and magnetic bead applications.



980TAOMPTSUSC

### Ordering Information

Units include a 92" (234cm) detachable, 3-wire cord and plug (230 volt units are supplied with Euro type plug). **5 year limited warranty on parts and labor.**

**NIST Traceable Calibration Certificate** provided by Troemner's ISO/IEC 17025 accredited laboratory. Multiple data points within the speed range and time function are reported on the certificate with the associated uncertainties.

Specifications	
Speed Range	100 to 1200rpm
Speed Accuracy	± 2%
Timer	1 second to 160 hours
Orbit	3mm (0.12")
Maximum Weight Capacity	4 microplates or 2 micro-tube racks
Tray Material	Aluminum
Tray Dimensions (L x W)	11 x 7.75" (27.9 x 19.7cm)
Overall Dimensions (L x W x H)	17 x 11 x 4" (43.2 x 27.9 x 10.2cm)
Ship Weight	25lbs (11.3kg)

Description	Electrical (50/60 Hz)	Part Number
Advanced Touch 1000MP Microplate Shaker with NIST Traceable Certificate	120V   0.3 amps   20 watts	980TAOMPTSUSC
Advanced Touch 1000MP Microplate Shaker with NIST Traceable Certificate	230V   0.3 amps   20 watts	980TAOMPTSEUC

## Advanced 1000 MP Microplate Shaker



- Holds up to 4 microplates or 2 micro-tube racks
- Accepts deep well plates
- Timer with audible alarm

The Talboys Advanced 1000MP Microplate Shaker is ideal for immunoassays and general microplate shaking, and is designed to be used in a variety of environmental conditions.

### Operating Features:

**Low Profile Design:** Takes up less space and easily fits into most hoods and incubators. Cast aluminum base offers durability and added stability.

**Microprocessor Control:** The variable speed microprocessor control provides consistent uniform shaking action. Microprocessor will display last set-point and will restart if power is interrupted.

**Triple Eccentric Drive:** Permanently lubricated ball bearings and maintenance free, brushless DC motor provide reliable service and continuous duty operation.

**LED Display:** Touch pad controls with easy-to-read, independent LED displays for speed and time allow operator to view all settings at once. Provides repeatable and accurate results every time and is easily visible across lab benches. Timer will display elapsed time or, when programmed to user defined limit, will shut off unit when time reaches zero. Display will show last used settings, even after power has been turned off.

### Safety Features:

**Overload Protection:** Audible and visual signals will activate when system detects an obstruction or overload of the tray.

**Speed Ramping Feature:** Slowly increases speed to desired set-point to avoid splashing.

**Audible Alarm:** In timed mode, alarm will sound when the time reaches zero.

**Spill-Resistant Design:** Channels fluids away from internal components.

### Operating Conditions:

Unit can be run in cold rooms, incubators, and CO<sub>2</sub> environments from -10 to 60°C (14 to 140°F), maximum 80% relative humidity, non-condensing.

### Applications:

ELISA assays and DNA studies.

### Ordering Information:

Units include a 92" (234cm) detachable, 3-wire cord and plug (230 volt units are supplied with Euro type plug). **5 year limited warranty on parts and labor.**

**Optional NIST Traceable Calibration Certificate** provided by Troemner's ISO/IEC 17025 accredited laboratory. Multiple data points within the speed range and time function are reported on the certificate with the associated uncertainties.



980178

Specifications	
Speed Range	100 to 1200rpm
Speed Accuracy	± 2%
Timer	1 second to 160 hours
Orbit	3mm (0.12")
Maximum Weight Capacity	4 microplates or 2 micro-tube racks
Tray Material	Aluminum
Tray Dimensions (L x W)	11 x 7.75" (27.9 x 19.7cm)
Overall Dimensions (L x W x H)	17 x 11 x 4" (43.2 x 27.9 x 10.2cm)
Ship Weight	25lbs (11.3kg)

Description	Electrical (50/60 Hz)	Part Number
Advanced 1000MP Microplate Shaker	120V   5.0 amps   25 watts	980178
Advanced 1000MP Microplate Shaker	230V   5.0 amps   25 watts	980179
Advanced 1000MP Microplate Shaker with NIST Traceable Certificate	120V   5.0 amps   25 watts	980178-C
Advanced 1000MP Microplate Shaker with NIST Traceable Certificate	230V   5.0 amps   25 watts	980179-C

## Advanced High Speed Microplate Shaker

- Programable pulse feature
- Shakes traditional or deep-well microplates
- Shakes up to 48 microplates at one time

The Talboys Advanced High Speed Microplate Shakers handle shaking for difficult applications. These units operate at up to 2500rpm while holding deep-well blocks and small diameter test tubes no taller than 5" (12.7cm).

Advanced High Speed Microplate Shakers have variable speed control from 600 to 2500rpm.

### Operating Features:

**LED Display:** Touch pad controls with easy-to-read, independent LED displays for speed and time allow operator to view both settings at once. Provides repeatable and accurate results every time and is easily visible across lab benches. Timer will display elapsed time or, when programmed to user defined limit, will shut off unit when time reaches zero. Display will show last used settings, even after power has been turned off.

**Programmable "Pulsing" Feature:** Enhances shaking action and allows user to program the unit to stop and start in a wide range of intervals.

**RS-232 interface:** Provides two-way communication for data logging and unit control

### Operating Conditions:

Unit can be run in cold rooms and incubators from 4 to 40°C (39 to 104°F), 20 to 80% relative humidity, non-condensing.

### Applications:

Emulsifications and cell lysing.

### Ordering Information:

Units include a 92" (234cm) detachable, 3-wire cord and plug (230 volt units are supplied with Euro type plug). **5 year limited warranty on parts and labor.**

**Optional NIST Traceable Calibration Certificate** provided by Troemner's ISO/IEC 17025 accredited laboratory. Multiple data points within the speed range and time function are reported on the certificate with the associated uncertainties.



945170

### Specifications

Speed Range	600 to 2500rpm
Timer	1 second to 160 hours
Orbit	3.6mm (0.14")
Maximum Weight Capacity	48 microplates or up to 7lbs (3.2kg)
Tray Material	Aluminum
Tray Dimensions (L x W)	12.25 x 11" (31.1 x 27.9cm)
Overall Dimensions (L x W x H)	15.5 x 12 x 12.8" (39.4 x 30.5 x 32.5cm)
Ship Weight	50lbs (22.7kg)

Description	Electrical (50/60 Hz)	Part Number
Advanced High Speed Microplate Shaker	120V   1.0 amp   120 watts	945170
Advanced High Speed Microplate Shaker	230V   1.0 amp   120 watts	945175
Advanced High Speed Microplate Shaker with NIST Traceable Certificate	120V   1.0 amp   120 watts	945170-C
Advanced High Speed Microplate Shaker with NIST Traceable Certificate	230V   1.0 amp   120 watts	945175-C



## Standard Analog 1000RS Rocking Shaker



- Variable control for speed, tilt and time
- 16 lb capacity
- Two-tier model doubles workable capacity

The Talboys Analog Rocking Shaker is an easy and economical option for all of your rocking needs. The Rocking Shaker is ideal for cell culture and blotting applications and is designed to be used in a variety of environmental conditions. Rocker is supplied with an 14 x 11" (35.6 x 27.9cm) non-skid rubber mat.

### Operating Features:

**Low Profile Design:** Takes up less bench space and fits into most hoods and incubators. Two-tier option increases the capacity with the same footprint and provides a 3.5" (8.9cm) clearance between platforms. Cast aluminum base offers durability and added stability

**Microprocessor Control:** The microprocessor control provides tilt adjustment which allows user to easily adjust rocking angle from 0 to 15° while unit is operating. Smooth speed control with low speed rocking motion.

**Independent Control Knobs:** Independent control knobs for speed, tilt, and time, allow for easy adjustments.

### Safety Features:

**Overload Protection:** Audible signal will activate when system detects an obstruction or overload of the tray.

**Speed Ramping Feature:** Slowly increases speed to desired set-point to avoid splashing.

**Timer:** Timer will automatically stop rocking motion when timer reaches zero.

**Spill-Resistant Design:** Channels fluids away from internal components.

### Operating Conditions:

Unit can be run in cold rooms, incubators, and CO<sub>2</sub> environments from -10 to 60°C (14 to 140°F), maximum 80% relative humidity, non-condensing.

### Applications:

Staining and destaining gels, hybridization procedures, hematology, and blotting techniques.

### Ordering Information:

Units include a 92" (234cm) detachable, 3-wire cord and plug (230V units are supplied with a Euro type plug). Units are also supplied with a 14 x 11" (35.6 x 27.9cm) non-skid rubber mat. Two-tier models include a 2nd tray, non-skid mat and hardware.



Specifications	
Speed Range	1 to 75rpm*
Tilt Angle	0 to 15°*
Timer	1 minute to 120 minutes
Maximum Weight Capacity	16lbs (7.3kg)**
Tray Material	Aluminum
Tray Dimensions (L x W)	14 x 11" (35.6 x 27.9cm)
Overall Dimensions (L x W x H)	1 Tier 17 x 11 x 5" (43.2 x 27.9 x 12.7cm)
	2 Tier 17 x 11 x 9" (43.2 x 27.9 x 22.9cm)
Ship Weight	15.5lbs (7kg)

\* Maximum speed/tilt angle may vary with heavy or unbalanced loads.

\*\* Centered on tray.

Description	Electrical (50/60 Hz)	Part Number
Standard 1000RS One Tier Rocking Shaker	120V   0.125 amps   15 watts	980TAOARATUS
Standard 1000RS One Tier Rocking Shaker	230V   0.065 amps   15 watts	980TAOARA1EU
Standard 1000RS Two Tier Rocking Shaker	120V   0.125 amps   15 watts	980TAOARA2US
Standard 1000RS Two Tier Rocking Shaker	230V   0.065 amps   15 watts	980TAOARA2EU

- Intuitive 4.3" color touch screen
- Programmable for 5 separate, 5-step programs
- Visibly track program progress through live status bar
- On-board help screens
- Electronic tilt adjustments from 0 to 15° while unit is operating
- Includes NIST traceable certificate for speed and time

The Talboys Advanced Touch 1000RS Rocking Shakers are ideal for cell culture work offering a smooth rocking motion and is designed to be used in a variety of environmental conditions.

### Operating Features:

**Low Profile Design:** The low profile design minimizes the unit's footprint on the bench.

**LCD Touch Screen:** Enables faster setting of speed, tilt angle and time which can be viewed at once. Display features on-screen help topics. Touch screen is compatible with rubber gloves used in labs.

**USB:** USB port can transfer data to a flash drive for data logging, program storage, and software updates.

**Program Control:** Program control capabilities allow user programmable operation for automated use and memory. Storage for five separate, 5-step programs, or unlimited number of programs with the use of the USB.

**Pulse Mode Feature:** The unit is equipped with a pulse mode feature ideal for quick rocking.

**Microprocessor Control:** The variable speed microprocessor control provides electronic tilt angle and speed adjustments which allows user to easily adjust rocking angle and speed while unit is operating. Precise speed and tilt angle control provides smooth, low speed rocking motion down to 1rpm. Microprocessor will display last set-point and will restart if power is interrupted (continuous mode).

### Safety Features:

**Overload Protection:** Audible and visual signals will activate when system detects an obstruction or overload of the tray.

**Speed Ramping Feature:** Slowly increases speed to desired set-point to avoid splashing.

**Audible Alarm:** In timed mode, alarm will sound when the time reaches zero.

**Spill-Resistant Design:** Channels fluids away from internal components.

### Operating Conditions:

Units can be run in cold rooms, incubators, and CO<sub>2</sub> environments from -10 to 60°C (14 to 140°F), maximum 80% relative humidity, non-condensing.

### Applications:



980TAOARTSUSC

Cell cultures, hematology, staining and destaining gels, hybridizations, and blotting techniques.

### Ordering Information

Units include a 92" (234cm) detachable, 3-wire cord and plug (230 volt units are supplied with Euro type plug). Units are also supplied with a 12.75 x 10" (32.4 x 25.4cm) non-skid rubber mat. **5 year limited warranty on parts and labor.**

**NIST Traceable Calibration Certificate** provided by Troemner's ISO/IEC 17025 accredited laboratory. Multiple data points within the speed's range and time function are reported on the certificate with the associated uncertainties.

### Specifications

Speed Range	1 to 50rpm*
Speed Accuracy	± 1rpm
Tilt Angle	0 to 15° *
Timer	1 minute to 99 hours, 59 minutes
Maximum Weight Capacity	10lbs (4.5kg)**
Tray Material	Aluminum
Tray Dimensions (L x W)	12.75 x 10" (32.4 x 25.4cm)
Overall Dimensions (L x W x H)	17 x 11 x 6" (43.2 x 27.9 x 12.7cm)
Ship Weight	15.5lbs (7kg)

\* Maximum speed/tilt angle may vary with heavy or unbalanced loads.

\*\* Centered on tray.

Description	Electrical (50/60 Hz)	Part Number
Advanced Touch 1000RS Rocking Shaker with NIST Traceable Certificate	120V   0.3 amps   22 watts	980TAOARTSUSC
Advanced Touch 1000RS Rocking Shaker with NIST Traceable Certificate	230V   0.3 amps   20 watts	980TAOARTSEUC

## Advanced 1000RS Rocking Shaker



- Electronic tilt adjustment from 0 to 15° while unit is operating
- Displays for speed, tilt angle and time
- Timer with audible alarm

The Talboys Advanced 1000RS Rocking Shaker is ideal for cell culture work and is designed to be used in a variety of environmental conditions.

### Operating Features:

**Low Profile Design:** Takes up less space and easily fits into most hoods and incubators. Cast aluminum base offers durability and added stability.

**Microprocessor Control:** The microprocessor control provides electronic tilt angle adjustment which allows user to easily adjust rocking angle from 0 to 15° while unit is operating. Precise speed control provides smooth, low-speed rocking motion down to 1rpm.

**LED Display:** Touch pad controls with easy-to-read, independent LED displays for speed and tilt angle, and time allow operator to view all settings at once. Provides repeatable and accurate results every time and is easily visible across lab benches. Timer will display elapsed time or, when programmed to user defined limit, will shut off unit when time reaches zero. Display will show last used settings, even after power has been turned off.

### Safety Features:

**Overload Protection:** Audible and visual signals will activate when system detects an obstruction or overload of the tray.

**Speed Ramping Feature:** Slowly increases speed to desired set-point to avoid splashing.

**Audible Alarm:** In timed mode, alarm will sound when the time reaches zero.

**Spill-Resistant Design:** Channels fluids away from internal components.

### Operating Conditions:

Unit can be run in cold rooms, incubators, and CO<sub>2</sub> environments from -10 to 60°C (14 to 140°F), maximum 80% relative humidity, non-condensing.

### Applications:

Staining and destaining gels, hybridization procedures, hematology, and blotting techniques.

### Ordering Information:

Units include a 92" (234cm) detachable, 3-wire cord and plug (230 volt units are supplied with Euro type plug). Units are also supplied with a 12.75 x 10" (32.4 x 25.4cm) non-skid rubber mat. **5 year limited warranty on parts and labor.**

**Optional NIST Traceable Calibration Certificate** provided by Troemner's ISO/IEC 17025 accredited laboratory. Multiple data points within the speed range and time function are reported on the certificate with the associated uncertainties.



980530

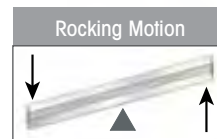

### Specifications

Speed Range	1 to 50rpm*
Speed Accuracy	± 1rpm
Tilt Angle	0 to 15°*
Timer	1 second to 160 hours
Maximum Weight Capacity	10lbs (4.5kg)**
Tray Material	Aluminum
Tray Dimensions (L x W)	12.75 x 10" (32.4 x 25.4cm)
Overall Dimensions (L x W x H)	17 x 11 x 5" (43.2 x 27.9 x 12.7cm)
Ship Weight	15.5lbs (7kg)

\* Maximum speed/tilt angle may vary with heavy or unbalanced loads.

\*\* Centered on tray.

### Description

Advanced 1000RS Rocking Shaker

Advanced 1000RS Rocking Shaker

Advanced 1000RS Rocking Shaker with NIST Traceable Certificate

Advanced 1000RS Rocking Shaker with NIST Traceable Certificate

### Electrical (50/60 Hz)

120V | 5.0 amps | 25 watts

230V | 5.0 amps | 25 watts

120V | 5.0 amps | 25 watts

230V | 5.0 amps | 25 watts

### Part Number

980530

980531

980530-C

980531-C

## Standard Analog 1000WS Waving Shaker

- Variable control for speed, tilt and time
- 5lb capacity
- 5 year warranty on parts and labor

The Talboys Analog Waving Platform Shakers are an easy and economical option for all of your waving needs. Ideal for cell culture and blotting applications, and is designed to be used in a variety of environmental conditions.

### Operating Features:

**Low Profile Design:** Takes up less space and easily fits into most hoods and incubators. Cast aluminum base offers durability and added stability.

**Microprocessor Control:** Provides tilt adjustment which allows user to easily adjust waving angle from 0 to 16° while unit is operating. Smooth speed control with low speed waving motion.

**Independent Control Knobs:** Independent control knobs for speed, tilt and time allow for easy adjustments.

### Safety Features:

**Overload Protection:** Audible and visual signals will activate when system detects an obstruction or overload of the tray.

**Speed Ramping Feature:** Slowly increases speed to desired set-point to avoid splashing.

**Timer:** Timer, if engaged, will automatically stop waving motion when timer reaches zero.

**Spill-Resistant Design:** Channels fluids away from internal components.

### Operating Conditions:

Unit can be run in cold rooms, incubators, and CO<sub>2</sub> environments from -10 to 60°C (14 to 140°F), maximum 80% relative humidity, non-condensing.

### Applications:

Staining and destaining gels, hybridization procedures, hematology, and blotting techniques.

### Ordering Information:

Units include a 92" (234cm) detachable, 3-wire cord and plug (230 volt units are supplied with Euro type plug). Units are also supplied with a 14 x 11" (35.6 x 27.9 cm) non-skid rubber mat. **5 year limited warranty on parts and labor.**



980TAOAWTSUS

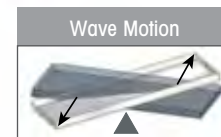

### Specifications

Speed Range	1 to 75rpm*
Tilt Angle	0 to 16°*
Timer	1 minute to 120 minutes
Maximum Weight Capacity	5lbs (2.3kg)**
Tray Material	Aluminum
Tray Dimensions (L x W)	14 x 11" (35.6 x 27.9cm)
Overall Dimensions (L x W x H)	17 x 11 x 6" (43.2 x 27.9 x 15.2cm)
Ship Weight	15.5lbs (7kg)

\* Maximum speed/tilt angle may vary with heavy or unbalanced loads.

\*\* Centered on tray.

Description	Electrical (50/60 Hz)	Part Number
Standard 1000WS Waving Shaker	120V   0.125 amps   15 watts	980TAOAWTSUS
Standard 1000WS Waving Shaker	230V   0.065 amps   15 watts	980TAOAWTSEU

## Advanced Touch 1000WS Waving Shaker



- Intuitive 4.3" color touch screen
- Programmable to rotate clockwise or counter-clockwise
- Programmable for 5 separate, 5-step programs
- Visibly track program progress through live status bar
- On-board help screens
- Electronic tilt adjustments from 0 to 20° while unit is operating
- Includes NIST traceable certificate for speed and time

The Talboys Advanced Touch 1000WS Waving Shaker is ideal for cell culture work and is designed to be used in a variety of environmental conditions.

**Operating Features:**

**Low Profile Design:** The low profile design minimizes the unit's footprint on the bench.

**LCD Touch Screen:** Enables faster setting of speed, tilt angle and time which can be viewed at once. Display features on-screen help topics. Touch screen is compatible with rubber gloves used in labs.

**USB:** USB port can transfer data to a flash drive for data logging, program storage, and software updates.

**Program Control:** Program control capabilities allow user programmable operation for automated use and memory. Storage for five separate, 5-step programs, or unlimited number of programs with the use of the USB. Unit can be programmed to wave in a clockwise, counter-clockwise or both motions within a program, for the most thorough mixing.

**Pulse Mode Feature:** The unit is equipped with a pulse mode feature ideal for quick waving.

**Microprocessor Control:** The variable speed microprocessor control provides electronic tilt angle and speed adjustments which allows user to easily adjust waving angle and speed while unit is operating. Precise speed and tilt angle control provides smooth, low speed waving motion down to 1rpm. Microprocessor will display last set-point and will restart if power is interrupted (continuous mode).

**Safety Features:**

**Overload Protection:** Audible and visual signals will activate when system detects an obstruction or overload of the tray.

**Speed Ramping Feature:** Slowly increases speed to desired set-point to avoid splashing.

**Audible Alarm:** In timed mode, alarm will sound when the time reaches zero.

**Spill-Resistant Design:** Channels fluids away from internal components.

**Operating Conditions:**

Units can be run in cold rooms, incubators, and CO<sub>2</sub> environments from -10 to 60°C (14 to 140°F), maximum 80% relative humidity, non-condensing.

**Applications:**

Staining and destaining gels, DNA extractions, blotting techniques, and general mixing of various size tubes.



980TAOAWTSUSC

**Ordering Information**

Units include a 92" (234cm) detachable, 3-wire cord and plug (230 volt units are supplied with Euro type plug). Units are also supplied with an 11.75 x 8.75" (29.9 x 22.2cm) non-skid rubber mat. **5 year limited warranty on parts and labor.**

**NIST Traceable Calibration Certificate** provided by Troemner's ISO/IEC 17025 accredited laboratory. Multiple data points within the speed range and time function are reported on the certificate with the associated uncertainties.

**Specifications**

Speed Range	1 to 30rpm*
Speed Accuracy	± 1rpm
Tilt Angle	0 to 20°*
Timer	1 minute to 99 hours, 59 minutes
Maximum Weight Capacity	10lbs (4.5kg)**
Tray Material	Aluminum
Tray Dimensions (L x W)	11.75 x 8.75" (29.9 x 22.2cm)
Overall Dimensions (L x W x H)	17 x 11 x 6" (43.2 x 27.9 x 15.2cm)
Ship Weight	16lbs (7.3kg)

\* Maximum speed/tilt angle may vary with heavy or unbalanced loads.

\*\* Centered on tray.

Description	Electrical (50/60 Hz)	Part Number
Advanced Touch 1000WS Waving Shaker with NIST Traceable Certificate	120V   0.3 amps   22 watts	980TAOAWTSUSC
Advanced Touch 1000WS Waving Shaker with NIST Traceable Certificate	230V   0.3 amps   20 watts	980TAOAWTSEUC

## Advanced 1000WS Waving Shaker

- Electronic tilt adjustment from 0 to 20° while unit is operating
- Displays for speed and tilt angle, and time
- Timer with audible alarm

The Talboys Advanced 1000WS Waving Shaker provides precise speed control and a smooth, low foaming, three dimensional, "wave" motion. Ideal for use in a wide range of laboratory applications and designed to be used in a variety of environmental conditions. Tray includes a non-skid rubber mat that is suitable for holding Petri dishes.

### Operating Features:

**Low Profile Design:** Takes up less space and easily fits into most hoods and incubators. Cast aluminum base offers durability and added stability.

**Microprocessor Control:** The microprocessor control provides electronic tilt angle adjustment which allows user to easily adjust waving angle from 0 to 20° while unit is operating. Precise speed control provides smooth, low-speed waving motion down to 1rpm.

**LED Display:** Touch pad controls with easy-to-read, independent LED displays for speed and tilt angle, and time allow operator to view all settings at once. Provides repeatable and accurate results every time and is easily visible across lab benches. Timer will display elapsed time or, when programmed to user defined limit, will shut off unit when time reaches zero. Display will show last settings, even after power has been turned off.

### Safety Features:

**Overload Protection:** Audible and visual signals will activate when system detects an obstruction or overload of the tray.

**Speed Ramping Feature:** Slowly increases speed to desired set-point to avoid splashing.

**Audible Alarm:** In timed mode, alarm will sound when the time reaches zero.

**Spill-Resistant Design:** Channels fluids away from internal components.

### Operating Conditions:

Unit can be run in cold rooms, incubators, and CO<sub>2</sub> environments from -10 to 60°C (14 to 140°F), maximum 80% relative humidity, non-condensing.

### Applications:

Blood samples, DNA extractions, blotting techniques, and general mixing of various size tubes.

### Ordering Information:

Units include a 92" (234cm) detachable, 3-wire cord and plug (230 volt units are supplied with Euro type plug). Units are also supplied with an 11.75 x 8.75" (29.9 x 22.2 cm) non-skid rubber mat. **5 year limited warranty on parts and labor.**

**Optional NIST Traceable Calibration Certificate** provided by Troemner's ISO/IEC 17025 accredited laboratory. Multiple data points within the speed range and time function are reported on the certificate with the associated uncertainties.



980537

Specifications	
Speed Range	1 to 30rpm*
Speed Accuracy	± 1rpm
Tilt Angle	0 to 20°*
Timer	1 second to 160 hours
Maximum Weight Capacity	5lbs (2.3kg)**
Tray Material	Aluminum
Tray Dimensions (L x W)	11.75 x 8.75" (29.9 x 22.2cm)
Overall Dimensions (L x W x H)	17 x 11 x 6" (43.2 x 27.9 x 15.2cm)
Ship Weight	16lbs (7.3kg)

\* Maximum speed/tilt angle may vary with heavy or unbalanced loads.

\*\* Centered on tray.

Description	Electrical (50/60 Hz)	Part Number
Advanced 1000WS Waving Shaker	120V   5.0 amps   25 watts	980537
Advanced 1000WS Waving Shaker	230V   5.0 amps   25 watts	980538
Advanced 1000WS Waving Shaker with NIST Traceable Certificate	120V   5.0 amps   25 watts	980537-C
Advanced 1000WS Waving Shaker with NIST Traceable Certificate	230V   5.0 amps   25 watts	980538-C



## Incubating Shaker Selection Guide



Thermal Shake Touch and Cooling Thermal Shake Touch



Professional 5000I Incubating Orbital Shaker



Professional 5000IR Incubating/Refrigerating Orbital Shaker



Professional 3500 Incubating Orbital Shaker

	Thermal Shake Touch and Cooling Thermal Shake Touch	Professional 5000I Incubating Orbital Shaker	Professional 5000IR Incubating/Refrigerating Orbital Shaker	Professional 3500 Incubating Orbital Shaker
<b>Temperature Range</b>	See Page 36	Ambient +5° to 65°C	15°C Below Ambient to 65°C	Ambient +5° to 65°C
<b>Speed Range</b>	300 to 3000rpm	15 to 500rpm	15 to 500rpm	15 to 500rpm
<b>Timer</b>	1 minute to 99 hour, 59 min.	1 second to 160 hours	1 second to 160 hours	1 second to 160 hours
<b>Motion</b>	Orbital	Orbital	Orbital	Orbital
<b>Orbit</b>	3mm	25.4mm	25.4mm	19mm
<b>Max Weight Capacity</b>	17lbs	50lbs	50lbs	35lbs
<b>Audible Alarm</b>	●	●	●	●
<b>Load Sensor</b>	-	●	●	-
<b>Drive System</b>	Single Eccentric	Triple Eccentric	Triple Eccentric	Triple Eccentric
<b>Motor Type</b>	Brushless DC Motor	Brushless DC Motor	Brushless DC Motor	Brushless DC Motor
<b>Set-Point Retention</b>	Yes/Displays Last Setting	Yes/Displays Last Setting	Yes/Displays Last Setting	Yes/Displays Last Setting
<b>Restart/Power Out</b>	●	●	●	●
<b>Ramp to Speed</b>	●	●	●	●
<b>Temperature Overshoot Protection</b>	●	●	●	●
<b>Overload Protection</b>	-	●	●	●
<b>User Calibration (Temperature)</b>	●	●	●	●
<b>User Calibration (Speed)</b>	-	●	●	-
<b>RS-232 Interface</b>	USB Port	●	●	-
<b>Overall Dimensions</b>	10.25 x 9.75 x 5.2"	32.1 x 26.6 x 23.5"	41.1 x 26.6 x 23.5"	25.5 x 14 x 16"
<b>Included Tray (L x W)</b>	1.5mL Block	18 x 18"	18 x 18"	13 x 11"
<b>Platform Options (L x W)</b>	-	18 x 18"	18 x 18"	13 x 11"

● Yes



Incubating Shaker Selection Guide



Professional 1000-3  
Incubating Orbital Shaker



Professional 1000MP  
Incubating Microplate Shaker



Professional 1000IC-3  
Incubating/Cooling  
Orbital Shaker



Professional 1000RS  
Incubating Rocking Shaker



Professional 1000WS  
Incubating Waving Shaker

<p>Ambient +5° to 65°C</p> <p>100 to 1200rpm</p> <p>1 second to 160 hours</p> <p>Orbital</p> <p>3mm</p> <p>8lbs</p> <p>●</p> <p>-</p> <p>Triple Excentric</p> <p>Brushless DC Motor</p> <p>Yes/Displays Last Setting</p> <p>●</p> <p>●</p> <p>-</p> <p>●</p> <p>●</p> <p>-</p> <p>-</p> <p>17 x 11 x 10.5"</p> <p>11 x 7.75"</p> <p>N/A</p>	<p>Ambient +5° to 65°C</p> <p>100 to 1200rpm</p> <p>1 second to 160 hours</p> <p>Orbital</p> <p>3mm</p> <p>4 Microplates / 2 Micro-Tube Rackss</p> <p>●</p> <p>-</p> <p>Triple Eccentric</p> <p>Brushless DC Motor</p> <p>Yes/Displays Last Setting</p> <p>●</p> <p>●</p> <p>-</p> <p>●</p> <p>●</p> <p>-</p> <p>-</p> <p>17 x 11 x 7.75"</p> <p>11 x 7.75"</p> <p>N/A</p>	<p>10°C Below Ambient to 65°C</p> <p>100 to 1200rpm</p> <p>1 second to 160 hours</p> <p>Orbital</p> <p>3mm</p> <p>2 Microplates / 2 Modular Blocks</p> <p>●</p> <p>-</p> <p>Triple Eccentric</p> <p>Brushless DC Motor</p> <p>Yes/Displays Last Setting</p> <p>●</p> <p>●</p> <p>-</p> <p>●</p> <p>-</p> <p>-</p> <p>17.9 x 11 x 10.5"</p> <p>N/A</p> <p>N/A</p>	<p>Ambient +5° to 65°C</p> <p>1 to 50rpm</p> <p>1 second to 160 hours</p> <p>Rocking</p> <p>Tilt Angle: 0 to 15° *</p> <p>10lbs**</p> <p>●</p> <p>-</p> <p>Cable</p> <p>Stepper Motor</p> <p>Yes/Displays Last Setting</p> <p>●</p> <p>●</p> <p>-</p> <p>●</p> <p>-</p> <p>-</p> <p>17 x 11 x 10.5"</p> <p>10 x 7.5"</p> <p>N/A</p>	<p>Ambient +5° to 65°C</p> <p>1 to 30rpm</p> <p>1 second to 160 hours</p> <p>Waving</p> <p>Tilt Angle: 0 to 20° *</p> <p>5lbs**</p> <p>-</p> <p>-</p> <p>Cable</p> <p>Stepper Motor</p> <p>Yes/Displays Last Setting</p> <p>-</p> <p>-</p> <p>-</p> <p>-</p> <p>17 x 11 x 10.5"</p> <p>9.25 x 7.25"</p> <p>N/A</p>
---	--	--	---	--

● Yes

\* Maximum speed/tilt angle may vary with heavy or unbalanced loads.

\*\* Centered on tray.

- 4.3" color LCD touch screen display provides an intuitive interface
- Rapid heating, cooling and high speed shaking ability
- Internal memory stores five separate 5-step programs, unlimited with USB

The Talboys Thermal Shake Touch and Cooling Thermal Shake Touch are designed for applications that require consistent and precise results. With heating, cooling and shaking capabilities. The Thermal Shake Touch and Cooling Thermal Shake Touch uses interchangeable blocks to accommodate a wide variety of tubes and microplates. The easy-to-use, 4.3", color, LCD touch screen allows the user to save and visibly track progress through the live status bar for five user defined programs, each with five individual steps. The unit's enhanced electronics and dual temperature sensors provide accurate, dependable temperature settings across the operating range.

### Operating Features:

**Low Profile Design:** The low profile design minimizes the unit's footprint on the bench.

**LCD Touch Screen:** Enables faster setting of temperature, speed, and time which can all be viewed at once. Display features on-screen help topics with operational tips available in six languages. Touch screen is compatible with rubber gloves used in labs. USB port can transfer information to a flash drive for data logging, program storage and software updates.

**Program Control:** Program control capabilities allow user programmable operation for automated use and memory. Storage for five separate 5-step programs, or unlimited number of programs with the use of the USB.

**Temperature ramp rate:** Adjustable temperature ramp rate feature separately defines the heating and cooling rate in increments of 0.5°C/min.

**Single Point Calibration Mode:** For maximum temperature accuracy, the single point calibration procedure allows the user to calibrate up to 6 different user defined temperatures.

**Pulse Mode Feature:** The unit is equipped with a pulse mode feature for quick vortex applications.

### Safety Features:

**Cool Touch Housing:** Constructed from a high-quality, heat and chemical resistant polymer. The unit's housing remains cool to the touch throughout normal operating temperatures.

**Maximum Temperature Limiting Function:** Ensures the temperature will not exceed preset limits, allowing the user control of temperature sensitive samples.

**Hot Top Indicator:** A hot top warning light will illuminate when the temperature reaches 40°C, and will remain lit until the unit is sufficiently cooled.

**Audible Alarm:** In timed mode, an alarm will sound when the time reaches zero or set-point temperature is reached. Additionally, the heat function will automatically shut off if the unit recognizes an internal issue.

### Operating Conditions:

Unit can operate in conditions from 5 to 35°C (41 to 95°F), maximum 80% relative humidity, non-condensing.

### Applications:

Cell cultures, DNA, RNA, and protein studies.



980TAHSCTSUS

### Ordering Information

Unit includes a 92" (234cm) detachable, 3-wire cord and plug (230 volt units are supplied with Euro type plug). Unit is also supplied with a 1.5mL block, clear rack, and cover. **5 year limited warranty on parts and labor.**

**Optional NIST Traceable Calibration Certificate** provided by Troemner's ISO/IEC 17025 accredited laboratory. Multiple data points within the temperature and speed ranges, and time function, are reported on the certificate with the associated uncertainties.

### Specifications

Temperature Range	
Thermal Shake Touch	4°C above ambient to 100°C
Cooling Thermal Shake Touch	17°C below ambient to 100°C
Temperature Accuracy	
Thermal Shake Touch	± 1°C between 20°C and 45°C ± 2°C above 45°C
Cooling Thermal Shake Touch	± 0.5°C between 20°C and 45°C ± 2°C below 20°C and above 45°C
Speed Range	300 to 3000rpm
Speed Accuracy	± 2%
Timer	1 minute to 99 hours, 59 minutes
Orbit	3mm (0.12")
Cooling Rate	Above ambient 2-3°C/min Below ambient 0.5-1.0°C/min
Heating Rate	5°C/min
Overall Dimensions (L x W x H)	10.25 x 9.75 x 5.2" (26 x 24.8 x 13.2cm)
Ship Weight	11.9lbs (5.4kg)

Description	Electrical (50/60 Hz)	Part Number
Thermal Shake Touch	120V   1.8 amps   215 watts	980TAHTSTSUS
Thermal Shake Touch	230V   0.9 amps   210 watts	980TAHTSTSEU
Cooling Thermal Shake Touch	120V   1.8 amps   215 watts	980TAHSCTSUS
Cooling Thermal Shake Touch	230V   0.9 amps   210 watts	980TAHSCTSEU
Thermal Shake Touch with NIST Traceable Certificate	120V   1.8 amps   215 watts	980TAHTSTSUC
Thermal Shake Touch with NIST Traceable Certificate	230V   0.9 amps   210 watts	980TAHTSTSEC
Cooling Thermal Shake Touch with NIST Traceable Certificate	120V   1.8 amps   215 watts	980TAHSCTSUC
Cooling Thermal Shake Touch with NIST Traceable Certificate	230V   0.9 amps   210 watts	980TAHSCTSEC

## Thermal Shake Touch Modular Blocks



## Microplate Block

Sample Type	Well Size	Well Depth	Dimensions (L x W x H)	Part Number
Microplate Thermal Block with Lid	4.21 x 2.81 x 0.1" (10.7 x 7.1 x 0.25cm)	0.9" (2.3cm)	4.7 x 6.4 x 3.0" (11.9 x 16.3 x 7.6cm)	980TAMCPLT

Sample Type	Well Diameter	Well Depth	Dimensions (L x W x H)	Part Number
384 Well Plate Thermal Block with Lid	0.16" (0.4cm)	0.32" (0.81cm)	4.7 x 6.4 x 3.0" (11.9 x 16.3 x 7.6cm)	980TA384PLT
0.2mL PCR Plate Thermal Block with Lid	0.25" (0.64cm)	0.50" (1.27cm)	4.7 x 6.4 x 3.0" (11.9 x 16.3 x 7.6cm)	980TAMTB02

## Tube Blocks

Sample Type	No. of Wells	Well Diameter	Well Depth	Dimensions (L x W x H)	Part Number
0.5mL Microtubes*	30	0.31" (0.79cm)	0.97" (2.46cm)	4.0 x 5.6 x 1.8" (10.2 x 14.2 x 4.6cm)	980TAMTB05
1.5mL Microtubes*	24	0.44" (1.11cm)	1.39" (3.53cm)	4.0 x 5.6 x 2.1" (10.2 x 14.2 x 5.3cm)	980TAMTB15
2.0mL Microtubes*	24	0.45" (1.15cm)	1.39" (3.53cm)	4.0 x 5.6 x 2.1" (10.2 x 14.2 x 5.3cm)	980TAMTB20
5-7mL Tubes	24	0.47" (1.20cm)	1.42" (3.61cm)	4.0 x 5.6 x 2.2" (10.2 x 14.2 x 5.6cm)	980TAMTB57

\* Supplied with clear rack and cover

## Cryo Tube Block

Sample Type	No. of Wells	Well Diameter	Well Depth	Dimensions (L x W x H)	Part Number
2.0mL Cryo Tubes	24	0.50" (1.26cm)	1.42" (3.6cm)	4.0 x 5.6 x 2.2" (10.2 x 14.2 x 5.6cm)	980TACTB20

## Conical Tube Blocks

Sample Type	No. of Wells	Well Diameter	Well Depth	Dimensions (L x W x H)	Part Number
5mL Eppendorf Tube Block	9	0.66" (1.68cm)	1.93" (4.9cm)	4.1 x 5.7 x 2.8" (10.4 x 14.5 x 7.1cm)	980TA5MLEPP
15mL Conical Tubes	9	0.68" (1.73cm)	4.11" (10.44cm)	4.2 x 5.7 x 5.0" (10.7 x 14.7 x 12.7cm)	980TACTB15
50mL Conical Tubes	4	1.18" (3.0cm)	3.97" (10.09cm)	4.0 x 5.7 x 4.8" (10.2 x 14.5 x 12.2cm)	980TACTB50

## Replacement Racks and Covers

Description	Part Number
0.5mL Rack	980TA30RCK
1.5mL / 2.0mL Rack	980TA24RCK
0.5mL Rack and Cover	980TA30RKCV
1.5mL / 2.0mL Rack and Cover	980TA24RKCV
Universal Cover	980TACOVER

- Patented Opti-Flow forced ventilation system
- Patented Accu-Drive shaking system
- Calibration mode for temperature and speed

The Talboys Model 5000I Incubating Orbital Shakers are designed for a variety of shaking and incubating applications such as cell cultures.

### Operating Features:

**Accu-Drive Shaking System:** The exclusive patented Accu-Drive Shaking System delivers exceptional speed control, accuracy, and durability. The system continuously monitors shaking speed and maintains set-point, even under changing loads. When unit is set to a speed above 100rpm, the speed accuracy is  $\pm 1\%$  of set speed. When set under 100rpm, speed accuracy is  $\pm 1$  rpm.

**Opti-Flow Forced Ventilation System:** The exclusive patented Opti-Flow Forced Ventilation System uses twin induction fans and air deflectors to deliver exceptional temperature uniformity and stability.

**Microprocessor Control:** The variable speed microprocessor control provides consistent uniform shaking action. Microprocessor will display last set-point and will restart if power is interrupted.

**PID Temperature Controller:** Maintains precise temperature control from ambient  $+5^{\circ}\text{C}$  to  $65^{\circ}\text{C}$ . Easy-to-use controls allow user to adjust temperature in  $1^{\circ}\text{C}$  increments.

**Triple Eccentric Drive:** Permanently lubricated ball bearings and maintenance free, brushless DC motor provide reliable service and continuous duty operation.

**LED Display:** Touch pad controls with easy-to-read, independent LED displays for temperature, speed, and time allow operator to view all settings at once. Provides repeatable and accurate results every time and is easily visible across lab benches. The timer will display elapsed time or, when programmed to user defined limit, will shut off unit when time reaches zero. Display will show last settings, even after power has been turned off.

**Temperature Calibration Mode:** Allows user to calibrate unit to an external temperature device.

**Speed Calibration Mode:** Allows user to automatically recalibrate speed display.

**RS-232 Interface:** Provides two-way communication for data logging and unit control.

### Safety Features:

**Load Sensor:** A built-in load sensor detects unbalanced conditions and automatically reduces rpm to a safe speed, or stops unit, to protect samples.

**Overload Protection:** Audible and visual signals will activate when system detects an obstruction or overload of the tray.

**Overshoot Protection:** Unit will shut down and activate audible and visual alarms if temperature deviates  $\pm 1^{\circ}\text{C}$  from set-point.

**Speed Ramping Feature:** Slowly increases speed to desired set-point to avoid splashing.

**Audible Alarm:** In timed mode, alarm will sound when the time reaches zero. Alarm has optional mute function which can be set from the touch pad controls.

**Polycarbonate Lid:** Permits viewing of samples without disturbing internal temperature. When lid is opened, automatic shut off of the circuit will stop the shaker tray to protect operator.

**Spill Resistant Design:** Channels fluids away from internal components.

**Caution Hot Indicator:** Symbol illuminates when the temperature of the air in the chamber reaches  $40^{\circ}\text{C}$  and remains lit until temperature cools down.



980472

### Operating Conditions:

Units can be run in conditions from  $15$  to  $32^{\circ}\text{C}$  ( $59$  to  $90^{\circ}\text{F}$ ), maximum  $80\%$  relative humidity, non-condensing.

### Applications:

Cell cultures, solubility studies, bacterial suspensions, and extraction procedures.

### Ordering Information:

Unit includes a  $92"$  ( $234\text{cm}$ ) detachable, 3-wire cord and plug (230 volt units are supplied with Euro type plug). Unit is also supplied with a non-skid rubber mat that fits the  $18 \times 18"$  ( $45.7 \times 45.7\text{cm}$ ) tray. **5 year limited warranty on parts and labor.**

**Optional NIST Traceable Calibration Certificate** provided by Troemner's ISO/IEC 17025 accredited laboratory. Multiple data points within the temperature and speed ranges, and time function, are reported on the certificate with the associated uncertainties.

Specifications	
Temperature Range	Ambient $+5^{\circ}\text{C}$ to $65^{\circ}\text{C}$
Temperature Uniformity	$\pm 0.5^{\circ}\text{C}$ at $37^{\circ}\text{C}$
Speed Range	15 to 500rpm
Speed Accuracy	above 100rpm $\pm 1\%$ of set speed below 100rpm $\pm 1$ rpm
Timer	1 second to 160 hours
Orbit	25mm (1")
Maximum Weight Capacity	50lbs (22.7kg)
Tray Material	Aluminum
Tray Dimensions (L x W)	18 x 18" (45.7 x 45.7cm)
Interior Dimensions (L x W x H)	20.6 x 24.8 x 17" (52.3 x 62.9 x 43.18cm)
Overall Dimensions (L x W x H)	32.1 x 26.6 x 23.5" (81.5 x 67.5 x 59.6cm)
Ship Weight	228lbs (103.4kg)

Description	Electrical (50/60 Hz)	Part Number
Model 5000I Incubating Orbital Shaker	120V   8.0 amps   800 watts	980472
Model 5000I Incubating Orbital Shaker	230V   8.0 amps   800 watts	980473
Model 5000I Incubating Orbital Shaker with NIST Traceable Certificate	120V   8.0 amps   800 watts	980472-C
Model 5000I Incubating Orbital Shaker with NIST Traceable Certificate	230V   8.0 amps   800 watts	980473-C

## Professional 5000IR Incubating/Refrigerating Orbital Shaker



- Patented Opti-Flow forced ventilation system
- Patented Accu-Drive shaking system
- Calibration mode for temperature and speed

The Talboys Model 5000IR Incubating/Refrigerating Orbital Shakers are designed for a variety of shaking and incubating applications such as cell cultures.

**Operating Features:**

**Accu-Drive Shaking System:** The exclusive patented Accu-Drive Shaking System delivers exceptional speed control, accuracy, and durability. The system continuously monitors shaking speed and maintains set-point, even under changing loads. When unit is set to a speed above 100rpm, the speed accuracy is  $\pm 1\%$  of set speed. When set under 100rpm, speed accuracy is  $\pm 1$  rpm.

**Opti-Flow Forced Ventilation System:** The exclusive patented Opti-Flow Forced Ventilation System uses a powerful fan and air deflectors to deliver exceptional temperature uniformity and stability.

**Microprocessor Control:** The variable speed microprocessor control provides consistent uniform shaking action. Microprocessor will display last set-point and will restart if power is interrupted.

**PID Temperature Controller:** Maintains precise temperature control from 15°C below ambient to 65°C. Easy-to-use controls allow user to adjust temperature in 1°C increments.

**Triple Eccentric Drive:** Permanently lubricated ball bearings and maintenance free, brushless DC motor provide reliable service and continuous duty operation.

**LED Display:** Touch pad controls with easy-to-read, independent LED displays for temperature, speed, and time allow operator to view all settings at once. Provides repeatable and accurate results every time and is easily visible across lab benches. The timer will display elapsed time or, when programmed to user defined limit, will shut off unit when time reaches zero. Display will show last settings, even after power has been turned off.

**Temperature Calibration Mode:** Allows user to calibrate unit to an external temperature device.

**Speed Calibration Mode:** Allows user to automatically recalibrate speed display.

**RS-232 Interface:** Provides two-way communication for data logging and unit control.

**Safety Features:**

**Load Sensor:** A built-in load sensor detects unbalanced conditions and automatically reduces rpm to a safe speed, or stops unit, to protect samples.

**Overload Protection:** Audible and visual signals will activate when system detects an obstruction or overload of the tray.

**Overshoot Protection:** Unit will shut down and activate audible and visual alarms if temperature deviates  $\pm 1^\circ\text{C}$  from set-point.

**Speed Ramping Feature:** Slowly increases speed to desired set-point to avoid splashing.

**Audible Alarm:** In timed mode, alarm will sound when the time reaches zero. Alarm has optional mute function which can be set from the touch pad controls.

**Polycarbonate Lid:** Permits viewing of samples without disturbing internal temperature. When lid is opened, automatic shut off of the circuit will stop the shaker tray to protect operator.

**Spill Resistant Design:** Channels fluids away from internal components.

**Caution Hot Indicator:** Symbol illuminates when the temperature of the air in the chamber reaches 40°C and remains lit until temperature cools down.



980474

**Operating Conditions:**

Units can be run in conditions from 15 to 32°C (59 to 90°F), maximum 80% relative humidity non-condensing.

**Applications:**

Cell cultures, solubility studies, bacterial suspensions, and extraction procedures.

**Ordering Information:**

Unit includes a 92" (234cm) detachable, 3-wire cord and plug (230 volt units are supplied with Euro type plug). Unit is also supplied with a non-skid rubber mat that fits the 18 x 18" (45.7 x 45.7cm) tray. **5 year limited warranty on parts and labor.**

**Optional NIST Traceable Calibration Certificate** provided by Troemner's ISO/IEC 17025 accredited laboratory. Multiple data points within the temperature and speed ranges, and time function, are reported on the certificate with the associated uncertainties.

Specifications	
Temperature Range	15° below ambient to 65°C
Temperature Uniformity	$\pm 0.5^\circ\text{C}$ at 37°C
Speed Range	15 to 500rpm
Speed Accuracy	above 100rpm $\pm 1\%$ of set speed below 100rpm $\pm 1$ rpm
Timer	1 second to 160 hours
Orbit	25mm (1")
Maximum Weight Capacity	50lbs (22.7kg)
Tray Material	Aluminum
Tray Dimensions (L x W)	18 x 18" (45.7 x 45.7cm)
Interior Dimensions (L x W x H)	20.6 x 24.8 x 17" (52.3 x 62.9 x 43.18cm)
Overall Dimensions (L x W x H)	41.1 x 26.6 x 23.5" (104.4 x 67.5 x 59.6cm)
Ship Weight	295lbs (133.8kg)

Description	Electrical (50/60 Hz)	Part Number
Model 5000IR Incubating/Refrigerating Orbital Shaker	120V   10 amps   800 watts	980474
Model 5000IR Incubating/Refrigerating Orbital Shaker	230V   10 amps   800 watts	980475
Model 5000IR Incubating/Refrigerating Orbital Shaker with NIST Traceable Certificate	120V   10 amps   800 watts	980474-C
Model 5000IR Incubating/Refrigerating Orbital Shaker with NIST Traceable Certificate	230V   10 amps   800 watts	980475-C

- Patented Opti-Flow forced ventilation system
- Patented Accu-Drive shaking system
- Calibration mode for temperature and speed

The Talboys Professional 3500 Incubating Orbital Shaker offers exceptional temperature uniformity and is designed for a variety of shaking and incubating applications, such as cell cultures.

### Operating Features:

**Accu-Drive Shaking System:** The exclusive patented Accu-Drive Shaking System delivers exceptional speed control, accuracy, and durability. The system continuously monitors shaking speed and maintains set-point, even under changing loads. When unit is set to a speed above 100rpm, the speed accuracy is  $\pm 1\%$  of set speed. When set under 100rpm, speed accuracy is  $\pm 1$  rpm.

**Opti-Flow Forced Ventilation System:** The exclusive patented Opti-Flow Forced Ventilation System uses twin induction fans and air deflectors to deliver exceptional temperature uniformity and stability.

**Microprocessor Control:** The variable speed microprocessor control provides consistent uniform shaking action. Microprocessor will display last set-point and will restart if power is interrupted.

**PID Temperature Controller:** Maintains precise temperature control from ambient  $+5^{\circ}\text{C}$  to  $65^{\circ}\text{C}$ . Easy-to-use controls allow users to adjust temperature in  $1^{\circ}\text{C}$  increments. Meets ASTM E1292 specification for temperature uniformity.

**Triple Eccentric Drive:** Permanently lubricated ball bearings and maintenance free, brushless DC motor provide reliable service and continuous duty operation.

**LED Display:** Touch pad controls with easy-to-read, independent LED displays for temperature, speed and time allow operator to view all settings at once. Timer will display elapsed time or when programmed to user defined limit, will shut off unit when time reaches zero. Display will show last used settings, even after power has been turned off.

**Temperature Calibration Mode:** Allows user to calibrate unit to an external temperature device.

**Speed Calibration Mode:** Allows user to automatically recalibrate speed display.

**RS-232 Interface:** Provides two-way communication for data logging and unit control.

### Safety Features:

**Load Sensor:** A built-in load sensor detects unbalanced conditions and automatically reduces rpm to a safe speed to protect samples.

**Overload Protection:** Audible and visual signals will activate when system detects an obstruction or overload of the tray.

**Overshoot Protection:** Audible and visual signals will activate if temperature deviates  $\pm 1^{\circ}\text{C}$  from set-point.

**Speed Ramping Feature:** Slowly increases speed to desired set-point to avoid splashing.

**Audible Alarm:** In timed mode, alarm will sound when the time reaches zero. Alarm has optional mute function which can be set from the touch pad control.

**Caution Hot Indicator:** Symbol illuminates when the temperature of the air in the chamber reaches  $40^{\circ}\text{C}$  and remains lit until temperature cools down.

**Spill-Resistant Design:** Channels fluids away from internal components.

**Polycarbonate Lid:** Permits viewing of samples without disturbing internal temperature. When lid is opened, automatic shut off of the circuit will stop the shaker tray to protect operator.



980188 with platform 980169

### Operating Conditions:

Unit can be run in conditions from  $15$  to  $32^{\circ}\text{C}$  ( $59$  to  $90^{\circ}\text{F}$ ), maximum 80% relative humidity, non-condensing.

### Applications:

Cell cultures, solubility studies, bacterial suspensions, and extraction procedures.

### Ordering Information:

Unit includes a 92" (234cm) detachable, 3-wire cord and plug (230 volt units are supplied with Euro type plug). Unit is also supplied with a 13 x 11" (33 x 27.9cm) non-skid rubber mat. **5 year limited warranty on parts and labor.**

**Optional NIST Traceable Calibration Certificate** provided by Troemner's ISO/IEC 17025 accredited laboratory. Multiple data points within the temperature and speed ranges, and time function, are reported on the certificate with the associated uncertainties.

Specifications	
Temperature Range	Ambient $+5^{\circ}\text{C}$ to $65^{\circ}\text{C}$
Temperature Uniformity	$\pm 0.5^{\circ}\text{C}$ at $37^{\circ}\text{C}$
Speed Range	15 to 500rpm
Speed Accuracy	above 100rpm $\pm 1\%$ of set speed; below 100rpm $\pm 1$ rpm
Timer	1 second to 160 hours
Orbit	19mm (0.75")
Maximum Weight Capacity	35lbs (15.9kg)**
Tray Material	Aluminum
Tray Dimensions (L x W)	13 x 11" (33 x 27.9cm)
Interior Dimensions (L x W x H)	13.4 x 12 x 9.5" (34 x 30.5 x 24.1cm)
Overall Dimensions (L x W x H)	25.5 x 14 x 16" (64.8 x 35.6 x 40.6cm)
Ship Weight	83lbs (37.7kg)

Description	Electrical (50/60 Hz)	Part Number
Professional 3500 Incubating Orbital Shaker	120V   5.0 amps   450 watts	980188
Professional 3500 Incubating Orbital Shaker	230V   5.0 amps   450 watts	980189
Professional 3500 Incubating Orbital Shaker with NIST Traceable Certificate	120V   5.0 amps   450 watts	980188-C
Professional 3500 Incubating Orbital Shaker with NIST Traceable Certificate	230V   5.0 amps   450 watts	980189-C

## Professional Touch 1000-3 Incubating Orbital Shaker



- Intuitive 4.3" color touch screen
- Programmable for 5 separate, 5-step programs
- Visibly track program progress through live status bar
- On-board help screens
- Includes NIST traceable certificate for temperature, speed and time

The Talboys Professional Touch 1000-3 Incubating Orbital Shaker is designed for a wide variety of heating and shaking applications that require consistent and precise results. Tray with built-in mounting holes are used to mount a variety of optional flask clamps or test tube racks directly onto the tray.

#### Operating Features:

**LCD Touch Screen:** Enables faster setting of temperature, speed and time which can be viewed at once. Display features on-screen help topics. Touch screen is compatible with rubber gloves used in labs.

**USB:** USB port can transfer data to a flash drive for data logging, program storage and software updates.

**Program Control:** Program control capabilities allow user programmable operation for automated use and memory. Storage for five separate, 5-step programs, or unlimited number of programs with the use of the USB.

**Pulse Mode Feature:** The unit is equipped with a pulse mode feature ideal for quick mixing.

**Microprocessor Control:** The variable speed microprocessor control provides consistent uniform shaking action. Microprocessor will display last set-point and will restart if power is interrupted (continuous mode).

**PID Temperature Controller:** Maintains precise temperature control from ambient +5°C to 65°C. Easy-to-use controls allow users to adjust temperature in 1°C increments.

**Triple Eccentric Drive:** Permanently lubricated ball bearings and maintenance free, brushless DC motor provide reliable service and continuous duty operation.

**Temperature Calibration Mode:** Allows user to calibrate unit to an external temperature device for up to 6 separate points.

#### Safety Features:

**Overload Protection:** Audible and visual signals will activate when system detects an obstruction or overload of the tray.

**Speed Ramping Feature:** Slowly increases speed to desired set-point to avoid splashing.

**Audible Alarm:** In timed mode, alarm will sound when the time reaches zero.

**Caution Hot Indicator:** Symbol illuminates when the temperature of the air in the chamber reaches 40°C and remains lit until temperature cools down.

**Spill-Resistant Design:** Channels fluids away from internal components.

**Polycarbonate Lid:** Permits viewing of samples without disturbing internal temperature.

**Maximum Temperature Limiting Feature:** Ensures temperature will not exceed user defined limits, allowing the user control of temperature sensitive samples.

#### Operating Conditions:

Unit can be run in conditions from 5 to 40°C (41 to 104°F), maximum 80% relative humidity, non-condensing.

#### Applications:

Cell cultures, bacterial suspensions and hybridizations.



980TAIMNTSUSC

#### Ordering Information:

Unit includes a 92" (234cm) detachable, 3-wire cord and plug (230 volt units are supplied with Euro type plug). **5 year limited warranty on parts and labor.**

**NIST Traceable Calibration Certificate** provided by Troemner's ISO/IEC 17025 accredited laboratory. Multiple data points within the temperature and speed ranges, and time function, are reported on the certificate with the associated uncertainties.

#### Specifications

Temperature Range	Ambient +5°C to 65°C
Temperature Uniformity	± 0.5°C at 37°C
Speed Range	100 to 1200rpm
Speed Accuracy	± 2%
Timer	1 minute to 99 hours, 59 minutes
Orbit	3mm (0.12")
Maximum Weight Capacity	8lbs (3.6kg)
Tray Material	Aluminum
Tray Dimensions (L x W)	11 x 7.75" (27.9 x 19.7cm)
Interior Dimensions (L x W x H)	11.3 x 8.3 x 5.7" (28.7 x 21.1 x 14.5cm)
Overall Dimensions (L x W x H)	17 x 11 x 10.7" (43.2 x 27.9 x 27cm)
Ship Weight	30lbs (13.6kg)

Description	Electrical (50/60 Hz)	Part Number
Professional Touch 1000-3 Incubating Orbital Shaker with NIST Traceable Certificate	120V   3.5 amps   400 watts	980TAIMNTSUSC
Professional Touch 1000-3 Incubating Orbital Shaker with NIST Traceable Certificate	230V   2.0 amps   400 watts	980TAIMNTSEUC

- LED displays for temperature, speed and time
- Timer with audible alarm
- Calibration mode for temperature

The Talboys Professional 1000-3 Incubating Orbital Shakers are designed to heat and shake a variety of samples.

### Operating Features:

**Microprocessor Control:** The variable speed microprocessor control provides consistent uniform shaking action. Microprocessor will display last set-point and will restart if power is interrupted.

**PID Temperature Controller:** Maintains precise temperature control from ambient +5°C to 65°C. Easy-to-use controls allow users to adjust temperature in 1°C increments.

**Triple Eccentric Drive:** Permanently lubricated ball bearings and maintenance free, brushless DC motor provide reliable service and continuous duty operation.

**LED Display:** Touch pad controls with easy-to-read, independent LED displays for temperature, speed and time allow operator to view all settings at once. Provides repeatable and accurate results every time and is easily visible across lab benches. Timer will display elapsed time or, when programmed to user defined limit, will shut off unit when time reaches zero. Display will show last used settings, even after power has been turned off.

**Temperature Calibration Mode:** Allows user to calibrate unit to an external temperature device.

### Safety Features:

**Overload Protection:** Audible and visual signals will activate when system detects an obstruction or overload of the tray.

**Speed Ramping Feature:** Slowly increases speed to desired set-point to avoid splashing.

**Audible Alarm:** In timed mode, alarm will sound when the time reaches zero.

**Caution Hot Indicator:** Symbol illuminates when the temperature of the air in the chamber reaches 40°C and remains lit until temperature cools down.

**Spill-Resistant Design:** Channels fluids away from internal components.

**Polycarbonate Lid:** Permits viewing of samples without disturbing internal temperature.

### Operating Conditions:

Unit can be run in conditions from 5 to 40°C (41 to 104°F), maximum 80% relative humidity, non-condensing.

### Applications:

Cell cultures, bacterial suspensions, and hybridizations.

### Ordering Information:

Unit includes a 92" (234cm) detachable, 3-wire cord and plug (230 volt units are supplied with Euro type plug). **5 year limited warranty on parts and labor.**

**Optional NIST Traceable Calibration Certificate** provided by Troemner's ISO/IEC 17025 accredited laboratory. Multiple data points within the temperature and speed ranges, and time function, are reported on the certificate with the associated uncertainties.



980184

### Specifications

Temperature Range	Ambient +5°C to 65°C
Temperature Uniformity	± 0.5°C at 37°C
Speed Range	100 to 1200rpm
Speed Accuracy	± 2% of set speed
Timer	1 second to 160 hours
Orbit	3mm (0.12")
Maximum Weight Capacity	8lbs (3.6kg)
Tray Material	Aluminum
Tray Dimensions (L x W)	11 x 7.75" (27.9 x 19.7cm)
Interior Dimensions (L x W x H)	11.3 x 8.3 x 5.7" (28.7 x 21.1 x 14.5cm)
Overall Dimensions (L x W x H)	17 x 11 x 10.7" (43.2 x 27.9 x 27cm)
Ship Weight	30lbs (13.6kg)

Description	Electrical (50/60 Hz)	Part Number
Professional 1000-3 Incubating Orbital Shaker	120V   5.0 amps   450 watts	980184
Professional 1000-3 Incubating Orbital Shaker	230V   5.0 amps   450 watts	980185
Professional 1000-3 Incubating Orbital Shaker with NIST Traceable Certificate	120V   5.0 amps   450 watts	980184-C
Professional 1000-3 Incubating Orbital Shaker with NIST Traceable Certificate	230V   5.0 amps   450 watts	980185-C



## Professional Touch 1000MP Incubating Microplate Shaker



- Intuitive 4.3" color touch screen
- Programmable for 5 separate, 5-step programs
- Visibly track program progress through live status bar
- On-board help screens
- Accepts deep-well plates, microplates or microtube racks
- Includes NIST traceable certificate for temperature, speed and time

The Talboys Professional Touch 1000MP Incubating Microplate Shaker is optimized for shaking microplates, deep-well plates and microtubes.

#### Operating Features:

**LCD Touch Screen:** Enables faster setting of temperature, speed and time which can be viewed at once. Display features on-screen help topics. Touch screen is compatible with rubber gloves used in labs.

**USB:** USB port can transfer data to a flash drive for data logging, program storage and software updates.

**Program Control:** Program control capabilities allow user programmable operation for automated use and memory. Storage for five separate, 5-step programs, or unlimited number of programs with the use of the USB.

**Pulse Mode Feature:** The unit is equipped with a pulse mode feature ideal for quick mixing.

**Microprocessor Control:** The variable speed microprocessor control provides consistent uniform shaking action. Microprocessor will display last set-point and will restart if power is interrupted (continuous mode).

**PID Temperature Controller:** Maintains precise temperature control from ambient +5°C to 65°C. Easy-to-use controls allow users to adjust temperature in 1°C increments.

**Triple Eccentric Drive:** Permanently lubricated ball bearings and maintenance free, brushless DC motor provide reliable service and continuous duty operation.

**Temperature Calibration Mode:** Allows user to calibrate unit to an external temperature device for up to 6 separate points.

#### Safety Features:

**Overload Protection:** Audible and visual signals will activate when system detects an obstruction or overload of the tray.

**Speed Ramping Feature:** Slowly increases speed to desired set-point to avoid splashing.

**Audible Alarm:** In timed mode, alarm will sound when the time reaches zero.

**Caution Hot Indicator:** Symbol illuminates when the temperature of the air in the chamber reaches 40°C and remains lit until temperature cools down.

**Spill-Resistant Design:** Channels fluids away from internal components.

**Polycarbonate Lid:** Clear lid permits viewing of samples without disturbing internal temperature. Opaque lid prohibits light exposure to light sensitive samples.

**Maximum Temperature Limiting Feature:** Ensures temperature will not exceed user defined limits, allowing the user control of temperature sensitive samples.

#### Operating Conditions:

Unit can be run in conditions from 5 to 40°C (41 to 104°F), maximum 80% relative humidity, non-condensing.

#### Applications:

Immunoassays and hybridizations.



980TAIMPTSUSC

#### Ordering Information:

Unit includes a 92" (234cm) detachable, 3-wire cord and plug (230 volt units are supplied with Euro type plug). **5 year limited warranty on parts and labor.**

**NIST Traceable Calibration Certificate** provided by Troemner's ISO/IEC 17025 accredited laboratory. Multiple data points within the temperature and speed ranges, and time function, are reported on the certificate with the associated uncertainties.

#### Specifications

Temperature Range	Ambient +5°C to 65°C
Temperature Uniformity	± 0.5°C at 37°C
Speed Range	100 to 1200rpm
Speed Accuracy	± 2%
Timer	1 minute to 99 hours, 59 minutes
Orbit	3mm (0.12")
Maximum Weight Capacity	4 microplates or 2 microtube racks
Tray Material	Aluminum
Tray Dimensions (L x W)	11 x 7.75" (27.9 x 19.7cm)
Interior Dimensions (L x W x H)	11.3 x 8.3 x 5.7" (28.7 x 21.1 x 14.5cm)
Overall Dimensions (L x W x H)	17 x 11 x 10.7" (43.2 x 27.9 x 27cm)
Ship Weight	30lbs (13.6kg)

Description	Electrical (50/60 Hz)	Part Number
Professional Touch 1000MP Incubating Microplate Shaker with NIST Traceable Certificate	120V   3.5 amps   400 watts	980TAIMPTSUSC
Professional Touch 1000MP Incubating Microplate Shaker with NIST Traceable Certificate	230V   2.0 amps   400 watts	980TAIMPTSEUC
Professional Touch 1000MP Incubating Microplate Shaker with Opaque Lid with NIST Traceable Certificate	120V   3.5 amps   400 watts	980TAIMOTSUSC
Professional Touch 1000MP Incubating Microplate Shaker with Opaque Lid with NIST Traceable Certificate	230V   2.0 amps   400 watts	980TAIMOTSEUC

- LED displays for temperature, speed and time
- Timer with audible alarm
- Available with opaque lid for light sensitive samples

The Talboys Professional 1000MP Incubating Orbital Shaker is optimized for shaking microplates, deep-well plates, or micro-tubes.

### Operating Features:

**Microprocessor Control:** The variable speed microprocessor control provides consistent uniform shaking action. Microprocessor will display last set-point and will restart if power is interrupted.

**PID Temperature Controller:** Maintains precise temperature control from ambient +5°C to 65°C. Easy-to-use controls allow users to adjust temperature in 1°C increments.

**Triple Eccentric Drive:** Permanently lubricated ball bearings and maintenance free, brushless DC motor provide reliable service and continuous duty operation.

**LED Display:** Touch pad controls with easy-to-read, independent LED displays for temperature, speed, and time allow operator to view all settings at once. Provides repeatable and accurate results every time and is easily visible across lab benches. Timer will display elapsed time or, when programmed to user defined limit, will shut off unit when time reaches zero. Display will show last used settings, even after power has been turned off.

**Temperature Calibration Mode:** Allows user to calibrate unit to an external temperature device.

### Safety Features:

**Overload Protection:** Audible and visual signals will activate when system detects an obstruction or overload of the tray.

**Speed Ramping Feature:** Slowly increases speed to desired set-point to avoid splashing.

**Audible Alarm:** In timed mode, alarm will sound when the time reaches zero.

**Caution Hot Indicator:** Symbol illuminates when the temperature of the air in the chamber reaches 40°C and remains lit until temperature cools down.

**Spill-Resistant Design:** Channels fluids away from internal components.

**Polycarbonate Lid:** Clear lid permits viewing of samples without disturbing internal temperature. Opaque lid prohibits light exposure to light sensitive samples.

### Operating Conditions:

Unit can be run in conditions from 5 to 40°C (41 to 104°F), maximum 80% relative humidity, non-condensing.

### Applications:

Immunoassays and hybridizations.

### Ordering Information:

Units include a 92" (234cm) detachable, 3-wire cord and plug (230 volt units are supplied with Euro type plug). **5 year limited warranty on parts and labor.**



980180

**Optional NIST Traceable Calibration Certificate** provided by Troemner's ISO/IEC 17025 accredited laboratory. Multiple data points within the temperature and speed ranges, and time function, are reported on the certificate with the associated uncertainties.

### Specifications

Temperature Range	Ambient +5°C to 65°C
Temperature Uniformity	± 0.5°C at 37°C
Speed Range	100 to 1200rpm
Speed Accuracy	± 2%
Timer	1 second to 160 hours
Orbit	3mm (0.12")
Maximum Weight Capacity	4 microplates or 2 micro-tube racks
Tray Material	Aluminum
Tray Dimensions (L x W)	11 x 7.75" (27.9 x 19.7cm)
Overall Dimensions (L x W x H)	17 x 11 x 7.75" (43.2 x 27.9 x 19.7cm)
Ship Weight	30lbs (13.6kg)

Description	Electrical (50/60 Hz)	Part Number
Professional 1000MP Incubating Microplate Shaker	120V   5.0 amps   450 watts	980180
Professional 1000MP Incubating Microplate Shaker	230V   5.0 amps   450 watts	980181
Professional 1000MP Incubating Microplate Shaker with Opaque Lid	120V   5.0 amps   450 watts	980180PL
Professional 1000MP Incubating Microplate Shaker with Opaque Lid	230V   5.0 amps   450 watts	980181PL
Professional 1000MP Incubating Microplate Shaker with NIST Traceable Certificate	120V   5.0 amps   450 watts	980180-C
Professional 1000MP Incubating Microplate Shaker with NIST Traceable Certificate	230V   5.0 amps   450 watts	980181-C
Professional 1000MP Incubating Microplate Shaker with Opaque Lid with NIST Traceable Certificate	120V   5.0 amps   450 watts	980180PL-C
Professional 1000MP Incubating Microplate Shaker with Opaque Lid with NIST Traceable Certificate	230V   5.0 amps   450 watts	980181PL-C

## Professional 1000IC-3 Incubating/Cooling Orbital Shaker



- Heats to 65°C and cools to 10°C below ambient
- LED displays for temperature, speed and time
- Calibration mode for temperature

The Talboys Professional 1000IC-3 Incubating/Cooling Orbital Shaker is microplate ready without the need for any additional accessories. Optional modular blocks can accommodate micro-tubes, centrifuge tubes, vials, or culture tubes. Unit holds microplates or modular blocks with a 5" (12.7cm) tall interior capacity. Ideal for analyses that require a stable, controlled temperature.

#### Operating Features:

**Microprocessor Control:** The variable speed microprocessor control provides consistent uniform shaking action. Microprocessor will display last set-point and will restart if power is interrupted.

**PID Temperature Controller:** Maintains precise temperature control from 10°C below ambient to 65°C. Easy-to-use controls allow users to adjust temperature in 1°C increments.

**Triple Eccentric Drive:** Permanently lubricated ball bearings and maintenance free, brushless DC motor provide reliable service and continuous duty operation.

**LED Display:** Touch pad controls with easy-to-read, independent LED displays for temperature, speed, and time allow operator to view all settings at once. Provides repeatable and accurate results every time and is easily visible across lab benches. Timer will display elapsed time or, when programmed to user defined limit, will shut off unit when time reaches zero. Display will show last used settings, even after power has been turned off.

**Temperature Calibration Mode:** Allows user to calibrate unit to an external temperature device.

#### Safety Features:

**Overload Protection:** Audible and visual signals will activate when system detects an obstruction or overload of the tray.

**Speed Ramping Feature:** Slowly increases speed to desired set-point to avoid splashing.

**Audible Alarm:** In timed mode, alarm will sound when the time reaches zero. Alarm has optional mute function which can be set from the touch pad control.

**Caution Hot Indicator:** Symbol illuminates when the temperature of the air in the chamber reaches 40°C and remains lit until temperature cools down.

**Spill-Resistant Design:** Channels fluids away from internal components.

**Polycarbonate Lid:** Permits viewing of samples without disturbing internal temperature.

#### Operating Conditions:

Unit can be run in conditions from 5 to 40°C (41 to 104°F), maximum 80% relative humidity, non-condensing.

#### Applications:

Cell and bacterial cultures, hybridizations, and enzyme reactions.

#### Ordering Information:

Unit includes a 92" (234cm) detachable, 3-wire cord and plug (230 volt units are supplied with Euro type plug). Units are also supplied with an adapter bracket to hold optional modular blocks. See page 44-45 for block options. **5 year limited warranty on parts and labor.**



980186

**Optional NIST Traceable Calibration Certificate** provided by Troemner's ISO/IEC 17025 accredited laboratory. Multiple data points within the temperature and speed ranges, and time function, are reported on the certificate with the associated uncertainties.

#### Specifications

Temperature Range	10°C below ambient to 65°C
Temperature Uniformity	± 0.5°C at 37°C
Speed Range using Microplates	100 to 1200rpm
Speed Range using Modular Blocks	100 to 600rpm
Speed Accuracy	± 2%
Timer	1 second to 160 hours
Orbit	3mm (0.12")
Maximum Weight Capacity	2 microplates or 2 modular blocks
Overall Dimensions (L x W x H)	17.9 x 11 x 10.5" (45.5 x 27.9 x 26.7cm)
Ship Weight	34lbs (15.4kg)

Description	Electrical (50/60 Hz)	Part Number
Professional 1000IC-3 Incubating/Cooling Orbital Shaker	120V   2.0 amps   200 watts	980186
Professional 1000IC-3 Incubating/Cooling Orbital Shaker	230V   1.0 amps   200 watts	980187
Professional 1000IC-3 Incubating/Cooling Orbital Shaker with NIST Traceable Certificate	120V   2.0 amps   200 watts	980186-C
Professional 1000IC-3 Incubating/Cooling Orbital Shaker with NIST Traceable Certificate	230V   1.0 amps   200 watts	980187-C

## Modular Blocks



Plates



Tubes



Vials

### Modular Blocks

Modular Blocks are constructed from a solid anodized aluminum block. The close contact of tubes to block walls allow for maximum temperature transfer.

**Block dimensions (L x W x H):** 3.75 x 3 x 2" (9.5 x 7.6 x 5.1cm)

**Applications:** Cell cultures, hybridizations, and extraction procedures.

Talboys modular blocks also fit in the Talboys Dry Block Heaters.

Constructed of anodized aluminum, this material is ideal for its temperature conducting and corrosion resistant properties.

### Microcentrifuge Tube Blocks

Single block.

Sample Type	No. of Wells	Well Dia.	Well Depth	Part Number
0.5mL tube	30	7.9mm	27.6mm	949108
1.5mL tube	20	11.1mm	39.1mm	949110
2mL tube	20	11.5mm	38.1mm	949151



### Conical-Bottom Centrifuge Tube Blocks

Single block.

Sample Type	No. of Wells	Well Dia.	Well Depth	Part Number
15mL tube	12	17.1mm	44.5mm	949131
50mL tube	5	29.0mm	47.6mm	949127



## Modular Blocks

## Standard Test Tube Blocks

Single block.

Sample Type	No. of Wells	Well Dia.	Well Depth	Part Number
6mm tube	30	8.3mm	48.4mm	949109
10mm tube	24	10.7mm	48.4mm	949102
12/13mm tube	20	13.9mm	48.4mm	949103



## Centrifuge Tube Combination Block

Single block. These blocks have been designed for variable sized samples.

Sample Type	No. of Wells	Well Dia.	Well Depth	Part Number
1.5mL	4	11.1mm	39.1mm	
15mL	3	17.1mm	44.5mm	949153
50mL	2	29.0mm	47.6mm	



## Vial Blocks

Single block. Designed for sample/serum and scintillation vials.

Sample Type	No. of Wells	Well Dia.	Well Depth	Part Number
12mm vial	20	12.7mm	30mm	949142
15mm vial	20	15.8mm	35mm	949143
16mm vial	15	16.4mm	45mm	949150
17mm vial	12	17.8mm	45mm	949144
19mm vial	12	19.7mm	45mm	949145
21mm vial	9	21.7mm	45mm	949146
23mm vial	8	23.8mm	45mm	949147
25mm vial	8	25.8mm	45mm	949148
28mm vial	6	28.8mm	45mm	949149



- Intuitive 4.3" color touch screen
- Programmable for 5 separate, 5-step programs
- Visibly track program progress through live status bar
- On-board help screens
- Electronic tilt adjustment from 0 to 15° while unit is operating
- Includes NIST traceable certificate for temperature, speed and time

The Talboys Professional Touch 1000RS Incubating Rocking Shaker combines smooth rocking motion and general purpose incubation in one bench top unit.

### Operating Features:

**LCD Touch Screen:** Enables faster setting of temperature, speed, tilt angle and time which can be viewed at once. Display features on-screen help topics. Touch screen is compatible with rubber gloves used in labs.

**USB:** USB port can transfer data to a flash drive for data logging, program storage and software updates.

**Program Control:** Program control capabilities allow user programmable operation for automated use and memory. Storage for five separate, 5-step programs, or unlimited number of programs with the use of the USB.

**Pulse Mode Feature:** The unit is equipped with a pulse mode feature ideal for quick rocking.

**Microprocessor Control:** The variable speed microprocessor control provides electronic tilt angle and speed adjustments which allows the user to easily adjust rocking angle and speed while the unit is operating. Precise speed and tilt angle control provides smooth, low speed rocking motion down to 1rpm. Microprocessor will display last set-point and will restart if power is interrupted (continuous mode).

**PID Temperature Controller:** Maintains precise temperature control from ambient +5°C to 65°C. Easy-to-use controls allow users to adjust temperature in 1°C increments.

**Temperature Calibration Mode:** Allows user to calibrate unit to an external temperature device for up to 6 separate points.

### Safety Features:

**Overload Protection:** Audible and visual signals will activate when system detects an obstruction or overload of the tray.

**Speed Ramping Feature:** Slowly increases speed to desired set-point to avoid splashing.

**Audible Alarm:** In timed mode, alarm will sound when the time reaches zero.

**Caution Hot Indicator:** Symbol illuminates when the temperature of the air in the chamber reaches 40°C and remains lit until temperature cools down.

**Spill-Resistant Design:** Channels fluids away from internal components.

**Polycarbonate Lid:** Permits viewing of samples without disturbing internal temperature.

**Maximum Temperature Limiting Feature:** Ensures temperature will not exceed user defined limits, allowing the user control of temperature sensitive samples.

### Operating Conditions:

Unit can be run in conditions from 5 to 40°C (41 to 104°F), maximum 80% relative humidity, non-condensing.

### Applications:

Cell cultures, staining and destaining gels, hybridizations, and blotting techniques.

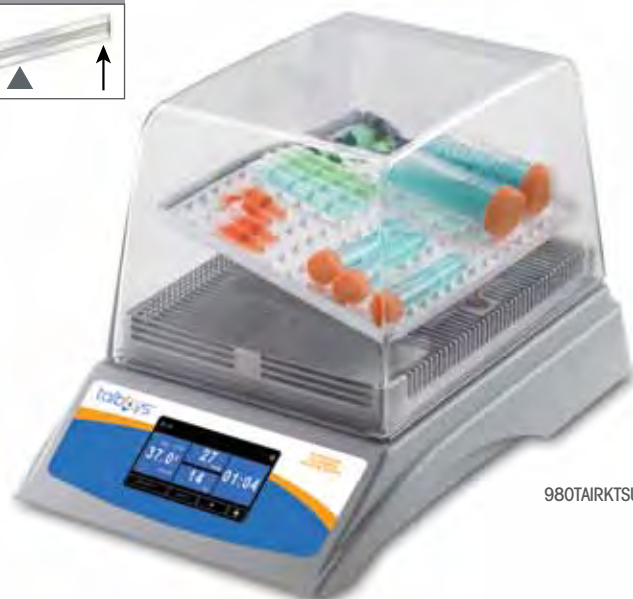

980TAIRKTSUSC

### Ordering Information:

Unit includes a 92" (234cm) detachable, 3-wire cord and plug (230 volt units are supplied with Euro type plug). **5 year limited warranty on parts and labor.**

**NIST Traceable Calibration Certificate** provided by Troemner's ISO/IEC 17025 accredited laboratory. Multiple data points within the temperature and speed ranges, and time function, are reported on the certificate with the associated uncertainties.

Specifications	
Temperature Range	Ambient +5°C to 65°C
Temperature Uniformity	± 0.5°C at 37°C
Speed Range	1 to 50rpm*
Speed Accuracy	± 1rpm
Tilt Angle	0 to 15° *
Timer	1 minute to 99 hours, 59 minutes
Maximum Weight Capacity	10lbs (4.5kg)**
Tray Material	Aluminum
Tray Dimensions (L x W)	10 x 7.5" (25.4 x 19.1cm)
Interior Dimensions (L x W x H)	10.75 x 7.75 x 3.8" (27.3 x 19.7 x 9.7cm)
Overall Dimensions (L x W x H)	17 x 11 x 10.5" (43.2 x 27.9 x 26.7cm)
Ship Weight	22lbs (10kg)

\* Maximum speed/tilt angle may vary with heavy or unbalanced loads.

\*\* Centered on tray.

Description	Electrical (50/60 Hz)	Part Number
Professional Touch 1000RS Incubating Rocking Shaker with NIST Traceable Certificate	120V   3.5 amps   400 watts	980TAIRKTSUSC
Professional Touch 1000RS Incubating Rocking Shaker with NIST Traceable Certificate	230V   2.0 amps   400 watts	980TAIRKTSEUC

## Professional 1000RS Incubating Rocking Shaker



- Electronic tilt adjustment from 0 to 15° while unit is operating
- LED displays for temperature, speed and tilt angle, and time
- Timer with audible alarm

The Talboys Professional 1000RS Incubating Rocking Shaker combines smooth rocking motion and general purpose incubation in one compact bench top unit.

### Operating Features:

**Microprocessor Control:** The microprocessor control provides electronic tilt angle adjustment which allows user to easily adjust rocking angle from 0 to 15° while unit is operating. Precise speed control provides smooth, low-speed rocking motion down to 1rpm.

**PID Temperature Controller:** Maintains precise temperature control from ambient +5°C to 65°C. Easy-to-use controls allow users to adjust temperature in 1°C increments.

**LED Display:** Touch pad controls with easy-to-read, independent LED displays for temperature, speed and tilt angle, and time allow operator to view all settings at once. Provides repeatable and accurate results every time and is easily visible across lab benches. Timer will display elapsed time or, when programmed to user defined limit, will shut off unit when time reaches zero. Display will show last used settings, even after power has been turned off.

### Safety Features:

**Overload Protection:** Audible and visual signals will activate when system detects an obstruction or overload of the tray.

**Speed Ramping Feature:** Slowly increases speed to desired set-point to avoid splashing.

**Audible Alarm:** In timed mode, alarm will sound when the time reaches zero.

**Caution Hot Indicator:** Symbol illuminates when the temperature of the air in the chamber reaches 40°C and remains lit until temperature cools down.

**Spill-Resistant Design:** Channels fluids away from internal components.

**Polycarbonate Lid:** Permits viewing of samples without disturbing internal temperature.

### Operating Conditions:

Unit can be run in conditions from 5 to 40°C (41 to 104°F), maximum 80% relative humidity, non-condensing.

### Applications:

Cell cultures, staining and destaining gels, hybridization procedures, and blotting techniques.

### Ordering Information:

Unit includes a 92" (234cm) detachable, 3-wire cord and plug (230 volt units are supplied with Euro type plug). **5 year limited warranty on parts and labor.**

**Optional NIST Traceable Calibration Certificate** provided by Troemner's ISO/IEC 17025 accredited laboratory. Multiple data points within the temperature and speed ranges, and time function, are reported on the certificate with the associated uncertainties.



980532

### Specifications

Temperature Range	Ambient +5°C to 65°C
Temperature Uniformity	± 0.5°C at 37°C
Speed Range	1 to 50rpm *
Speed Accuracy	± 1rpm
Tilt Angle	0 to 15° *
Timer	1 second to 160 hours
Maximum Weight Capacity	10lbs (4.5kg) **
Tray Material	Aluminum
Tray Dimensions (L x W)	10 x 7.5" (25.4 x 19.1cm)
Interior Dimensions (L x W x H)	10.75 x 7.75 x 3.8" (27.3 x 19.7 x 9.7cm)
Overall Dimensions (L x W x H)	17 x 11 x 10.5" (43.2 x 27.9 x 26.7cm)
Ship Weight	22lbs (10kg)

\* Maximum speed/tilt angle may vary with heavy or unbalanced loads.

\*\* Centered on tray.

Description	Electrical (50/60 Hz)	Part Number
Professional 1000RS Incubating Rocking Shaker	120V   5.0 amps   450 watts	980532
Professional 1000RS Incubating Rocking Shaker	230V   5.0 amps   450 watts	980533
Professional 1000RS Incubating Rocking Shaker with NIST Traceable Certificate	120V   5.0 amps   450 watts	980532-C
Professional 1000RS Incubating Rocking Shaker with NIST Traceable Certificate	230V   5.0 amps   450 watts	980533-C

- Intuitive 4.3" color touch screen
- Programmable for 5 separate, 5-step programs
- Visibly track program progress through live status bar
- On-board help screens
- Electronic tilt adjustment from 0 to 20° while unit is operating
- Includes NIST traceable certificate for temperature, speed and time

The Talboys Professional Touch 1000WS Incubating Waving Shaker combines the unique vertical and horizontal "wave" motion with general purpose incubation in one compact bench top unit.

### Operating Features:

**LCD Touch Screen:** Enables faster setting of temperature, speed, tilt angle, and time which can be viewed at once. Display features on-screen help topics. Touch screen is compatible with rubber gloves used in labs.

**USB:** USB port can transfer data to a flash drive for data logging, program storage and software updates.

**Program Control:** Program control capabilities allow user programmable operation for automated use and memory. Storage for five separate, 5-step programs, or unlimited number of programs with the use of the USB. The unit can be programmed to wave in a clockwise, counter-clockwise or both motions within a program, for the most thorough mixing.

**Pulse Mode Feature:** The unit is equipped with a pulse mode feature ideal for quick waving.

**Microprocessor Control:** The variable speed microprocessor control provides electronic tilt angle and speed adjustments which allows the user to easily adjust waving angle and speed while the unit is operating. Precise speed and tilt angle control provides smooth, low speed rocking waving down to 1rpm. Microprocessor will display last set-point and will restart if power is interrupted (continuous mode).

**PID Temperature Controller:** Maintains precise temperature control from ambient +5°C to 65°C. Easy-to-use controls allow users to adjust temperature in 1°C increments.

**Temperature Calibration Mode:** Allows user to calibrate unit to an external temperature device for up to 6 separate points.

### Safety Features:

**Overload Protection:** Audible and visual signals will activate when system detects an obstruction or overload of the tray.

**Speed Ramping Feature:** Slowly increases speed to desired set-point to avoid splashing.

**Audible Alarm:** In timed mode, alarm will sound when the time reaches zero.

**Caution Hot Indicator:** Symbol illuminates when the temperature of the air in the chamber reaches 40°C and remains lit until temperature cools down.

**Spill-Resistant Design:** Channels fluids away from internal components.

**Polycarbonate Lid:** Permits viewing of samples without disturbing internal temperature.

**Maximum Temperature Limiting Feature:** Ensures temperature will not exceed user defined limits, allowing the user control of temperature sensitive samples.

### Operating Conditions:

Unit can be run in conditions from 5 to 40°C (41 to 104°F), maximum 80% relative humidity, non-condensing.

### Applications:

Cell cultures, staining and destaining gels, hybridizations, and blotting techniques.

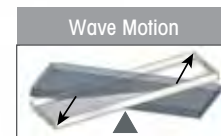

980TAIRWTSUSC

### Ordering Information:

Unit includes a 92" (234cm) detachable, 3-wire cord and plug (230 volt units are supplied with Euro type plug). **5 year limited warranty on parts and labor.** **NIST Traceable Calibration Certificate** provided by Troemner's ISO/IEC 17025 accredited laboratory. Multiple data points within the temperature and speed ranges, and time function, are reported on the certificate with the associated uncertainties.

Specifications	
Temperature Range	Ambient +5°C to 65°C
Temperature Uniformity	± 0.5°C at 37°C
Speed Range	1 to 30rpm*
Speed Accuracy	± 1rpm
Tilt Angle	0 to 20° *
Timer	1 minute to 99 hours, 59 minutes
Maximum Weight Capacity	5lbs (2.3kg)**
Tray Material	Aluminum
Tray Dimensions (L x W)	9.25 x 7.25" (23.5 x 18.4cm)
Interior Dimensions (L x W x H)	10.75 x 7.75 x 3.4" (27.3 x 19.7 x 8.6cm)
Overall Dimensions (L x W x H)	17 x 11 x 10.5" (43.2 x 27.9 x 26.7cm)
Ship Weight	22lbs (10kg)

\* Maximum speed/tilt angle may vary with heavy or unbalanced loads.

\*\* Centered on tray.

Description	Electrical (50/60 Hz)	Part Number
Professional Touch 1000WS Incubating Waving Shaker with NIST Traceable Certificate	120V   3.5 amps   400 watts	980TAIRWTSUSC
Professional Touch 1000WS Incubating Waving Shaker with NIST Traceable Certificate	230V   2.0 amps   400 watts	980TAIRWTSEUC



## Professional 1000WS Incubating Waving Shaker



- Electronic tilt adjustment from 0 to 20° while unit is operating
- LED displays for temperature, speed and tilt angle, and time
- Timer with audible alarm

The Talboys Professional 1000WS Incubating Waving Shaker combines the unique vertical and horizontal “wave” motion with general purpose incubation in one compact bench top unit.

### Operating Features:

**Microprocessor Control:** The microprocessor control provides electronic tilt angle adjustment which allows user to easily adjust waving angle from 0 to 20° while unit is operating. Precise speed control provides smooth, low-speed waving motion down to 1rpm.

**PID Temperature Controller:** Maintains precise temperature control from ambient +5°C to 65°C. Easy-to-use controls allow users to adjust temperature in 1°C increments..

**LED Display:** Touch pad controls with easy-to-read, independent LED displays for temperature, speed and tilt angle, and time allow operator to view all settings at once. Provides repeatable and accurate results every time and is easily visible across lab benches. Timer will display elapsed time or, when programmed to user defined limit, will shut off unit when time reaches zero. Display will show last used settings, even after power has been turned off.

### Safety Features:

**Overload Protection:** Audible and visual signals will activate when system detects an obstruction or overload of the tray.

**Speed Ramping Feature:** Slowly increases speed to desired set-point to avoid splashing.

**Audible Alarm:** In timed mode, alarm will sound when the time reaches zero.

**Caution Hot Indicator:** Symbol illuminates when the temperature of the air in the chamber reaches 40°C and remains lit until temperature cools down.

**Spill-Resistant Design:** Channels fluids away from internal components.

**Polycarbonate Lid:** Permits viewing of samples without disturbing internal temperature.

### Operating Conditions:

Unit can be run in conditions from 5 to 40°C (41 to 104°F), maximum 80% relative humidity, non-condensing.

### Applications:

Cell cultures, hybridization procedures, and blotting techniques.

### Ordering Information:

Unit includes a 92" (234cm) detachable, 3-wire cord and plug (230 volt units are supplied with Euro type plug). **5 year limited warranty on parts and labor.**

**Optional NIST Traceable Calibration Certificate** provided by Troemner's ISO/IEC 17025 accredited laboratory. Multiple data points within the temperature and speed ranges, and time function, are reported on the certificate with the associated uncertainties.



980539

### Specifications

Temperature Range	Ambient +5°C to 65°C
Temperature Uniformity	± 0.5°C at 37°C
Speed Range	1 to 30rpm *
Speed Accuracy	± 1rpm
Tilt Angle	0 to 20° *
Timer	1 second to 160 hours
Maximum Weight Capacity	5lbs (2.3kg) **
Tray Material	Aluminum
Tray Dimensions (L x W)	9.25 x 7.25" (23.5 x 18.4cm)
Interior Dimensions (L x W x H)	10.75 x 7.75 x 3.4" (27.3 x 19.7 x 8.6cm)
Overall Dimensions (L x W x H)	17 x 11 x 10.5" (43.2 x 27.9 x 26.7cm)
Ship Weight	22lbs (10kg)

\* Maximum speed/tilt angle may vary with heavy or unbalanced loads.

\*\* Centered on tray.

Description	Electrical (50/60 Hz)	Part Number
Professional 1000WS Incubating Waving Shaker	120V   5.0 amps   450 watts	980539
Professional 1000WS Incubating Waving Shaker	230V   5.0 amps   450 watts	980540
Professional 1000WS Incubating Waving Shaker with NIST Traceable Certificate	120V   5.0 amps   450 watts	980539-C
Professional 1000WS Incubating Waving Shaker with NIST Traceable Certificate	230V   5.0 amps   450 watts	980540-C

## Platforms

### Universal Platforms

Allows for mounting of flask clamps, test tube racks, and bottle clamps. Platform slides over top of included tray and is tightened with adjustment screws. Optional accessories screw directly into mounting point openings. The two-tier braces allow stacking of platforms with a 10" clearance (available for select sizes). An optional non-skid rubber mat can be placed on the platform for an added non-slip surface. The platform is constructed of type 304 stainless steel.



Description	Used on Shakers	Part Number
11 x 13" (27.9 x 33cm) Universal Platform	Standard/Advanced/Professional 3500, Advanced 3750	980169
13 x 13" (33 x 33cm) Universal Platform	Standard/Advanced 3500, Advanced 3750	980434
18 x 18" (45.7 x 45.7cm) Universal Platform*	Standard/Advanced 3500, Advanced 3750**	980435
18 x 18" (45.7 x 45.7cm) Universal Platform	Professional 5000I/5000IR	980483
18 x 24" (45.7 x 61cm) Universal Platform*	Standard/Advanced 3500, Advanced 3750**, Standard/Advanced 5000**	980436
24 x 24" (61 x 61cm) Universal Platform	Advanced 10000-1 / 10000-2	980437
18 x 30" (45.7 x 76.2cm) Universal Platform*	Standard/Advanced 5000	980438
24 x 36" (61 x 91.4cm) Universal Platform	Advanced 15000-1 / 15000-2	980439
Two-Tier Braces (set of 4)	Standard/Advanced 3500, Standard/Advanced 5000	980077

### Rubber Mats

Description	Used on Shakers	Part Number
13 x 13" (33 x 33cm) Rubber Mat	Standard/Advanced 3500, Advanced 3750	980094
18 x 18" (45.7 x 45.7cm) Rubber Mat	Standard/Advanced 3500, Advanced 3750, Professional 5000I/IR	980095
24 x 24" (61 x 61cm) Rubber Mat	Advanced 10000-1 / 10000-2	980096
24 x 36" (61 x 91.4cm) Rubber Mat	Advanced 15000-1 / 15000-2	980097

### Culture Platforms

Ideal for slow speed applications; Petri dishes, culture flasks, and other flat bottom, low profile vessels. The two-tier braces (available for both sizes) allow stacking of platforms with a 10" clearance. The platform is constructed of type 304 stainless steel. The platform has a non-skid rubber surface.



Description	Used on Shakers	Part Number
18 x 18" (45.7 x 45.7cm) Culture Platform*	Standard/Advanced 3500, Advanced 3750**	980440
18 x 24" (45.7 x 61cm) Culture Platform*	Standard/Advanced 3500, Advanced 3750**, Standard/Advanced 5000	980441
Two-Tier Braces (set of 4)	Standard/Advanced 3500, Standard/Advanced 5000	980077

\* Two tier ready

\*\* Stacking of platforms is not recommended for Model 3750 and Model 5000

## Platforms

## Dedicated Platforms

Pre-mounted flask clamps for maximum utilization of platform space for flasks of all one size. The two-tier braces allow stacking of platforms with a clearance (available for select sizes). Platform is constructed of type 304 stainless steel. Flask clamps are constructed of PVC. Ideal for polycarbonate flasks.



Description	Flask Capacity	Used on Shakers	Part Number
13 x 13" (33 x 33cm) Dedicated Platform / 125mL Flask Clamp	16	Standard/Advanced 3500, Advanced 3750	980449
13 x 13" (33 x 33cm) Dedicated Platform / 250mL Flask Clamp	12	Standard/Advanced 3500, Advanced 3750	980450
13 x 13" (33 x 33cm) Dedicated Platform / 500mL Flask Clamp	8	Standard/Advanced 3500, Advanced 3750	980451
13 x 13" (33 x 33cm) Dedicated Platform / 1L Flask Clamp	4	Standard/Advanced 3500, Advanced 3750	980452
18 x 18" (45.7 x 45.7cm) Dedicated Platform / 125mL Flask Clamp*	27	Standard/Advanced 3500, Advanced 3750**	980453
18 x 18" (45.7 x 45.7cm) Dedicated Platform / 250mL Flask Clamp*	20	Standard/Advanced 3500, Advanced 3750**	980454
18 x 18" (45.7 x 45.7cm) Dedicated Platform / 500mL Flask Clamp*	13	Standard/Advanced 3500, Advanced 3750**	980455
18 x 18" (45.7 x 45.7cm) Dedicated Platform / 1L Flask Clamp	9	Standard/Advanced 3500, Advanced 3750**	980456
Two-Tier Braces (set of 4)		Standard/Advanced 3500	980077

## Adjustable Platforms

Adjustable clamping bars accommodate various vessel types. Constructed of stainless steel. The base tray has a non-skid rubber surface.

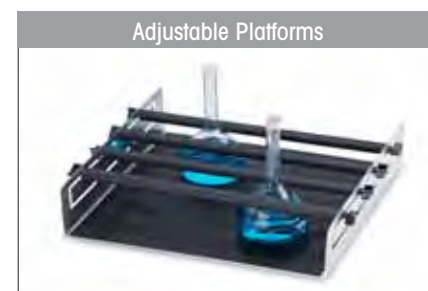

Description	Bar Size	Overall Dimensions	Used on Shakers	Part Number
2-bar Adjustable Platform	8.6" (21.8cm)	8.6 x 11.7" (21.8 x 29.7cm)	Advanced 1000-3/1000-15	980197
4-bar Adjustable Platform	18" (45.7cm)	18 x 18" (45.7 x 45.7cm)	Standard/Advanced 3500	980442
4-bar Adjustable Platform	18" (45.7cm)	18 x 24" (45.7 x 61cm)	Standard/Advanced 5000	980443

## Replacement Parts

Description	Used with Platforms	Part Number
8.6" (21.8cm) adjustable bar (with mounting hardware)	980197	980470
18" (45.7cm) adjustable bar (with mounting hardware)	980442, 980443	980447

\* Two tier ready

\*\* Stacking of platforms is not recommended for Model 3750

### Large Vessel Carrier Platforms

Ideal for large sample containers like carboys, jugs, and bottles. The platforms' high side walls secure samples, has a heavy-duty design and is constructed of stainless steel. The base tray has a non-skid rubber surface.



Description	Bar Size	Overall Dimensions (L x W x H)	Used on Shakers	Part Number
4-bar Large Vessel Carrier Platform	18" (45.7cm)	30.1 x 18.1 x 13.9 (76.4 x 45.9 x 35.3cm)	Standard/Advanced 5000	980444
4-bar Large Vessel Carrier Platform	24" (61cm)	24.4 x 24.3 x 14.2 (61.9 x 61.7 x 36.0cm)	Advanced 10000-1 / 10000-2	980445
5-bar Large Vessel Carrier Platform	24" (61cm)	36.9 x 24.3 x 14.2 (93.7 x 61.7 x 36.0cm)	Advanced 15000-1 / 15000-2	980446

Replacement Part	Used with Carrier	Part Number
18" (45.7cm) adjustable bar (with mounting hardware)	980444	980447
24" (61cm) adjustable bar (with mounting hardware)	980445, 980446	980448

### Separatory Funnel Platform

Holds 3 funnels at once on an 18 x 18" (45.7 x 45.7cm) platform. Platform can accommodate 500mL to 2L separatory funnels and is constructed of stainless steel. Includes platform, clamps and hardware to secure 3 funnels.



Description	Used on Shakers	Part Number
Separatory Funnel Platform	Standard/Advanced 3500, Advanced 3750	980457

### Microplate Clamp

Can hold one standard microplate or deep-well plate. Constructed of type 304 stainless steel.

Platform Capacities for Microplate Clamps		
Platform Size	Platform Part Number	Microplate Clamps
11 x 13	980169	4
13 x 13	980434	6
18 x 18	980435	12
18 x 18	980483	12
18 x 24	980436	18
18 x 30	980438	21
24 x 24	980437	24
24 x 36	980439	36



Description	Used on Shakers	Part Number
Microplate Clamp	Standard/Advanced/Professional 3500, 5000, 1000, 15000	980458

## Accessories

**Universal Harness**

Attaches to tray to secure low profile plates.

Description	Used on Shakers	Part Number
Universal Harness	Advanced 1000-3 / 1000-15	980192

Universal Harness

**Dimpled Mat**

Designed to hold centrifuge tubes, vials, culture tubes, and micro-tubes securely in place. Mat can easily be removed for cleaning and transporting of tubes from bench to tray.

Description	Used on Shakers	Part Number
Dimpled Mat, 12.75 x 10" (32.4 x 25.4cm)	Advanced 1000RS Rocking Shaker	980535
Dimpled Mat, 11.75 x 8.75" (29.9 x 22.2cm)	Advanced 1000WS Waving Shaker	980542
Dimpled Mat, 10 x 7.5" (25.4 x 19.1cm)	Professional 1000RS Incubating Rocking Shaker	980536
Dimpled Mat, 9.25 x 7.25" (23.5 x 18.4cm)	Professional 1000WS Incubating Waving Shaker	980543
Dimpled Mat, 11.75 x 8.75" (29.9 x 22.2cm)	Advanced 1000-3 / 1000-15	980190
Dimpled Mat, 14 x 11" (35.6 x 27.9cm)	Standard 1000RS Rocking/1000WS Waving Shakers	980TADMAR

Dimpled Mat

**Stacking Tray**

Easily attaches to the units' included tray to add a second tier for higher capacity applications. Second tier tray mounts 3.5" (8.9cm) above lower tray. The tray includes hardware and a rubber mat.

Description	Used on Shakers	Part Number
Stacking Tray, 12.75 x 10" (32.4 x 25.4cm)	Advanced 1000RS Rocking Shaker	980534
Stacking Tray, 11.75 x 8.75" (29.9 x 22.2cm)	Advanced 1000WS Waving Shaker	980541
Stacking Tray, 14 x 11" (35.6 x 27.9cm)	Standard 1000RS Rocking Shaker	980TASTKTRAY

Stacking Tray

**Dilution Cup Tray**

Constructed of type 304 stainless steel. Holds 24 x 28mm dilution vials.

Description	Used on Unit	Part Number
Dilution Rack Tray, 6.9 x 10" (17.5 x 25.4cm)	Advanced 1000-3 / 1000-15	980200

Dilution Cup Tray

**Micro-Tube Rack**

Optional 1.5 to 2mL Micro-Tube Rack attaches to tray to hold up to 70 x 1.5mL or 2mL micro-tubes. Tray can accommodate up to 2 micro-tube racks.

Description	Used on Unit	Part Number
1.5 to 2mL Micro-Tube Rack	Advanced/Professional 1000MP	980191

Micro-Tube Rack











## Flask Clamps

### Stainless Steel Flask Clamps

Designed to hold Erlenmeyer flasks from 10mL to 6L. Constructed of type 302 and 304 stainless steel. Includes hardware for easy attachment to platforms. Flask clamps 50mL and higher are supplied with a spring to hold the flask in place. The 2.8L clamp is designed to hold a Fernbach flask. Media bottle clamps feature the same details as flask clamps.



Clamp Style								
	10mL Erlenmeyer Flask Clamp	25mL Erlenmeyer Flask Clamp	50mL Erlenmeyer Flask Clamp	125mL Erlenmeyer Flask Clamp	250mL Erlenmeyer Flask Clamp	500mL Erlenmeyer Flask Clamp	1L Erlenmeyer Flask Clamp	2L Erlenmeyer Flask Clamp
Material	Stainless Steel	Stainless Steel	Stainless Steel	Stainless Steel	Stainless Steel	Stainless Steel	Stainless Steel	Stainless Steel
Part Number	980078	980079	980080	980081	980082	980083	980086	980087
Tray or Platform	Number of Flask Clamps per Tray or Platform							
11.75 x 8.75" (29.9 x 22.2cm)								
Advanced 1000-3/1000-15*	35	20	15	12	6	4	N/A	N/A
11 x 7.75" (27.9 x 19.7cm)								
Professional 1000-3*	35	20	12	8	5	N/A	N/A	N/A
11 x 13" (27.9 x 33cm)								
Standard/Advanced 3500	60	25	13	10	9	7	4	N/A
Professional 3500	60	25	13	10	9	7	4	N/A
Advanced 3750	60	25	13	10	9	7	4	N/A
13 x 13" (33cm x 33cm)								
Standard/Advanced 3500	60	30	15	12	12	8	4	3
Advanced 3750	60	30	15	12	12	8	4	3
18 x 18" (45.7 x 45.7cm)								
Standard/Advanced 3500	113	64	32	20	20	13	8	5
Advanced 3750	113	64	32	20	20	13	8	5
5000I / 5000IR	113	64	32	20	20	13	8	5
18 x 24" (45.7 x 61cm)								
Standard/Advanced 3500	158	88	44	28	28	20	12	6
Advanced 3750	158	88	44	28	28	20	12	6
Standard/Advanced 5000	158	88	44	28	28	20	12	6
18 x 30" (45.7 x 76.2cm)								
Standard/Advanced 5000	203	112	56	36	36	26	15	8
24 x 24" (61 x 61cm)								
Advanced 10000-1/10000-2	221	121	61	41	41	25	16	9
24 x 36" (61 x 91.4cm)								
Advanced 15000-1/15000-2	336	160	94	61	64	40	24	14

\* All units require a universal platform for mounting flask clamps or test tube racks with the exception of the Advanced 1000-3, 1000-15, and the Professional 1000-3

Flask Clamps

**PVC Flask Clamps**

Constructed of one piece, molded PVC. Autoclavable. Will not scratch or mark flask like other clamps. Includes hardware for easy attachment to universal platforms. The attachment and removal of flasks is quick and easy. Ideal for polycarbonate flasks.



2.8L & 3L Fernbach Flask Clamp	4L Erlenmeyer Flask Clamp	6L Erlenmeyer Flask Clamp	500mL Media Bottle Clamp	1L Media Bottle Clamp	125mL Erlenmeyer Flask Clamp	250mL Erlenmeyer Flask Clamp	500mL Erlenmeyer Flask Clamp	1L Erlenmeyer Flask Clamp	2L Erlenmeyer Flask Clamp
Stainless Steel	Stainless Steel	Stainless Steel	Stainless Steel	Stainless Steel	PVC	PVC	PVC	PVC	PVC
2.8L - 980088 3L - 980106	980089	980090	980092	980093	980428	980429	980430	980431	980432

**Number of Flask Clamps per Tray or Platform**

N/A	N/A	N/A	3	N/A	12	6	4	N/A	N/A
N/A	N/A	N/A	N/A	N/A	8	4	N/A	N/A	N/A
N/A	N/A	N/A	5	2	10	8	5	2	N/A
N/A	N/A	N/A	5	2	10	8	5	2	N/A
N/A	N/A	N/A	5	2	10	8	5	2	N/A
1	1	1	6	5	12	10	6	4	3
1	1	1	6	5	12	10	6	4	3
2	4	2	16	10	20	18	12	8	4
2	4	2	16	10	20	18	12	8	4
2	4	2	16	10	20	18	12	8	4
3	4	3	20	13	28	25	16	10	6
3	4	3	20	13	28	25	16	10	6
3	4	3	20	13	28	25	16	10	6
3	6	4	28	18	36	33	20	14	8
5	5	5	25	18	41	35	24	13	9
7	9	7	40	30	61	55	38	22	13

## Test Tube Racks

### Test Tube Racks – Half Size, Stationary

Racks constructed of PVC coated steel. Includes hardware for easy attachment to platforms.  
 Dimensions are: 5L x 7W x 4H" (12.7 x 17.8 x 10.2cm) / Micro-Tube Rack: 1.7H" (4.3cm).



Test Tube Style	1.5 to 2mL Micro-Tube Rack	10 to 13mm Test Tube Rack	14 to 16mm Test Tube Rack	18 to 20mm Test Tube Rack	22 to 25mm Test Tube Rack	15mL Centrifuge Tube Rack	50mL Centrifuge Tube Rack
	Half Size, Stationary	Half Size, Stationary	Half Size, Stationary	Half Size, Stationary	Half Size, Stationary	Half Size, Stationary	Half Size, Stationary
<b>Tube Capacity</b>	70	63	48	35	24	35	12
<b>Part Number</b>	980191	980193	980194	980195	980196	980198	980199
<b>Tray or Platform</b>	<b>Number of Test Tube Racks per Tray or Platform</b>						
11.75 x 8.75" (29.9 x 22.2cm)							
Advanced 1000-3/1000 15 *	2	2	2	2	2	2	2
11 x 7.75" (27.9 x 19.7cm)							
Professional 1000-3*	2	1	1	N/A	N/A	1	1
Advanced 1000MP*	2	N/A	N/A	N/A	N/A	N/A	N/A
Professional 1000MP*	2	N/A	N/A	N/A	N/A	N/A	N/A
11 x 13" (27.9 x 33cm)							
Standard/Advanced 3500	2	2	2	2	2	2	2
Professional 3500	2	2	2	2	2	2	2
Advanced 3750	2	2	2	2	2	2	2
13 x 13" (33cm x 33cm)							
Standard/Advanced 3500	2	2	2	2	2	2	2
Advanced 3750	2	2	2	2	2	2	2
18 x 18" (45.7 x 45.7cm)							
Standard/Advanced 3500	4	4	4	4	4	4	4
Advanced 3750	4	4	4	4	4	4	4
5000I / 5000IR	4	4	4	4	4	4	4
18 x 24" (45.7 x 61cm)							
Standard/Advanced 3500	6	6	6	6	6	6	6
Advanced 3750	6	6	6	6	6	6	6
Standard/Advanced 5000	6	6	6	6	6	6	6
18 x 30" (45.7 x 76.2cm)							
Standard/Advanced 5000	8	8	8	8	8	8	8
24 x 24" (61 x 61cm)							
Advanced 10000-1/10000-2	8	8	8	8	8	8	8
24 x 36" (61 x 91.4cm)							
Advanced 15000-1/15000-2	7	7	7	7	7	7	7

\* All units require a universal platform for mounting flask clamps or test tube racks with the exception of the Advanced 1000-3, 1000-15, 1000MP and the Professional 1000-3 and 1000MP



Test Tube Racks

**Test Tube Racks – Full Size, Stationary**

Racks constructed of PVC coated steel. Includes hardware for easy attachment to platforms. Dimensions are: 3.75L x 16.5W x 4H" (9.5 x 41.9 x 10.2cm)

**Test Tube Racks - Full Size, Pivoting**

Has adjustable angle, custom tilt. Stainless steel holder includes removable plastic rack. Rack is easily removed to transport from work area to shaker. The inside pivoting rack has dimensions of 5.1 x 10.8 x 3.9" (12.9 x 27.4 x 9.9cm). The outside stationary rack has dimensions of 5.0 x 10.9 x 5" (12.7 x 27.6 x 12.7cm)

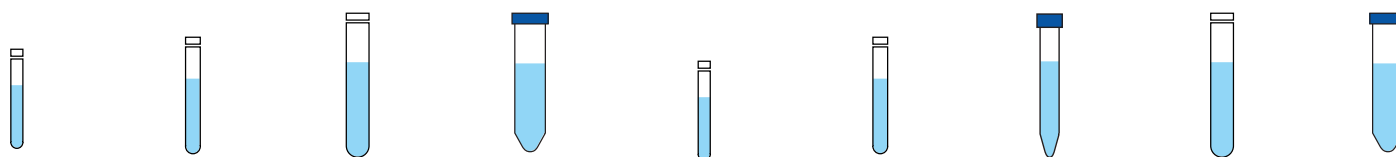

10 to 14mm Test Tube Rack	16 to 20mm Test Tube Rack	21 to 25mm Test Tube Rack	50mL Centrifuge Tube Rack	13mm Test Tube Rack	16mm Test Tube Rack	20mm Test Tube Rack	25mm Test Tube Rack	30mm Test Tube Rack
Full Size, Stationary	Full Size, Stationary	Full Size, Stationary	Full Size, Stationary	Full Size, Pivoting	Full Size, Pivoting	Full Size, Pivoting	Full Size, Pivoting	Full Size, Pivoting
48	33	21	17	90	60	40	24	21
980040	980041	980042	980043	980459	980460	980461	980462	980463

Number of Test Tube Racks per Tray or Platform

N/A	N/A	N/A	N/A	N/A	N/A	N/A	N/A	N/A
N/A	N/A	N/A	N/A	N/A	N/A	N/A	N/A	N/A
N/A	N/A	N/A	N/A	N/A	N/A	N/A	N/A	N/A
N/A	N/A	N/A	N/A	N/A	N/A	N/A	N/A	N/A
N/A	N/A	N/A	N/A	1	1	1	1	1
N/A	N/A	N/A	N/A	1	1	1	1	1
N/A	N/A	N/A	N/A	1	1	1	1	1
N/A	N/A	N/A	N/A	2	2	2	2	2
N/A	N/A	N/A	N/A	2	2	2	2	2
3	3	3	3	2	2	2	2	2
3	3	3	3	2	2	2	2	2
3	3	3	3	2	2	2	2	2
5	5	5	5	3	3	3	3	3
5	5	5	5	3	3	3	3	3
5	5	5	5	3	3	3	3	3
6	6	6	6	4	4	4	4	4
7	7	7	7	4	4	4	4	4
5	5	5	5	6	6	6	6	6







Professional Hotplates,  
Stirrers &  
Hotplate-Stirrers



Advanced Hotplates,  
Stirrers &  
Hotplate-Stirrers



Professional Round Top  
Hotplate-Stirrers



Advanced Round Top  
Hotplate-Stirrers



Basic Mini Hotplates,  
Stirrers &  
Hotplate-Stirrers

Top Plate Dimensions (L x W)	7 x 7", 10 x 10"	4 x 4", 7 x 7", 10 x 10"	5.3" Diameter	5.3" Diameter	4.5" Diameter
Overall Dimensions (L x W x H)	See page 60	See page 62	14.8 x 9.9 x 4.3" (37.6 x 25.1 x 10.9cm)	14.8 x 9.9 x 4.3" (37.6 x 25.1 x 10.9cm)	6.5 x 5.75 x 4.75" (16.5 x 14.6 x 12.1cm)
Temperature Range	Ambient +5° to 500°C	Ambient +5° to 500°C	N/A	N/A	N/A
Ceramic	Ambient +5° to 400°C	Ambient +5° to 400°C	N/A	N/A	to 400°C
Aluminum	N/A	N/A	Ambient +5° to 400°C	Ambient +5° to 400°C	N/A
Stainless Steel					
Temperature Stability					
Ceramic	± 1%*	± 3%**	N/A	N/A	N/A
Aluminum	± 1%*	± 2%**	± 1%***	± 3%**	N/A
Stainless Steel	N/A	N/A	± 1%***	± 3%**	N/A
Speed Range	60 to 1600rpm	60 to 1600rpm	60 to 1600rpm	60 to 1600rpm	100 to 1200rpm
Speed Stability	± 2%	± 2%	± 2%	± 2%	± 2%
Timer (Digital Models)	1 second to 160 hours	N/A	1 second to 160 hours	N/A	N/A
Maximum Capacity (H <sub>2</sub> O)	2500mL, 6000mL	600mL, 2500mL, 6000mL	1500mL	1500mL	1000mL
Ship Weight	See Page 60	See Page 62	11.7lbs (5.3kg)	9.4lbs (4.3kg)	4.5lbs (2kg)

\* Plate Control: Below 100°C ±2°C. Environmental and sample conditions permitting.  
Probe Control: Below 100°C ±1°C. Environmental and sample conditions permitting.

\*\* Below 100°C ±2°C. Environmental and sample conditions permitting.  
\*\*\* Below 100°C ±1°C. Environmental and sample conditions permitting.

### How to Select a Hotplate/Stirrer

Review the following points to help you select the appropriate hotplate/stirrer for your unique application.

#### 1. Control Types

The **Professional** series offers a closed loop PID microprocessor for both temperature and speed control, but additionally offers electronic feedback for control of both temperature and speed. These units offer the best in accuracy and precision. A built-in timer allows for greater independence. Also included with the Professional series Hotplates and Hotplate-Stirrers is an external stainless steel temperature probe. It guarantees the utmost in sample temperature monitoring and control, delivering ±1% temperature stability and supplied with a 12" flexible arm and three interchangeable clamps.

The **Advanced** series is very accurate and offers a closed loop PID microprocessor for both temperature and speed which automatically stabilizes the top plate for temperature and or stirring speeds by regulating for variations in the system with regards to the original set-point. Utilizing electronic user feedback, it offers the most optimal measure for temperature control by providing greater accuracy and ease-in-use for reproducing your results.

The **Basic Mini** series offers an open loop speed control and a mechanical thermostat that is not designed for exact regulation over speed or temperature. When precision is not needed these units offer an economical and reliable alternative.

#### 2. Temperature needs

Temperature uniformity refers to the consistency of the temperature across the top plate. Each top plate material has its pros and cons. Ceramic top plates are more chemical resistant, heat up very quickly, and are easy to clean. The white reflective surface aids in viewing the sample. However; ceramic tops are subject to thermal shock. Heating of metallic vessels should be avoided. The edges of a ceramic top plate may not be as hot as the center where the heating element is located. Aluminum top plates offer a more uniform heating surface, will not crack or chip but are more susceptible to corrosion and more difficult to clean.

## Hotplate/Stirrer Selection Guide

Standard / Advanced  
High Volume StirrersAdvanced Large Capacity  
Stirrer Model 1000 /  
Model 2000Standard / Advanced  
Multi-Position StirrersStandard / Advanced  
Slow Speed Stirrers  
4 Position / 10LStandard / Advanced  
Slow Speed Stirrers  
1 Position

12.5 x 11"	21.25 x 25"	12.5 x 11"	12.5 x 11"	7 x 7"
17 x 11 x 3.8" (43.2 x 27.9 x 9.7cm)	28.5 x 26.75 x 5.25" (72.4 x 68 x 13.3cm)	17 x 11 x 4" (43.2 x 27.9 x 10.2cm)	17 x 11 x 4" (43.2 x 27.9 x 10.2cm)	21.1 x 8.5 x 3.5" (53.6 x 21.6 x 8.9cm)
N/A N/A N/A	N/A N/A N/A	N/A N/A N/A	N/A N/A N/A	N/A N/A N/A
N/A N/A N/A	N/A N/A N/A	N/A N/A N/A	N/A N/A N/A	N/A N/A N/A
60 to 1400rpm	100 to 1800 rpm	60 to 1400rpm	1 to 150rpm	1 to 150rpm
± 2%	± 2%	± 2%	±1%	± 1%
1 second to 160 hours	1 second to 160 hours	1 second to 160 hours	1 second to 160 hours	1 second to 160 hours
25L	100L / 200L	See Page 70	1L / 10L	2L
14.6lbs (6.6kg)	63lbs (28.6kg)	14.75lbs (6.69kg)	14.5lbs (6.6kg)	8.8lbs (4kg)

### 3. Sample size

The size or volume of your sample is another important factor to consider when selecting a hotplate or stirrer. Always consider the largest sample that you may be working with and look for one that can handle that capacity. The capacities listed are based on water. A viscous sample will weigh more than water.

### 4. Viscosity

Sample viscosity plays a role in selecting a stirrer. The magnetic coupling strength is a factor in determining which size stirrer to choose. The right drive magnet and stir bar combination is needed to efficiently stir the sample. Variables such as sample size or weight and top plate size dictate which stirrer will work best. The stir bar size and shape, the distance between the drive magnet and the stir bar, vessel shape and size, speed and viscosity also must be considered. The more viscous the sample, the greater magnetic coupling strength needed.

- Intuitive 4.3" color touch screen
- Programmable for 5 separate, 5-step programs
- Visibly track program progress through live status bar
- On-board help screens
- Programmable temperature ramping (4 options)
- Includes NIST traceable certificate for temperature, speed and time

The Talboys Professional Touch Hotplate-Stirrers are designed for applications that require exceptional accuracy, stability and repeatability. Exclusive safety features help protect operator and sample. Enhanced microprocessor control offers an external RTD probe option that delivers superior temperature control of the sample. Includes PT1000 RTD temperature probe kit.

**Operating Features:**

**Low Profile Design:** Takes up minimal space and fits easily into fume hoods. Rear housing features an off centered, built-in Spill-resistant design channels fluids away from internal components.

**LCD Touch Screen:** LCD touch screen enables faster setting of temperature and time, which can be viewed at once. Display features on-screen help topics. Touch screen is compatible with rubber gloves used in labs.

**USB:** USB port can transfer data to a flash drive for data logging, program storage and software updates.

**Program Control:** Program control capabilities allow user programmable operation for automated use and memory. Storage for five separate, 5-step programs, or unlimited number of programs with the use of the USB.

**Pulse Mode Feature:** The unit is equipped with a pulse mode feature ideal for quick stirring.

**Microprocessor Control:** Advanced electronics regulate both heating and stirring and bring samples to temperature quickly and efficiently. An internal RTD accurately measures and controls temperature with minimal overshoot. Precise speed control provides consistent stirring at all speeds. Powerful continuous duty motor delivers dependable and reliable stirring.

**Ceramic Top Plate Material:** Ceramic tops feature a chemical resistant, reflective white top plate surface that is easy to clean.

**Built-In Support Rod Holder:** Rear housing features an off-centered, built-in support rod holder with locking knob that accepts the RTD probe kit.

**RTD Probe Kit:** Heating models are supplied with a probe kit which includes an 8" (20.3cm) stainless steel PT1000 RTD temperature probe, 12" (30.5cm) flex arm, interchangeable 3-prong clamp head, 2-prong clamp head and spring clamp head.

**Temperature Calibration Mode:** Allows user to calibrate to an external temperature device for up to 6 separate points.

**Safety Features:**

**Cool Touch Housing:** Housing is made of a heat resistant polymer that is not only cool to the touch, but is also chemical resistant.

**Spill Resistant Design:** Channels fluids away from internal components.

**Caution Hot Indicator:** For additional safety, hot symbol warning light is illuminated when heat is turned on and remains on until top plate cools down (for heating models).

**Stir Protection:** If stirrer motor stops or fails, unit will automatically shut down heater (for hotplate-stirrers).

**Programmable Temperature Ramping Feature:** Allows user greater control over their assay when changing temperatures within a program.

**Speed Ramping Feature:** Slowly increases motor speed for improved safety and enhanced coupling. Avoids splashing, improves spin bar control, and provides excellent low end speed control (for stirrers or hotplate-stirrers).



984TA7CHSTSUSC

**Maximum Temperature Limiting (Plate Over Temperature Limit):** Ensures plate temperature will never exceed users programmed set temperature limit, allowing for control of samples with sensitive flash points (heating models).

**Audible Alarm:** In timed mode, alarm will sound when time reaches zero or when unit reaches set-point temperature (for hotplates or hotplate-stirrers).

**Probe Protection:** If probe disengages from sample, unit will automatically shut off heater (heating models).

**Operating Conditions:**

Unit can be run in conditions from 5 to 40°C (41 to 104°F), maximum 20% to 80% relative humidity, non-condensing.

**Ordering Information:**

Units include a 92" (234cm) detachable, 3-wire cord and plug (230V units are supplied with Euro type plug). Stirrers and hotplate-stirrers are supplied with a 1.5" (3.8cm) PTFE coated stir bar. Hotplates and hotplate-stirrers are supplied with a probe kit which includes an 8" (20.3cm) stainless steel PT1000 RTD temperature probe, 12" (30.5cm) flex arm, and interchangeable 3-prong clamp head, 2-prong clamp head and spring clamp head. **5 year limited warranty on parts and labor.**

**NIST Traceable Calibration Certificate** provided by Troemner's ISO/IEC 17025 accredited laboratory. Multiple data points within the temperature and speed ranges, and time function, are reported on the certificate with the associated uncertainties. **Replacement probes** are available, see accessories on page 74.

## Professional Touch Hotplates, Stirrers & Hotplate-Stirrers



### Specifications

Top Plate Dimensions	7 x 7" (17.8 x 17.8cm)
Top Plate Material	Ceramic
Temperature Range	Ambient +5°C to 500°C
Temperature Stability*	± 1%
Speed Range	60 to 1600rpm
Speed Stability	± 2%
Timer	1 minute to 99 hours, 59 minutes
Maximum Capacity (H <sub>2</sub> O)	2500mL
Overall Dimensions (L x W x H)	14.8 x 9.9 x 4.3" (37.6 x 25 x 10.9cm)
Ship Weight	12lbs (5.4kg)

\* Plate control below 100°C ± 2°C. Environmental and sample conditions permitting.



984TA7CSTTSUSC

### Professional Touch Hotplates

Description	Top Plate Material	Electrical (50/60 Hz)	Part Number
7 x 7" (17.8 x 17.8cm) Touch Hotplate with NIST Traceable Certificate	Ceramic	120V   7.9 amps   950 watts	984TA7CHPTSUSC
7 x 7" (17.8 x 17.8cm) Touch Hotplate with NIST Traceable Certificate	Ceramic	230V   4.4 amps   1000 watts	984TA7CHPTSEUC

### Professional Touch Stirrers

Description	Top Plate Material	Electrical (50/60 Hz)	Part Number
7 x 7" (17.8 x 17.8cm) Touch Stirrer with NIST Traceable Certificate	Ceramic	120V   0.4 amps   50 watts	984TA7CSTTSUSC
7 x 7" (17.8 x 17.8cm) Touch Stirrer with NIST Traceable Certificate	Ceramic	230V   0.2 amps   50 watts	984TA7CSTTSEUC

### Professional Touch Hotplate-Stirrers

Description	Top Plate Material	Electrical (50/60 Hz)	Part Number
7 x 7" (17.8 x 17.8cm) Touch Hotplate-Stirrer with NIST Traceable Certificate	Ceramic	120V   8.3 amps   1000 watts	984TA7CHSTSUSC
7 x 7" (17.8 x 17.8cm) Touch Hotplate-Stirrer with NIST Traceable Certificate	Ceramic	230V   4.6 amps   1050 watts	984TA7CHSTSEUC

- Excellent temperature uniformity
- Cool touch, chemical resistant housing
- Includes RTD temperature probe kit

Talboys Professional Hotplates, Stirrers, and Hotplate-Stirrers are designed for applications that require exceptional accuracy, stability, and repeatability. Exclusive safety features help protect operator and sample. Enhanced microprocessor control offers an external RTD probe option that delivers superior temperature control of the sample. Stirring function, with continuous duty motor and powerful magnet, maintains set speed even under changing load or viscosity. Separate LED displays for temperature, speed, and time allow user to view all settings at once.

### Operating Features:

**Low Profile Design:** Takes up minimal space and fits easily into fume hoods. Spill-resistant design channels fluids away from internal components.

**Microprocessor Control:** Advanced electronics regulate both heating and stirring and bring samples to temperature quickly and efficiently. An internal RTD accurately measures and controls temperature. Precise speed control provides consistent stirring at all speeds. Powerful continuous duty motor delivers dependable and reliable stirring.

**Control Panel:** Touch pad controls with easy-to-read, independent LED displays for temperature, speed, and time allow operator to view all settings at once. Provides repeatable and accurate results every time and is easily visible from outside fume hoods or across lab benches. Shows set-point and actual temperatures. Timer will display elapsed time or, when programmed to user defined limit, will shut off unit when time reaches zero. Display will show last used settings, even after power has been turned off.

**Ceramic or Aluminum Top Plate Materials:** Ceramic tops feature a chemical resistant, reflective white top plate surface that is easy to clean. Durable aluminum tops will not crack or chip, and provide a more even temperature distribution.

**Built-In Support Rod Holder:** Rear housing features an off-centered, built-in support rod holder with locking knob that accepts the probe kit supplied with heating models.

**RTD Probe Kit:** Heating models are supplied with a probe kit which includes an 8" (20.3cm) stainless steel PT1000 RTD temperature probe, 12" (30.5cm) flex arm, interchangeable 3-prong clamp head, 2-prong clamp head and spring clamp head.

### Safety Features:

**Cool Touch Housing:** Housing is made of a heat resistant polymer that is not only cool to the touch, but is also chemical resistant.

**Hot Top Indicator:** For additional safety, hot symbol warning light is illuminated when heat is turned on and remains on until top plate cools down (for hotplates or hotplate-stirrers).

**Stir Protection:** If stirrer motor stops or fails, unit will automatically shut down heater (for hotplate-stirrers).

**Speed Ramping Feature:** Slowly increases motor speed for improved safety and enhanced coupling. Avoids splashing, improves spin bar control, and provides excellent low end speed control (for stirrers or hotplate-stirrers).

**Maximum Temperature Limiting (Plate Over Temperature Limit):** Ensures plate temperature will never exceed users programmed set temperature limit, allowing for control of samples with sensitive flash points (for hotplates or hotplate-stirrers).

**Audible Alarm:** In timed mode, alarm will sound when time reaches zero or when unit reaches set-point temperature (for hotplates or hotplate-stirrers).

**Probe Protection:** If probe disengages from sample, unit will automatically shut off heater (for hotplates or hotplate-stirrers).



984TA7CHSUSP

### Operating Conditions:

Unit can be run in conditions from 5 to 40°C (41 to 104°F), 20% to 80% relative humidity, non-condensing.

### Ordering Information:

Units include a 92" (234cm) detachable, 3-wire cord and plug (230V units are supplied with Euro type plug). Stirrers and hotplate-stirrers are supplied with a 1.5" (3.8cm) PTFE coated stir bar. Hotplates and hotplate-stirrers are supplied with a probe kit which includes an 8" (20.3cm) stainless steel PT1000 RTD temperature probe, 12" (30.5cm) flex arm, and interchangeable 3-prong clamp head, 2-prong clamp head and spring clamp head. **5 year limited warranty on parts and labor.**

### Specifications

Top Plate Dimensions	
7 x 7" Units	7 x 7" (17.8 x 17.8cm)
10 x 10" Units	10 x 10" (25.4 x 25.4cm)
Temperature Range	
Ceramic Top Plate Units	Ambient +5°C to 500°C
Aluminum Top Plate Units	Ambient +5°C to 400°C
Temperature Stability*	± 1%
Speed Range	60 to 1600rpm
Speed Stability	± 2%
Timer	1 second to 160 hours
Maximum Capacity (H <sub>2</sub> O)	
7 x 7" Units	2500mL
10 x 10" Units	6000mL
Overall Dimensions (L x W x H)	
7 x 7" Units	14.8 x 9.9 x 4.3" (37.6 x 25 x 10.9cm)
10 x 10" Units	17.9 x 13 x 4.3" (45.5 x 33 x 10.9cm)
Ship Weight	
7 x 7" Units	12lbs (5.4kg)
10 x 10" Units	17.4lbs (7.9kg)

\* Plate Control: Below 100°C ± 2°C. Environmental and sample conditions permitting.

\* Probe Control: Below 100°C ± 1°C. Environmental and sample conditions permitting.



## Professional Hotplates, Stirrers &amp; Hotplate-Stirrers

**Optional NIST Traceable Calibration Certificate** provided by Troemner's ISO/IEC 17025 accredited laboratory. Multiple data points within the temperature and speed ranges, and time function, are reported on the certificate with the associated uncertainties. **Replacement probes** are available, see accessories on page 74.

Professional Hotplates			
Description	Top Plate Material	Electrical (50/60 Hz)	Part Number
7 x 7" (17.8 x 17.8cm) Hotplate	Ceramic	120V   7.9 amps   950 watts	984TA7CHPUSP
7 x 7" (17.8 x 17.8cm) Hotplate	Ceramic	230V   4.4 amps   1000 watts	984TA7CHPEUP
7 x 7" (17.8 x 17.8cm) Hotplate	Aluminum	120V   7.9 amps   950 watts	984TA7AHPUSP
7 x 7" (17.8 x 17.8cm) Hotplate	Aluminum	230V   4.4 amps   1000 watts	984TA7AHEUP
7 x 7" (17.8 x 17.8cm) Hotplate with NIST Traceable Certificate	Ceramic	120V   7.9 amps   950 watts	984TA7CHPUSC
7 x 7" (17.8 x 17.8cm) Hotplate with NIST Traceable Certificate	Ceramic	230V   4.4 amps   1000 watts	984TA7CHPEUC
7 x 7" (17.8 x 17.8cm) Hotplate with NIST Traceable Certificate	Aluminum	120V   7.9 amps   950 watts	984TA7AHPUSC
7 x 7" (17.8 x 17.8cm) Hotplate with NIST Traceable Certificate	Aluminum	230V   4.4 amps   1000 watts	984TA7AHEUC
10 x 10" (25.4 x 25.4cm) Hotplate	Ceramic	120V   12.5 amps   1500 watts	984TA0CHPUSP
10 x 10" (25.4 x 25.4cm) Hotplate	Ceramic	230V   6.7 amps   1550 watts	984TA0CHPEUP
10 x 10" (25.4 x 25.4cm) Hotplate	Aluminum	120V   12.5 amps   1500 watts	984TA0AHPUSP
10 x 10" (25.4 x 25.4cm) Hotplate	Aluminum	230V   6.7 amps   1550 watts	984TA0AHEUP
10 x 10" (25.4 x 25.4cm) Hotplate with NIST Traceable Certificate	Ceramic	120V   12.5 amps   1500 watts	984TA0CHPUSC
10 x 10" (25.4 x 25.4cm) Hotplate with NIST Traceable Certificate	Ceramic	230V   6.7 amps   1550 watts	984TA0CHPEUC
10 x 10" (25.4 x 25.4cm) Hotplate with NIST Traceable Certificate	Aluminum	120V   12.5 amps   1500 watts	984TA0AHPUSC
10 x 10" (25.4 x 25.4cm) Hotplate with NIST Traceable Certificate	Aluminum	230V   6.7 amps   1550 watts	984TA0AHEUC

Professional Stirrers			
Description	Top Plate Material	Electrical (50/60 Hz)	Part Number
7 x 7" (17.8 x 17.8cm) Stirrer	Ceramic	120V   0.4 amps   50 watts	984TA7CSTUSP
7 x 7" (17.8 x 17.8cm) Stirrer	Ceramic	230V   0.2 amps   50 watts	984TA7CSTEUP
7 x 7" (17.8 x 17.8cm) Stirrer	Aluminum	120V   0.4 amps   50 watts	984TA7ASTUSP
7 x 7" (17.8 x 17.8cm) Stirrer	Aluminum	230V   0.2 amps   50 watts	984TA7ASTEUP
7 x 7" (17.8 x 17.8cm) Stirrer with NIST Traceable Certificate	Ceramic	120V   0.4 amps   50 watts	984TA7CSTUSC
7 x 7" (17.8 x 17.8cm) Stirrer with NIST Traceable Certificate	Ceramic	230V   0.2 amps   50 watts	984TA7CSTEUC
7 x 7" (17.8 x 17.8cm) Stirrer with NIST Traceable Certificate	Aluminum	120V   0.4 amps   50 watts	984TA7ASTUSC
7 x 7" (17.8 x 17.8cm) Stirrer with NIST Traceable Certificate	Aluminum	230V   0.2 amps   50 watts	984TA7ASTEUC
10 x 10" (25.4 x 25.4cm) Stirrer	Ceramic	120V   0.4 amps   50 watts	984TA0CSTUSP
10 x 10" (25.4 x 25.4cm) Stirrer	Ceramic	230V   0.2 amps   50 watts	984TA0CSTEUP
10 x 10" (25.4 x 25.4cm) Stirrer	Aluminum	120V   0.4 amps   50 watts	984TA0ASTUSP
10 x 10" (25.4 x 25.4cm) Stirrer	Aluminum	230V   0.2 amps   50 watts	984TA0ASTEUP
10 x 10" (25.4 x 25.4cm) Stirrer with NIST Traceable Certificate	Ceramic	120V   0.4 amps   50 watts	984TA0CSTUSC
10 x 10" (25.4 x 25.4cm) Stirrer with NIST Traceable Certificate	Ceramic	230V   0.2 amps   50 watts	984TA0CSTEUC
10 x 10" (25.4 x 25.4cm) Stirrer with NIST Traceable Certificate	Aluminum	120V   0.4 amps   50 watts	984TA0ASTUSC
10 x 10" (25.4 x 25.4cm) Stirrer with NIST Traceable Certificate	Aluminum	230V   0.2 amps   50 watts	984TA0ASTEUC

Professional Hotplate-Stirrers			
Description	Top Plate Material	Electrical (50/60 Hz)	Part Number
7 x 7" (17.8 x 17.8cm) Hotplate-Stirrer	Ceramic	120V   8.3 amps   1000 watts	984TA7CHSUSP
7 x 7" (17.8 x 17.8cm) Hotplate-Stirrer	Ceramic	230V   4.6 amps   1050 watts	984TA7CHSEUP
7 x 7" (17.8 x 17.8cm) Hotplate-Stirrer	Aluminum	120V   8.3 amps   1000 watts	984TA7AHSUSP
7 x 7" (17.8 x 17.8cm) Hotplate-Stirrer	Aluminum	230V   4.6 amps   1050 watts	984TA7AHSEUP
7 x 7" (17.8 x 17.8cm) Hotplate-Stirrer with NIST Traceable Certificate	Ceramic	120V   8.3 amps   1000 watts	984TA7CHSUSC
7 x 7" (17.8 x 17.8cm) Hotplate-Stirrer with NIST Traceable Certificate	Ceramic	230V   4.6 amps   1050 watts	984TA7CHSEUC
7 x 7" (17.8 x 17.8cm) Hotplate-Stirrer with NIST Traceable Certificate	Aluminum	120V   8.3 amps   1000 watts	984TA7AHSUSC
7 x 7" (17.8 x 17.8cm) Hotplate-Stirrer with NIST Traceable Certificate	Aluminum	230V   4.6 amps   1050 watts	984TA7AHSEUC
10 x 10" (25.4 x 25.4cm) Hotplate-Stirrer	Ceramic	120V   12.9 amps   1550 watts	984TA0CHSUSP
10 x 10" (25.4 x 25.4cm) Hotplate-Stirrer	Ceramic	230V   7.0 amps   1600 watts	984TA0CHSEUP
10 x 10" (25.4 x 25.4cm) Hotplate-Stirrer	Aluminum	120V   12.9 amps   1550 watts	984TA0AHSUSP
10 x 10" (25.4 x 25.4cm) Hotplate-Stirrer	Aluminum	230V   7.0 amps   1600 watts	984TA0AHSEUP
10 x 10" (25.4 x 25.4cm) Hotplate-Stirrer with NIST Traceable Certificate	Ceramic	120V   12.9 amps   1550 watts	984TA0CHSUSC
10 x 10" (25.4 x 25.4cm) Hotplate-Stirrer with NIST Traceable Certificate	Ceramic	230V   7.0 amps   1600 watts	984TA0CHSEUC
10 x 10" (25.4 x 25.4cm) Hotplate-Stirrer with NIST Traceable Certificate	Aluminum	120V   12.9 amps   1550 watts	984TA0AHSUSC
10 x 10" (25.4 x 25.4cm) Hotplate-Stirrer with NIST Traceable Certificate	Aluminum	230V   7.0 amps   1600 watts	984TA0AHSEUC

- Excellent temperature uniformity
- Cool touch, chemical resistant housing
- LED display for temperature

Talboys Advanced Hotplates, Stirrers and Hotplate-Stirrers deliver accurate and repeatable results. These units are microprocessor controlled and have an LED display for temperature. Control panel features easy-to-use controls which allow users to dial in adjustments. Rear housing features an integral support rod holder with locking knob to accept the optional support rod and clamp kit.

### Operating Features:

**Low Profile Design:** Takes up minimal space and fits easily into fume hoods. Spill-resistant design channels fluids away from internal components.

**LED Display:** Shows set-point temperature. Display is easy-to-read and provides repeatable and accurate results every time.

**Control Panel:** Adjustment knob for temperature displays set-point in LED display. Stir control knob has rpm adjustment markings.

**Recall Last Temperature:** Built-in memory allows users to recall last set temperature, even when unit has been turned off.

**Microprocessor Control:** Advanced electronics regulate both heating and stirring and bring samples to temperature quickly and efficiently. An internal RTD accurately measures and controls temperature. Precise speed control provides consistent stirring at all speeds. Powerful continuous duty motor delivers dependable and reliable stirring.

**Heating Capacity:** Robust heater allows heating surface to reach set-point quickly.

**Ceramic or Aluminum Top Plate Materials:** Ceramic tops feature a chemical resistant, reflective white top plate surface that is easy to clean. Durable aluminum tops will not crack or chip, and provide a more even temperature distribution.

**Built-In Support Rod Holder:** Rear housing features an off-centered, built-in support rod holder with locking knob that accepts the optional Support Rod and Clamp Kit.

### Safety Features:

**Cool Touch Housing:** Housing is made of a heat resistant polymer that is not only cool to the touch, but is also chemical resistant.

**Hot Top Indicator:** For additional safety, hot symbol warning light is illuminated when heat is turned on and remains on until top plate cools down, (for hotplates or hotplate-stirrers).

**Stir Protection:** If stirrer motor stops or fails, unit will automatically shut down heater (for hotplate-stirrers).

**Speed Ramping Feature:** Slowly increases speed for improved safety and enhanced coupling. Avoids splashing, improves spin bar control and provides excellent low end speed control (for stirrers or hotplate-stirrers).

**Optional Support Rod and Clamp Kit:** Kit includes 18" (45.7cm) stainless steel support rod, 3-prong medium swivel clamp, thermometer/temperature probe extension clamp, and hook connector. See page 74 for all options.

### Operating Conditions:

Unit can be run in conditions from 5 to 40°C (41 to 104°F), 20% to 80% relative humidity, non-condensing.

### Ordering Information:

Units include a 92" (234cm) detachable, 3-wire cord and plug (230 volt units are supplied with Euro type plug). Stirrers and Hotplate-Stirrers are supplied with a 1.5" (3.8cm) PTFE coated stir bar. **5 year limited warranty on parts and labor.**



984TA7CHSUSA

### Specifications

Top Plate Dimensions	
4 x 4" Units	4 x 4" (10.2 x 10.2cm)
7 x 7" Units	7 x 7" (17.8 x 17.8cm)
10 x 10" Units	10 x 10" (25.4 x 25.4cm)
Temperature Range	
Ceramic Top Plate Units	Ambient +5°C to 500°C
Aluminum Top Plate Units	Ambient +5°C to 400°C
Temperature Stability*	
Ceramic Top Plate Units	± 3%
Aluminum Top Plate Units	± 2%
Speed Range	60 to 1600rpm
Speed Stability	± 2%
Maximum Capacity (H <sub>2</sub> O)	
4 x 4" Units	600mL
7 x 7" Units	2500mL
10 x 10" Units	6000mL
Overall Dimensions (L x W x H)	
4 x 4" Units	10.8 x 6.6 x 4.3" (27.4 x 16.8 x 10.9cm)
7 x 7" Units	14.8 x 9.9 x 4.3" (37.6 x 25 x 10.9cm)
10 x 10" Units	17.9 x 13 x 4.3" (45.5 x 33 x 10.9cm)
Ship Weight	
4 x 4" Units	6.2lbs (2.8kg)
7 x 7" Units	10.5lbs (4.8kg)
10 x 10" Units	15.9lbs (7.2kg)

\* Below 100°C ± 2°C. Environmental and sample conditions permitting.

## Advanced Hotplates, Stirrers &amp; Hotplate-Stirrers

Advanced Hotplates			
Description	Top Plate Material	Electrical (50/60 Hz)	Part Number
4 x 4" (10.2 x 10.2cm) Hotplate	Ceramic	120V   2.9 amps   350 watts	984TA4CHPUSA
4 x 4" (10.2 x 10.2cm) Hotplate	Ceramic	230V   1.5 amps   350 watts	984TA4CHPEUA
4 x 4" (10.2 x 10.2cm) Hotplate	Aluminum	120V   2.9 amps   350 watts	984TA4AHPUSA
4 x 4" (10.2 x 10.2cm) Hotplate	Aluminum	230V   1.5 amps   350 watts	984TA4AHPEUA
7 x 7" (17.8 x 17.8cm) Hotplate	Ceramic	120V   7.9 amps   950 watts	984TA7CHPUSA
7 x 7" (17.8 x 17.8cm) Hotplate	Ceramic	230V   4.4 amps   1000 watts	984TA7CHPEUA
7 x 7" (17.8 x 17.8cm) Hotplate	Aluminum	120V   7.9 amps   950 watts	984TA7AHPUSA
7 x 7" (17.8 x 17.8cm) Hotplate	Aluminum	230V   4.4 amps   1000 watts	984TA7AHPEUA
10 x 10" (25.4 x 25.4cm) Hotplate	Ceramic	120V   12.5 amps   1500 watts	984TA0CHPUSA
10 x 10" (25.4 x 25.4cm) Hotplate	Ceramic	230V   6.7 amps   1550 watts	984TA0CHPEUA
10 x 10" (25.4 x 25.4cm) Hotplate	Aluminum	120V   12.5 amps   1550 watts	984TA0AHPUSA
10 x 10" (25.4 x 25.4cm) Hotplate	Aluminum	230V   6.7 amps   1550 watts	984TA0AHPEUA
Advanced Stirrers			
Description	Top Plate Material	Electrical (50/60 Hz)	Part Number
4 x 4" (10.2 x 10.2cm) Stirrer	Ceramic	120V   0.4 amps   50 watts	984TA4CSTUSS
4 x 4" (10.2 x 10.2cm) Stirrer	Ceramic	230V   0.2 amps   50 watts	984TA4CSTEUS
4 x 4" (10.2 x 10.2cm) Stirrer	Aluminum	120V   0.4 amps   50 watts	984TA4ASTUSS
4 x 4" (10.2 x 10.2cm) Stirrer	Aluminum	230V   0.2 amps   50 watts	984TA4ASTEUS
7 x 7" (17.8 x 17.8cm) Stirrer	Ceramic	120V   0.4 amps   50 watts	984TA7CSTUSS
7 x 7" (17.8 x 17.8cm) Stirrer	Ceramic	230V   0.2 amps   50 watts	984TA7CSTEUS
7 x 7" (17.8 x 17.8cm) Stirrer	Aluminum	120V   0.4 amps   50 watts	984TA7ASTUSS
7 x 7" (17.8 x 17.8cm) Stirrer	Aluminum	230V   0.2 amps   50 watts	984TA7ASTEUS
10 x 10" (25.4 x 25.4cm) Stirrer	Ceramic	120V   0.4 amps   50 watts	984TA0CSTUSS
10 x 10" (25.4 x 25.4cm) Stirrer	Ceramic	230V   0.2 amps   50 watts	984TA0CSTEUS
10 x 10" (25.4 x 25.4cm) Stirrer	Aluminum	120V   0.4 amps   50 watts	984TA0ASTUSS
10 x 10" (25.4 x 25.4cm) Stirrer	Aluminum	230V   0.2 amps   50 watts	984TA0ASTEUS
Advanced Hotplate-Stirrers			
Description	Top Plate Material	Electrical (50/60 Hz)	Part Number
4 x 4" (10.2 x 10.2cm) Hotplate-Stirrer	Ceramic	120V   3.3 amps   400 watts	984TA4CHSUSA
4 x 4" (10.2 x 10.2cm) Hotplate-Stirrer	Ceramic	230V   1.7 amps   400 watts	984TA4CHSEUA
4 x 4" (10.2 x 10.2cm) Hotplate-Stirrer	Aluminum	120V   3.3 amps   400 watts	984TA4AHSUSA
4 x 4" (10.2 x 10.2cm) Hotplate-Stirrer	Aluminum	230V   1.7 amps   400 watts	984TA4AHSEUA
7 x 7" (17.8 x 17.8cm) Hotplate-Stirrer	Ceramic	120V   8.3 amps   1000 watts	984TA7CHSUSA
7 x 7" (17.8 x 17.8cm) Hotplate-Stirrer	Ceramic	230V   4.6 amps   1050 watts	984TA7CHSEUA
7 x 7" (17.8 x 17.8cm) Hotplate-Stirrer	Aluminum	120V   8.3 amps   1000 watts	984TA7AHSUSA
7 x 7" (17.8 x 17.8cm) Hotplate-Stirrer	Aluminum	230V   4.6 amps   1050 watts	984TA7AHSEUA
10 x 10" (25.4 x 25.4cm) Hotplate-Stirrer	Ceramic	120V   12.9 amps   1550 watts	984TA0CHSUSA
10 x 10" (25.4 x 25.4cm) Hotplate-Stirrer	Ceramic	230V   7.0 amps   1600 watts	984TA0CHSEUA
10 x 10" (25.4 x 25.4cm) Hotplate-Stirrer	Aluminum	120V   12.9 amps   1550 watts	984TA0AHSUSA
10 x 10" (25.4 x 25.4cm) Hotplate-Stirrer	Aluminum	230V   7.0 amps   1600 watts	984TA0AHSEUA

- Excellent temperature uniformity
- Cool touch, chemical resistant housing
- Includes RTD temperature probe kit

Talboys Professional Round Top Hotplate-Stirrers are designed for applications that require exceptional accuracy, stability, and repeatability. Exclusive safety features help protect operator and sample. Enhanced microprocessor control offers an external RTD probe option that delivers superior temperature control of the sample. Stirring function, with continuous duty motor and powerful magnet, maintains set speed even under changing load or viscosity. Separate LED displays for temperature, speed, and time allow user to view all settings at once.

### Operating Features:

**Low Profile Design:** Takes up minimal space and fits easily into fume hoods. Spill-resistant design channels fluids away from internal components.

**Microprocessor Control:** Advanced electronics regulate both heating and stirring and bring samples to temperature quickly and efficiently. Temperature measurement is controlled more accurately by utilizing an internal RTD. Speed is precisely controlled, and provides consistent stirring at all speeds. Powerful continuous duty motor delivers dependable and reliable stirring.

**Control Panel:** Touch pad controls with easy-to-read, independent LED displays for temperature, speed, and time allow operator to view all settings at once. Provides repeatable and accurate results every time and is easily visible from outside fume hoods or across lab benches. Shows set-point and actual temperature. Timer will display elapsed time or, when programmed to user defined limit, will shut off unit when time reaches zero. Display will show last used settings, even after power has been turned off.

**Stainless Steel Top Plate:** 5.3" (135mm) diameter top plate is durable and will not crack. Accepts optional Talboys base plate that holds a variety of block options for holding multiple samples at one time.

**Built-in Support Rod Holder:** Rear housing features an off-centered, built-in support rod holder with locking knob that accepts the probe kit.

### Safety Features:

**Cool Touch Housing:** Housing is made of a heat resistant polymer that is not only cool to the touch, but is also chemical resistant.

**Hot Top Indicator:** For additional safety, hot symbol warning light is illuminated when heat is turned on and remains on until top plate cools down.

**Speed Ramping Feature:** Slowly increases speed for improved safety and enhanced coupling. Avoids splashing, improves spin bar control and provides excellent low end speed control.

**Maximum Temperature Limiting (Plate Over Temperature Limit):** Ensures plate temperature will never exceed users programmed set temperature limit, allowing for control of samples with sensitive flash points.

**Audible Alarm:** In timed mode, alarm will sound when time reaches zero or when unit reaches set-point temperature.

**Probe Protection:** If probe disengages from sample, unit will automatically shut off heater.



984TARSHSUSP

### Operating Conditions:

Unit can be run in conditions from 5 to 40°C (41 to 104°F), 20% to 80% relative humidity, non-condensing.

### Ordering Information:

Units include a 92" (234cm) detachable, 3-wire cord and plug (230V units are supplied with Euro type plug). Units are also supplied with a 1.5" (3.8cm) PTFE coated stir bar and RTD probe kit which includes a PT1000, 8" (20.3cm) stainless steel RTD temperature probe, 12" (30.5cm) flex arm and interchangeable 3-prong clamp head, 2-prong clamp head, and spring clamp head. **5 year limited warranty on parts and labor.**

**Optional NIST Traceable Calibration Certificate** provided by Troemner's ISO/IEC 17025 accredited laboratory. Multiple data points within the temperature and speed ranges, and time function, are reported on the certificate with the associated uncertainties.

Specifications	
Temperature Range	Ambient +5°C to 400°C
Temperature Stability*	± 1%
Speed Range	60 to 1600rpm
Speed Stability	± 2%
Maximum Capacity	1500mL
Top Plate Dimensions (Dia.)	5.3" (135mm)
Overall Dimensions (L x W x H)	14.8 x 9.9 x 4.3" (37.6 x 25.1 x 10.9cm)
Ship Weight	11.7lbs (5.3kg)

\* Below 100°C ± 1°C. Environmental and sample conditions permitting.

Description	Electrical (50/60 Hz)	Part Number
Professional Round Top Hotplate-Stirrer	120V   8.3 amps   500 watts	984TARSHSUSP
Professional Round Top Hotplate-Stirrer	230V   4.6 amps   500 watts	984TARSHSEUP
Professional Round Top Hotplate-Stirrer with NIST Traceable Certificate	120V   8.3 amps   500 watts	984TARSHSUSC
Professional Round Top Hotplate-Stirrer with NIST Traceable Certificate	230V   4.6 amps   500 watts	984TARSHSEUC

## Advanced Round Top Hotplate-Stirrers



- Excellent temperature uniformity
- Cool touch, chemical resistant housing
- LED display for temperature

Talboys Advanced Round Top Hotplate-Stirrers deliver accurate and repeatable results. These units are microprocessor controlled and have an LED display for temperature. Control panel features easy-to-use controls which allow users to dial in adjustments. Rear housing features an integral support rod holder with locking knob to accept the optional Support Rod and Clamp Kit.

**Operating Features:**

**Low Profile Design:** Takes up minimal space and fits easily into fume hoods. Spill-resistant design channels fluids away from internal components.

**LED Display:** Shows set-point temperature. Display is easy-to-read and provides repeatable and accurate results every time.

**Control Panel:** Adjustment knob for temperature displays set-point in LED display. Stir control knob has rpm adjustment markings.

**Recall Last Temperature:** Built-in memory allows users to recall last set temperature, even when unit has been turned off.

**Microprocessor Control:** Advanced electronics regulate both heating and stirring and bring samples to temperature quickly and efficiently. Temperature measurement is controlled more accurately by utilizing an internal RTD. Speed is precisely controlled, and provides consistent stirring at all speeds. Powerful continuous duty motor delivers dependable and reliable stirring.

**Heating Capacity:** Robust heater allows heating surface to reach set-point quickly.

**Stainless Steel Top Plate:** 5.3" (135mm) diameter top plate is durable and will not crack. Accepts optional Talboys base plate that holds a variety of block options for holding multiple samples at one time.

**Built-In Support Rod Holder:** Rear housing features an off-centered, built-in support rod holder with locking knob that accepts the optional Support Rod and Clamp Kit.

**Safety Features:**

**Cool Touch Housing:** Housing is made of a heat resistant polymer that is not only cool to the touch, but is also chemical resistant.

**Hot Top Indicator:** For additional safety, hot symbol warning light is illuminated when heat is turned on and remains on until top plate cools down.

**Speed Ramping Feature:** Slowly increases speed for improved safety and enhanced coupling. Avoids splashing, improves spin bar control, and provides excellent low end speed control.

**Optional Support Rod and Clamp Kit:** Kit includes 18" (45.7cm) stainless steel support rod, 3-prong medium swivel clamp, thermometer/temperature probe extension clamp, and hook connector. See page 74 for all options.



984TARSHSUSA

**Operating Conditions:**

Unit can be run in conditions from 5 to 40°C (41 to 104°F), 20% to 80% relative humidity, non-condensing.

**Ordering Information:**

Units include a 92" (234cm) detachable, 3-wire cord and plug (230V units are supplied with Euro type plug). Units are also supplied with a 1.5" (3.8cm) PTFE coated stir bar. **5 year limited warranty on parts and labor.**

**Specifications**

Temperature Range	Ambient +5° to 400°C
Temperature Stability*	± 3%
Speed Range	60 to 1600rpm
Speed Stability	± 2%
Maximum Capacity	1500mL
Top Plate Dimensions (Dia.)	5.3" (135mm)
Overall Dimensions (L x W x H)	14.8 x 9.9 x 4.3" (37.6 x 25.1 x 10.9cm)
Ship Weight	9.4lbs (4.3kg)

\* Below 100°C ± 2°C. Environmental and sample conditions permitting.

Description	Electrical (50/60 Hz)	Part Number
Advanced Round Top Hotplate-Stirrer	120V   8.3 amps   500 watts	984TARSHSUSA
Advanced Round Top Hotplate-Stirrer	230V   4.6 amps   500 watts	984TARSHSEUA

- Heat and stir a variety of samples simultaneously on one hotplate-stirrer
- Uni and sectional blocks accommodate 9 different sample sizes
- Anodized aluminum with close block to tube contact ensures optimal transfer of heat

The Talboys Multi-Sample Reaction Station enables you to heat and stir multiple samples of one size or up to five multiple sample blocks of different sizes, all with one unit. The base plate can hold 5 sectional blocks or one uni-block. For added versatility, the base plate has a centrally located threaded opening to accommodate a 1/2" (13mm) support rod. Both block styles are offered in 9 different sample size configurations for vials and test tubes. Blocks are made of anodized aluminum to provide superior temperature stability and heat transfer. Each block has a thermometer well for measuring block temperature. Base plate is designed to fit on the Talboys Professional or Advanced Round Top Hotplate-Stirrers or other 135mm diameter top models. Safety handles are available to aid in the safe removal of the base plate with blocks.

### Uni-Blocks

#### Test Tubes

Sample Type	No. of Wells	Well Dia.	Well Depth	Part Number
12mm Tube	40	12.7mm	45.7mm;	984TAM12MMT
16mm Tube	32	17.5mm	45.7mm	984TAM16MMT
20mm Tube	32	20.5mm	45.7mm	984TAM20MMT
25mm Tube	24	25.4mm	41.9mm	984TAM25MMT

#### Vials

Sample Type	No. of Wells	Well Dia.	Well Depth	Part Number
12mm Vial (2mL)	40	12.7mm	16.8mm	984TAM12MMV
15mm Vial (1 dram)	40	15.5mm	16.8mm	984TAM15MMV
17mm Vial (2 dram)	32	17.8mm	16.8mm	984TAM17MMV
21mm Vial (4 dram)	24	21.5mm	16.8mm	984TAM21MMV
28mm Vial	16	28.8mm	16.8mm	984TAM28MMV

### Sectional Blocks

#### Test Tubes

Sample Type	No. of Wells	Well Dia.	Well Depth	Part Number
12mm Tube	9	12.7mm	45.7mm	984TAP12MMT
16mm Tube	8	17.5mm	45.7mm	984TAP16MMT
20mm Tube	6	20.5mm	45.7mm	984TAP20MMT
25mm Tube	5	25.4mm	41.9mm	984TAP25MMT

#### Vials

Sample Type	No. of Wells	Well Dia.	Well Depth	Part Number
12mm Vial (2mL)	9	12.7mm	16.8mm	984TAP12MMV
15mm Vial (1 dram)	10	15.5mm	16.8mm	984TAP15MMV
17mm Vial (2 dram)	7	17.8mm	16.8mm	984TAP17MMV
21mm Vial (4 dram)	5	21.5mm	16.8mm	984TAP21MMV
28mm Vial	3	28.8mm	16.8mm	984TAP28MMV

### Other Accessories

Description	Part Number
Base plate for 135mm diameter plates	984TABASEPLT
Safety Handles (2)	984TAHANDLES



## Basic Mini Hotplates, Stirrers &amp; Hotplate-Stirrers



- Hotplates & Hotplate-Stirrers boil 300mL of water in 12 minutes
- Ideal for educational labs
- Built in support rod holder

Talboys Basic Mini Hotplates, Stirrers, and Hotplate-Stirrers are rugged, compact units that heat and stir up to 1000mL of liquid. Durable, cast aluminum top plate will not crack or chip, and provides an even heating surface. Bi-metallic thermostat offers reliable temperature control. Powerful heater reaches maximum temperature in only minutes. Powerful motor and magnet deliver reliable and consistent stirring. Compact design saves bench space. Built-in support rod holder with locking knob accepts optional Support Rod and Clamp Kit.

Basic Mini Fixed Temperature Hotplate features an illuminated rocker switch to activate the preset fixed temperature of 400°C.

Basic Mini Auto-Stirrer is automatically activated by the minimum weight of a beaker or flask and will stop stirring when mixing vessel is removed.

#### Operating Features:

**Adjustment Knobs:** Basic speed and temperature control knobs with dial markings from 1 to 10.

#### Operating Conditions:

Units can be run in conditions from 5 to 40°C (41 to 104°F), 20% to 85% relative humidity, non-condensing.

#### Applications:

Academia and Basic chemistry.

#### Ordering Information:

Units include a 72" (183cm), 3-wire cord and plug (230 volt units are supplied with Euro type plug). Stirrers and Hotplate-Stirrers are supplied with a 1.5" (3.8cm) PTFE coated stir bar. Additional stir bars are available for stirring models on page 74. **5 year limited warranty on parts and labor.**



953202

Specifications	
Temperature Range	to 400°C*
Speed Range	100 to 1200rpm
Maximum Capacity (H <sub>2</sub> O)	1000mL
Top Plate Dimensions (Dia.)	4.5" (11.4cm)
Overall Dimensions (L x W x H)	6.5 x 5.8 x 5.3" (16.5 x 14.7 x 13.5cm)
Ship Weight	4.5lbs (2kg)

\* Fixed Temperature Hotplate has a fixed temperature of 400°C.

#### Basic Mini Hotplates

Description	Electrical (50/60 Hz)	Part Number
Basic Mini Hotplate	120V   6.0 amps   565 watts	953201
Basic Mini Hotplate	230V   2.5 amps   430 watts	953205
Basic Mini Fixed Temperature Hotplate	120V   6.0 amps   565 watts	953203
Basic Mini Fixed Temperature Hotplate	230V   2.5 amps   430 watts	953208

#### Basic Mini Stirrers

Description	Electrical (50/60 Hz)	Part Number
Basic Mini Stirrer	120V   0.5 amps   20 watts	953200
Basic Mini Stirrer	230V   0.25 amps   20 watts	953204
Basic Mini Auto-Stirrer	120V   0.5 amps   20 watts	953207

#### Basic Mini Hotplate-Stirrers

Description	Electrical (50/60 Hz)	Part Number
Basic Mini Hotplate-Stirrer	120V   6.0 amps   565 watts	953202
Basic Mini Hotplate-Stirrer	230V   2.5 amps   430 watts	953206

- Powerful motor and magnet mix up to 25L of liquid
- Large top plate surface
- Microprocessor controls

Talboys Standard and Advanced High Volume Stirrers are designed for large capacity applications. Powerful magnet and motor offer exceptional magnetic coupling force capable of stirring 25L.

### Operating Features:

**Low Profile Design:** Takes up minimal space. Spill-resistant housing channels fluids away from internal components. Cast aluminum base offers durability and added stability.

**Glass Filled Nylon Top Plate:** Features a chemical resistant, reflective white top plate surface that is easy to clean.

**Large Top Plate:** Accommodates oversized vessels.

**Microprocessor Control:** Precisely regulates speed through the entire range. Stirring function, with continuous duty motor and magnet, maintains set speed even under changing load or viscosity.

**Adjustment Knob:** Basic speed control knob with dial markings from 1 to 10 (Standard Series).

**LED Display:** Touch pad controls with easy-to-read, independent LED displays for speed and time. Speed is adjustable in 10rpm increments. Timer will display elapsed time or, when programmed to user defined limit, will shut off unit when time reaches zero (Advanced Series).

### Safety Features:

**Audible Alarm:** In timed mode, alarm will sound when time reaches zero (Advanced Series).

**Speed Ramping Feature:** Slowly increases speed for improved safety and enhanced coupling. Avoids splashing, improves spin bar control and provides excellent low speed control.

### Operating Conditions:

Units can be run in conditions from 5 to 40°C (41 to 104°F), 20% to 80% relative humidity, non-condensing.

### Applications:

Carboys, chromatography, and large volume sample stirring.

### Ordering Information:

Units include a 92" (234cm) detachable, 3-wire cord and plug (230 volt units are supplied with Euro type plug). Units are also supplied with a 2.75" (7cm) PTFE coated stir bar. Additional stir bars are available on page 74. **5 year limited warranty on parts and labor.**

**Optional NIST Traceable Calibration Certificate** provided by Troemner's ISO/IEC 17025 accredited laboratory. Multiple data points within the speed range and time function are reported on the certificate with the associated uncertainties.



Specifications	
Speed Range	60 to 1400rpm
Speed Stability	60 to 250rpm +/-5rpm 250 to 1400rpm +/-2%
Timer (Advanced Series)	1 second to 160 hours
Maximum Capacity (H <sub>2</sub> O)	25L
Maximum Vessel Diameter	10" (25cm)
Top Plate Material	Glass filled nylon
Top Plate Dimensions (L x W)	12.5 x 11" (31.8 x 27.9cm)
Overall Dimensions (L x W x H)	17 x 11 x 4" (43.2 x 27.9 x 9.7cm)
Ship Weight	14.6lbs (6.6kg)

Description	Electrical (50/60 Hz)	Positions	Part Number
Standard High Volume Stirrer	120V   1.3 amps   75 watts	1	986366
Standard High Volume Stirrer	230V   0.65 amps   75 watts	1	986367
Advanced High Volume Stirrer	120V   1.3 amps   75 watts	1	986368
Advanced High Volume Stirrer	230V   0.65 amps   75 watts	1	986369
Advanced High Volume Stirrer with NIST Traceable Certificate	120V   1.3 amps   75 watts	1	986368-C
Advanced High Volume Stirrer with NIST Traceable Certificate	230V   0.65 amps   75 watts	1	986369-C



## Advanced Large Capacity Stirrers



- LED Displays for speed and time
- Durable, stainless steel construction
- Mixes up to 200L

Talboys Advanced Model 1000 and Model 2000 Large Capacity Stirrers are ideal for high volume applications. The powerful magnetic drive is capable of mixing high viscosity materials. Stainless steel base offers durability and added stability.

**Operating Features:**

**Microprocessor Control:** Precisely regulates speed through the entire range. Stirring function, with continuous duty motor and magnet, maintains set speed even under changing load or viscosity.

**LED Display:** Touch pad controls with easy-to-read, independent LED displays for speed and time. Timer will display elapsed time or, when programmed to user defined limit, will shut off unit when time reaches zero.

**Safety Features:**

**Audible Alarm:** In timed mode, alarm will sound when time reaches zero.

**Speed Ramping Feature:** Slowly increases speed for improved safety and enhanced coupling. Avoids splashing, improves spin bar control and provides excellent low speed control.

**Operating Conditions:**

Units can be run in conditions from 5 to 40°C (41 to 104°F), 20% to 80% relative humidity, non-condensing.

**Applications:**

Mixing viscous materials, polymers, and pilot scale.

**Ordering Information:**

Units include a 92" (234cm) detachable, 3-wire cord and plug (230 volt units are supplied with Euro type plug). Model 1000 units are supplied with a 2.75" (7cm) egg shaped PTFE coated stir bar, Model 2000 units are supplied with a 4" (10.2cm) PTFE coated stir bar with a pivot ring. Additional stir bars are available on page 74. **5 year limited warranty on parts and labor.**

**Optional NIST Traceable Calibration Certificate** provided by Troemner's ISO/IEC 17025 accredited laboratory. Multiple data points within the speed range and time function are reported on the certificate with the associated uncertainties.



986370

Specifications	
Speed Range	100 to 1800rpm (increased in 10 rpm increments)
Speed Stability	± 2%
Timer	1 second to 160 hours
Maximum Capacity (H <sub>2</sub> O)	
Model 1000	100L
Model 2000	200L
Maximum Weight Capacity	425lbs (193kg)
Top Plate Material	304 stainless steel
Top Plate Dimensions (L x W)	21.25 x 25" (54 x 53.5cm)
Overall Dimensions (L x W x H)	28.5 x 26.75 x 5.25" (72.4 x 68 x 13.3cm)
Ship Weight	71lbs (32.2kg)

Description	Electrical (50/60 Hz)	Part Number
Advanced Model 1000 Large Capacity Stirrer, 100L	120V   1.0 amps   41 watts	986370
Advanced Model 1000 Large Capacity Stirrer, 100L	230V   0.5 amps   41 watts	986371
Advanced Model 2000 Large Capacity Stirrer, 200L	120V   1.0 amps   82 watts	986372
Advanced Model 2000 Large Capacity Stirrer, 200L	230V   0.5 amps   82 watts	986373
Advanced Model 1000 Large Capacity Stirrer, 100L with NIST Traceable Certificate	120V   1.0 amps   41 watts	986370-C
Advanced Model 1000 Large Capacity Stirrer, 100L with NIST Traceable Certificate	230V   0.5 amps   41 watts	986371-C
Advanced Model 2000 Large Capacity Stirrer, 200L with NIST Traceable Certificate	120V   1.0 amps   82 watts	986372-C
Advanced Model 2000 Large Capacity Stirrer, 200L with NIST Traceable Certificate	230V   0.5 amps   82 watts	986373-C

- Stirs up to 9 vessels at once
- Synchronized and uniform mixing
- Low profile design

Talboys Standard and Advanced Multi-Position Stirrers are powerful magnetic stirrers with precise speed control that offer repeatable performance. Synchronized operation ensures uniform mixing at each position.

### Operating Features:

**Low Profile Design:** Takes up minimal space. Spill-resistant housing channels fluids away from internal components. Cast aluminum base offers durability and added stability.

**Glass Filled Nylon Top Plate:** Features a chemical resistant, reflective white top plate surface that is easy to clean.

**Large Top Plate:** Stirs up to 9 vessels at once with helpful position indicators.

**Microprocessor Control:** Precisely regulates speed through the entire range. Stirring function, with continuous duty motor and magnet, maintains set speed even under changing load or viscosity.

**Adjustment Knob:** Basic speed control knob with dial markings from 1 to 10 (Standard Series).

**LED Display:** Touch pad controls with easy-to-read, independent LED displays for speed and time. Speed is adjustable in 10rpm increments. Timer will display elapsed time or, when programmed to user defined limit, will shut off unit when time reaches zero (Advanced Series).

### Safety Features:

**Speed Ramping Feature:** Slowly increases speed for improved safety and enhanced coupling. Avoids splashing, improves spin bar control and provides excellent low speed control.

**Audible Alarm:** In timed mode, alarm will sound when time reaches zero (Advanced Series).

### Operating Conditions:

Units can be run in conditions from 5 to 40°C (41 to 104°F), 20% to 80% relative humidity, non-condensing.

### Applications:

Dissolution studies, media/reagent preparations, and titration studies.

### Ordering Information:

Units include a 92" (234cm) detachable, 3-wire cord and plug (230 volt units are supplied with Euro type plug). Units are also supplied with a 1" (2.5cm) PTFE coated stir bar for each position. Additional stir bars are available on page 74. **5 year limited warranty on parts and labor.**

**Optional NIST Traceable Calibration Certificate** provided by Troemner's ISO/IEC 17025 accredited laboratory. Multiple data points within the speed range and time function are reported on the certificate with the associated uncertainties.

986350



986364



### Specifications

Speed Range	60 to 1400rpm
Speed Stability	60 to 250rpm +/-5rpm 250 to 1400rpm +/-2%
Timer (Advanced Series)	1 second to 160 hours
Top Plate Material	Glass filled nylon
Top Plate Dimensions (L x W)	12.5 x 11" (31.8 x 27.9cm)
Overall Dimensions (L x W x H)	17 x 11 x 4" (43.2 x 27.9 x 9.7cm)
Ship Weight	14.75lbs (6.7kg)

## Standard &amp; Advanced Multi-Position Stirrers

## Standard Multi-Position Stirrers

Description	Electrical (50/60 Hz)	Positions	Maximum Capacity H <sub>2</sub> O*	Maximum Vessel Diameter	Part Number
Standard Multi-Position Stirrer 4	120V   1.3 amps   75 watts	4	1L	5.1" (13cm)	986350
Standard Multi-Position Stirrer 4	230V   0.65 amps   75 watts	4	1L	5.1" (13cm)	986351
Standard Multi-Position Stirrer 5	120V   1.3 amps   75 watts	5	600mL	3.75" (9.5cm)	986354
Standard Multi-Position Stirrer 5	230V   0.65 amps   75 watts	5	600mL	3.75" (9.5cm)	986355
Standard Multi-Position Stirrer 6	120V   1.3 amps   75 watts	6	400mL	3.2" (8cm)	986358
Standard Multi-Position Stirrer 6	230V   0.65 amps   75 watts	6	400mL	3.2" (8cm)	986359
Standard Multi-Position Stirrer 9	120V   1.3 amps   75 watts	9	250mL	3" (7.5cm)	986362
Standard Multi-Position Stirrer 9	230V   0.65 amps   75 watts	9	250mL	3" (7.5cm)	986363

## Advanced Multi-Position Stirrers

Description	Electrical (50/60 Hz)	Positions	Maximum Capacity H <sub>2</sub> O*	Maximum Vessel Diameter	Part Number
Advanced Multi-Position Stirrer 4	120V   1.3 amps   75 watts	4	1L	5.1" (13cm)	986352
Advanced Multi-Position Stirrer 4	230V   0.65 amps   75 watts	4	1L	5.1" (13cm)	986353
Advanced Multi-Position Stirrer 5	120V   1.3 amps   75 watts	5	600mL	3.75" (9.5cm)	986356
Advanced Multi-Position Stirrer 5	230V   0.65 amps   75 watts	5	600mL	3.75" (9.5cm)	986357
Advanced Multi-Position Stirrer 6	120V   1.3 amps   75 watts	6	400mL	3.2" (8cm)	986360
Advanced Multi-Position Stirrer 6	230V   0.65 amps   75 watts	6	400mL	3.2" (8cm)	986361
Advanced Multi-Position Stirrer 9	120V   1.3 amps   75 watts	9	250mL	3" (7.5cm)	986364
Advanced Multi-Position Stirrer 9	230V   0.65 amps   75 watts	9	250mL	3" (7.5cm)	986365
Advanced Multi-Position Stirrer 4 with NIST Traceable Certificate	120V   1.3 amps   75 watts	4	1L	5.1" (13cm)	986352-C
Advanced Multi-Position Stirrer 4 with NIST Traceable Certificate	230V   0.65 amps   75 watts	4	1L	5.1" (13cm)	986353-C
Advanced Multi-Position Stirrer 5 with NIST Traceable Certificate	120V   1.3 amps   75 watts	5	600mL	3.75" (9.5cm)	986356-C
Advanced Multi-Position Stirrer 5 with NIST Traceable Certificate	230V   0.65 amps   75 watts	5	600mL	3.75" (9.5cm)	986357-C
Advanced Multi-Position Stirrer 6 with NIST Traceable Certificate	120V   1.3 amps   75 watts	6	400mL	3.2" (8cm)	986360-C
Advanced Multi-Position Stirrer 6 with NIST Traceable Certificate	230V   0.65 amps   75 watts	6	400mL	3.2" (8cm)	986361-C
Advanced Multi-Position Stirrer 9 with NIST Traceable Certificate	120V   1.3 amps   75 watts	9	250mL	3" (7.5cm)	986364-C
Advanced Multi-Position Stirrer 9 with NIST Traceable Certificate	230V   0.65 amps   75 watts	9	250mL	3" (7.5cm)	986365-C

\* Maximum capacity per position

- Ideal for cell culture applications
- Slow start/stop feature
- Efficient drive motor eliminates heat transfer to sample

Talboys Standard and Advanced Slow Speed Stirrers are designed for growth of suspension and micro-carrier cell cultures. Slow Speed Stirrers work with cell culture flasks and other vessels designed for slow magnetic stirring. Ideal for use in cold rooms, incubator, or CO<sub>2</sub> incubators (-10°C to 40°C), 20% to 80% relative humidity, non condensing environment.

### Operating Features:

**Low Profile Design:** Takes up minimal space and easily fits into fume hoods and most incubators. Spill-resistant housing channels fluids away from internal components. Cast aluminum base offers durability and added stability.

**Glass Filled Nylon Top Plate:** Features a chemical resistant, reflective white top plate surface that is easy to clean (4 position and 10L models).

**Aluminum Top Plate:** Durable aluminum top will not crack or chip. (1 position models)

**Large Top Plate:** Stirs up to 4 vessels at once with helpful position indicators.

**Microprocessor Control:** Precisely regulates speed through the entire range. Stirring function, with continuous duty motor and magnet, maintains set speed even under changing load or viscosity.

**Adjustment Knob:** Basic speed control knob with dial markings from 1 to 10 (Standard Series).

**LED Display:** Touch pad controls with easy-to-read, independent LED displays for speed and time. Speed is adjustable in 1rpm increments. Timer will display elapsed time or, when programmed to user defined limit, will shut off unit when time reaches zero (Advanced Series).

### Safety Features:

**Speed Ramping Feature:** Slowly increases speed for improved safety and enhanced coupling. Avoids splashing, improves spin bar control and provides excellent low speed control.

**Audible Alarm:** In timed mode, alarm will sound when time reaches zero (Advanced Series).

### Operating Conditions:

Units can be run in cold rooms, incubators, and CO<sub>2</sub> environments from -10 to 40°C (14 to 104°F), 20% to 80% relative humidity, non-condensing.

### Applications:

Uniform suspensions of cell cultures, hybridomas, or any slow controlled stirring.

### Ordering Information:

Units include a 92" (234cm) detachable, 3-wire cord and plug (230 volt units are supplied with Euro type plug). **5 year limited warranty on parts and labor.**

**Optional NIST Traceable Calibration Certificate** provided by Troemner's ISO/IEC 17025 accredited laboratory. Multiple data points within the speed range and time function are reported on the certificate with the associated uncertainties.



986374



986382

### Specifications

Speed Range	1 to 150rpm
Timer (Advanced Series)	1 second to 160 hours
Top Plate Material	Glass filled nylon
4 Position / 10L	Aluminum
1 Position	
Top Plate Dimensions (L x W)	
4 Position / 10L	12.5 x 11" (31.8 x 27.9cm)
1 Position	7 x 7" (17.8 x 17.8cm)
Overall Dimensions (L x W x H)	
4 Position / 10L	17 x 11 x 4" (43.2 x 27.9 x 10.2cm)
1 Position	12.1 x 8.5 x 4" (30.7 x 21.6 x 9.9cm)
Ship Weight	
4 Position / 10L	14.5lbs (6.6kg)
1 Position	8.8lbs (4kg)

## Standard &amp; Advanced Slow Speed Stirrers

## Standard Slow-Speed Stirrers

Description	Electrical (50/60 Hz)	Positions	Maximum Capacity H <sub>2</sub> O*	Maximum Vessel Diameter	Part Number
Standard Slow Speed Stirrer 1	120V   0.14 amps   7.2 watts	1	2L	5.9" (15cm)	986374
Standard Slow Speed Stirrer 1	230V   0.14 amps   14.4 watts	1	2L	5.9" (15cm)	986375
Standard Slow Speed Stirrer 4	120V   0.14 amps   7.2 watts	4	1L	5.1" (13cm)	986380
Standard Slow Speed Stirrer 4	230V   0.14 amps   14.4 watts	4	1L	5.1" (13cm)	986381

## Advanced Slow-Speed Stirrers

Description	Electrical (50/60 Hz)	Positions	Maximum Capacity H <sub>2</sub> O*	Maximum Vessel Diameter	Part Number
Advanced Slow Speed Stirrer 1	120V   0.14 amps   7.2 watts	1	2L	5.9" (15cm)	986376
Advanced Slow Speed Stirrer 1	230V   0.14 amps   14.4 watts	1	2L	5.9" (15cm)	986377
Advanced Slow Speed Stirrer 4	120V   0.14 amps   7.2 watts	4	1L	5.1" (13cm)	986382
Advanced Slow Speed Stirrer 4	230V   0.14 amps   14.4 watts	4	1L	5.1" (13cm)	986383
Advanced Slow Speed Stirrer 10L	120V   0.14 amps   7.2 watts	1	10L	9.8" (25cm)	986378
Advanced Slow Speed Stirrer 10L	230V   0.14 amps   14.4 watts	1	10L	9.8" (25cm)	986379
Advanced Slow Speed Stirrer 1 with NIST Traceable Certificate	120V   0.14 amps   7.2 watts	1	2L	5.9" (15cm)	986376-C
Advanced Slow Speed Stirrer 1 with NIST Traceable Certificate	230V   0.14 amps   14.4 watts	1	2L	5.9" (15cm)	986377-C
Advanced Slow Speed Stirrer 4 with NIST Traceable Certificate	120V   0.14 amps   7.2 watts	4	1L	5.1" (13cm)	986382-C
Advanced Slow Speed Stirrer 4 with NIST Traceable Certificate	230V   0.14 amps   14.4 watts	4	1L	5.1" (13cm)	986383-C
Advanced Slow Speed Stirrer 10L with NIST Traceable Certificate	120V   0.14 amps   7.2 watts	1	10L	9.8" (25cm)	986378-C
Advanced Slow Speed Stirrer 10L with NIST Traceable Certificate	230V   0.14 amps   14.4 watts	1	10L	9.8" (25cm)	986379-C

\* Maximum capacity per position



- Mixes up to 1500mL of water; easily stirs 100% glycerol at 20°C
- Safe, low voltage DC operation
- Electronic speed control

Compact, submersible magnetic stirrer is housed in a sealed, nickel-plated brass case mounted on a solid brass base. A 38" (96.5cm) cable connects the power supply to the stirring unit. Stirrer operates on low voltage DC and is safely fused on DC side for safe operation underwater. Unit is easily mounted to rod supports or laboratory frames with standard mounting bracket on rear of power supply. Can also be used as a mini-stirrer in lattice work.

### Ordering Information:

Unit is supplied with a 1.5" (3.8cm) PTFE coated stir bar. **5 year limited warranty on parts and labor.**



952021

Specifications	
Speed Range	60 to 2000rpm
Maximum Capacity	1500mL
Power	20 watts
Dimensions, Stirrer (Dia. x H)	2.75 x 2.75" (7 x 7cm)
Dimensions, Power Supply (L x W x H)	5 x 4 x 3.5" (12.7 x 10.2 x 8.9cm)
Ship Weight	2lbs (0.9kg)

Description	Electrical (50/60 Hz)	Part Number
Submersible Stirrer-Model 700	120V   0.16 amps   20 watts	952021

## HOTPLATE-STIRRER ACCESSORIES

### Stir Bars - PTFE coated

Description	Size	Recommended for Unit	Part Number
Stir bar	1" (2.5cm)	Multi-Position Stirrers	985670
Stir bar	1.5" (3.8cm)	Basic Stirrers, Hotplate-Stirrers, Professional & Advanced Stirrers, Hotplate-Stirrers	985671
Stir bar (egg shaped)	2.75" (7cm)	High Volume Stirrers, Model 1000 Large Capacity Stirrer	985672
Stir bar with pivot ring	4" (10.2cm)	Model 2000 Large Capacity Stirrer	985673
Replacement pivot ring for 4" (10.2cm) stir bar			985674

### Temperature Probes

Description	Part Number
8" (20.3 cm) Stainless Steel Probe	984TA8SPROBE
8" (20.3 cm) PTFE Probe	984TA8PPROBE
10" (25.4 cm) Stainless Steel Probe	984TA10SPROB
10" (25.4 cm) PTFE Probe	984TA10PPROB
Replacement Probe Kit with 8" (20.3cm) Stainless Steel Probe	984TAPROBKIT

## Supports

**Ultra Flex Support Kit**

Extremely versatile with a unique flex arm that can be placed in virtually every position or angle. Includes 12" (30.5cm) flex arm and interchangeable 3-prong clamp head, 2-prong clamp head and spring clamp head.

Recommended for all Hotplates or Hotplate-Stirrers.

Description	Part Number
Ultra Flex Support Kit	985797

Ultra Flex Support Kit Includes:



3-Prong Clamp Head



2-Prong Clamp Head



Spring Clamp Head

**Support Rod and Clamp Kit**

Designed for holding temperature probes, thermometers or other glass tubes. Includes an 18" (45.7cm) stainless steel support rod, thermometer/temperature probe extension clamp, 3-prong medium swivel clamp, and hook connector.

Recommended for all Hotplates or Hotplate-Stirrers.

Description	Part Number
Support Rod and Clamp Kit	985690

Support Rod and Clamp Kit Includes:



Extension Clamp



3-Prong Swivel Clamp



Hook Connector

**Support Plates**

Designed to hold Hotplates/Stirrers and other apparatus to lab-frames or ring stands. Aluminum construction offers strength and durability. Support plates include a non-skid rubber mat and can mount to vertical rods up to 0.75" (1.9cm) in diameter.

**Small Support Plate** recommended for Advanced 4 x 4 or Basic Hotplates, Stirrers or Hotplate-Stirrers.

**Medium Support Plate** recommended for Professional or Advanced 7 x 7 Hotplates, Stirrers or Hotplate-Stirrers.

**Large Support Plate** recommended for multiple units.

Size	Dimensions	Part Number
Small	9.5 x 6.5" (24.1 x 16.5cm)	916299
Medium	12.75 x 9.0" (32.4 x 22.9cm)	916300
Large	15.75 x 12.0" (40 x 30.5cm)	916302









89

- Exceptional temperature uniformity and stability
- Optional external temperature probe
- Holds interchangeable modular blocks

Designed for applications that require repeatable results and superior temperature stability. These multi-purpose units are ideal for incubation and activation of cultures, enzyme reactions, immunoassays, melting/boiling points, and a wide variety of other laboratory procedures. Integral support rod holder with locking knob accepts optional External Temperature Probe Kit. Optional External Temperature Probe Kit monitors actual block or sample temperature. Each of the five models accepts separate interchangeable modular blocks, accommodating various tube sizes from 0.2mL micro-tubes to 50mL centrifuge tubes. Each block has a thermometer well for measuring block temperature. Efficient heating due to close tube-and-block contact for maximum heat retention. Heaters require Talboys modular heating blocks for operation. Modular blocks are sold separately (see pages 83–85).

#### Operating Features:

**Microprocessor Control:** PID temperature control, with optional external RTD probe, offers a temperature stability as low as  $\pm 0.1^\circ\text{C}$  with a temperature uniformity as low as  $\pm 0.1^\circ\text{C}$ . Samples are heated to temperature quickly and accurately. Temperature is adjusted in  $\pm 0.1^\circ\text{C}$  increments.

**LED Display:** Touch pad controls with easy-to-read, independent LED displays for temperature, and time. Provides repeatable and accurate results every time and is easily visible across lab benches. Shows set-point and actual temperature. Timer will display elapsed time or, when programmed to user defined limit, will shut off unit when time reaches zero. Display will show last used settings, even after power has been turned off.

**Temperature Calibration Mode:** Allows user to calibrate unit to an external temperature device.

#### Safety Features:

**Caution Hot Indicator:** Hot warning symbol light is illuminated when the temperature is above  $40^\circ\text{C}$ .

**Overshoot Protection:** If the unit exceeds the set temperature by  $10^\circ\text{C}$  the unit will automatically stop heating.

**Audible Alarm:** In timed mode, alarm will sound when time reaches zero and when unit reaches set-point temperature.

**CAUTION!** To avoid possible electrical hazard, do not fill well or block opening with water or other fluids. Unit is designed as a dry bath/incubator.

#### Operating Conditions:

Units can be run in conditions from 18 to  $33^\circ\text{C}$  ( $64$  to  $91^\circ\text{F}$ ), 20% to 80% relative humidity, non-condensing.

#### Applications:

Denaturing proteins, DNA applications, ELISA and other immunoassay studies.



#### Ordering Information:

Units include a 92" (234cm) detachable, 3-wire cord and plug (230 volt units are supplied with Euro type plug). Modular blocks are sold separately (see pages 83-85). **5 year limited warranty on parts and labor.**

**Optional NIST Traceable Calibration Certificate** provided by Troemner's ISO/IEC 17025 accredited laboratory. Multiple data points within the temperature range and time function are reported on the certificate with the associated uncertainties.

Size	Temperature Range	Temperature Stability @ $37^\circ\text{C}$	Uniformity Within the Block @ $37^\circ\text{C}$	Uniformity Across Similar Blocks @ $37^\circ\text{C}$	Heat-Up Time to $100^\circ\text{C}$
1 block	Ambient $+5^\circ\text{C}$ to $120^\circ\text{C}$	120 volt units: $\pm 0.1^\circ\text{C}$	120 volt units: $\pm 0.1^\circ\text{C}$	N/A	45 minutes
2 block				$\pm 0.1^\circ\text{C}$	50 minutes
3 block				$\pm 0.15^\circ\text{C}$	55 minutes
4 block				$\pm 0.2^\circ\text{C}$	60 minutes
6 block				$\pm 0.3^\circ\text{C}$	65 minutes

Advanced Dry Block Heaters

Advanced Dry Block Heaters				
Block Capacity	Dimensions (L x W x H)	Electrical (50/60 Hz)	Ship Weight	Part Number
1	12.4 x 8 x 3.5" (31.5 x 20.3 x 8.9cm)	120V   0.9 amps   110 watts	5.8lbs (2.6kg)	949500
1	12.4 x 8 x 3.5" (31.5 x 20.3 x 8.9cm)	230V   0.5 amps   110 watts	5.8lbs (2.6kg)	949501
2	15.4 x 8 x 3.5" (39.1 x 20.3 x 8.9cm)	120V   1.7 amps   210 watts	6.4lbs (2.9kg)	949502
2	15.4 x 8 x 3.5" (39.1 x 20.3 x 8.9cm)	230V   0.9 amps   210 watts	6.4lbs (2.9kg)	949503
3	18.4 x 8 x 3.5" (46.7 x 20.3 x 8.9cm)	120V   1.7 amps   210 watts	8.0lbs (3.6kg)	949504
3	18.4 x 8 x 3.5" (46.7 x 20.3 x 8.9cm)	230V   0.9 amps   210 watts	8.0lbs (3.6kg)	949505
4	16.9 x 8 x 3.5" (42.9 x 20.3 x 8.9cm)	120V   2.6 amps   310 watts	8.5lbs (3.9kg)	949506
4	16.9 x 8 x 3.5" (42.9 x 20.3 x 8.9cm)	230V   1.3 amps   310 watts	8.5lbs (3.9kg)	949507
6	20.9 x 8 x 3.5" (53.1 x 20.3 x 8.9cm)	120V   3.4 amps   410 watts	10.0lbs (4.5kg)	949508
6	20.9 x 8 x 3.5" (53.1 x 20.3 x 8.9cm)	230V   1.7 amps   410 watts	10.0lbs (4.5kg)	949509

Advanced Dry Block Heaters with NIST Traceable Certificate				
Block Capacity	Dimensions (L x W x H)	Electrical (50/60 Hz)	Ship Weight	Part Number
1	12.4 x 8 x 3.5" (31.5 x 20.3 x 8.9cm)	120V   0.9 amps   110 watts	5.8lbs (2.6kg)	949700
1	12.4 x 8 x 3.5" (31.5 x 20.3 x 8.9cm)	230V   0.5 amps   110 watts	5.8lbs (2.6kg)	949701
2	15.4 x 8 x 3.5" (39.1 x 20.3 x 8.9cm)	120V   1.7 amps   210 watts	6.4lbs (2.9kg)	949702
2	15.4 x 8 x 3.5" (39.1 x 20.3 x 8.9cm)	230V   0.9 amps   210 watts	6.4lbs (2.9kg)	949703
3	18.4 x 8 x 3.5" (46.7 x 20.3 x 8.9cm)	120V   1.7 amps   210 watts	8.0lbs (3.6kg)	949704
3	18.4 x 8 x 3.5" (46.7 x 20.3 x 8.9cm)	230V   0.9 amps   210 watts	8.0lbs (3.6kg)	949705
4	16.9 x 8 x 3.5" (42.9 x 20.3 x 8.9cm)	120V   2.6 amps   310 watts	8.5lbs (3.9kg)	949706
4	16.9 x 8 x 3.5" (42.9 x 20.3 x 8.9cm)	230V   1.3 amps   310 watts	8.5lbs (3.9kg)	949707
6	20.9 x 8 x 3.5" (53.1 x 20.3 x 8.9cm)	120V   3.4 amps   410 watts	10.0lbs (4.5kg)	949708
6	20.9 x 8 x 3.5" (53.1 x 20.3 x 8.9cm)	230V   1.7 amps   410 watts	10.0lbs (4.5kg)	949709

External Temperature Probe Kit

Enables the unit to read actual block or sample temperature and display that temperature on the control panel. The optional External Temperature Probe Kit includes a stainless steel RTD PT100 probe, 18" (45.7cm) stainless steel support rod, thermometer/temperature probe extension clamp and hook connector. The PT100 RTD probe is designed to fit perfectly in to the thermometer well of each modular block.



Description	Part Number
Optional External Temperature Probe Kit	949520

## Standard Dry Block Heaters

- Multi-purpose use
- Holds interchangeable modular blocks
- Analog controls

High wattage, constant-temperature Dry Block Heaters are economical, versatile and compact. These multi-purpose units are ideal for incubation and activation of cultures, enzyme reactions, immunoassays, melting/boiling points and a wide variety of other laboratory procedures. Each of the five models accept separate interchangeable modular blocks, accommodating various sample enclosures such as micro-tubes, centrifuge tubes, vials, microplates, and PCR strips or tubes. Each block has a thermometer well for measuring block temperature. Anodized aluminum modular blocks provide superior temperature stability and heat transfer. Heaters require Talboys modular heating blocks for operation. Modular blocks are sold separately (see pages 83-85).

### Operating Features:

High wattage, constant-temperature Dry Block Heaters are economical, versatile and compact.

**Microprocessor Control:** PID temperature controller maintains precise temperature control. Samples are heated to temperature quickly and accurately.

**Adjustment Knobs:** Dual temperature control knobs with dial markings from 1 to 10 for low temperature and high temperature adjustments. Low range knob adjusts from ambient to 100°C and high range knob adjusts from 75°C to 150°C.

**CAUTION!** To avoid possible electrical hazard, do not fill well or block opening with water or other fluids. Unit is designed as a dry bath/incubator.

### Operating Conditions:

Units can be run in conditions from 18 to 33°C (64 to 91°F), 20% to 80% relative humidity, non-condensing.

### Applications:

Coagulation and RH Studies.

### Ordering Information:

Units include a 92" (234cm) detachable, 3-wire cord and plug (230 volt units are supplied with Euro type plug). Modular blocks are sold separately (see pages 83-85). **5 year limited warranty on parts and labor.**



949512

Size	Temperature Range	Uniformity Within the Block @ 37°C	Temperature Stability @ 37°C	Uniformity Across Similar Blocks @ 37°C	Heat-Up Time to 100°C
1 block	Low Range: Ambient +5°C to 100°C High Range: 75°C to 150°C	120 volt units: ± 0.1°C 230volt units: ± 0.2°C	120 volt units: ± 1.0°C 230 volt units: ± 1.5°C	N/A	45 minutes
2 block			120 volt units: ± 1.5°C 230 volt units: ± 2.0°C	± 0.1°C	50 minutes
3 block			120 volt units: ± 2.0°C 230 volt units: ± 2.0°C	± 0.15°C	60 minutes
4 block			120 volt units: ± 2.0°C 230 volt units: ± 2.5°C	± 0.2°C	70 minutes
6 block			120 volt units: ± 2.0°C 230 volt units: ± 2.5°C	± 0.3°C	75 minutes

Standard Dry Block Heaters

Standard Dry Block Heaters				
Block Capacity	Dimensions (L x W x H)	Electrical (50/60 Hz)	Ship Weight	Part Number
1	12.4 x 8 x 3.5" (31.5 x 20.3 x 8.9cm)	120V   0.9 amps   110 watts	5.8lbs (2.6kg)	949510
1	12.4 x 8 x 3.5" (31.5 x 20.3 x 8.9cm)	230V   0.5 amps   110 watts	5.8lbs (2.6kg)	949511
2	15.4 x 8 x 3.5" (39.1 x 20.3 x 8.9cm)	120V   1.7 amps   210 watts	6.4lbs (2.9kg)	949512
2	15.4 x 8 x 3.5" (39.1 x 20.3 x 8.9cm)	230V   0.9 amps   210 watts	6.4lbs (2.9kg)	949513
3	18.4 x 8 x 3.5" (46.7 x 20.3 x 8.9cm)	120V   1.7 amps   210 watts	8.0lbs (3.6kg)	949514
3	18.4 x 8 x 3.5" (46.7 x 20.3 x 8.9cm)	230V   0.9 amps   210 watts	8.0lbs (3.6kg)	949515
4	16.9 x 8 x 3.5" (42.9 x 20.3 x 8.9cm)	120V   2.6 amps   310 watts	8.5lbs (3.9kg)	949516
4	16.9 x 8 x 3.5" (42.9 x 20.3 x 8.9cm)	230V   1.3 amps   310 watts	8.5lbs (3.9kg)	949517
6	20.9 x 8 x 3.5" (53.1 x 20.3 x 8.9cm)	120V   3.4 amps   410 watts	10.0lbs (4.5kg)	949518
6	20.9 x 8 x 3.5" (53.1 x 20.3 x 8.9cm)	230V   1.7 amps   410 watts	10.0lbs (4.5kg)	949519

## Advanced Dry Block Heater with Heated Lid

- Exceptional uniformity, stability, and regulation of temperature
- Heated lid reduces condensation on sample lids
- Optional external temperature probe

Talboys Advanced Dry Block Heaters with Heated Lid are designed for applications that require repeatable results and superior temperature stability. These multi-purpose units are ideal for isothermal incubation, enzyme reactions, immunoassays, nucleic acid denaturation and a wide variety of other laboratory procedures. Integral support rod holder with locking knob accepts optional External Temperature Probe Kit. Optional External Temperature Probe Kit monitors actual block or sample temperature. Block heater accepts one microplate block or two separate interchangeable modular blocks, accommodating various tube sizes from 0.2mL micro-tubes to test tubes or vials up to 85mm in height. Each block has a thermometer well for measuring block temperature. Efficient heating due to close tube-and-block contact with a low density design for exceptional temperature uniformity. The heated lid helps to regulate the temperature and reduce the amount of condensation on sample lids. Heaters require Talboys modular heating blocks for operation. Modular blocks are sold separately (see pages 83-85).

### Operating Features:

**Microprocessor Control:** PID temperature control, with optional external RTD probe, offers a temperature stability as low as  $\pm 0.1^\circ\text{C}$  with a temperature uniformity as low as  $\pm 0.1^\circ\text{C}$ . Samples are heated to temperature quickly and accurately. Temperature is adjusted in  $\pm 0.1^\circ\text{C}$  increments.

**LED Display:** Touch pad controls with easy-to-read, independent LED displays for temperature, and time. Provides repeatable and accurate results every time and is easily visible across lab benches. Shows set-point and actual temperature. Timer will display elapsed time or, when programmed to user defined limit, will shut off unit when time reaches zero. Display will show last used settings, even after power has been turned off.

**Temperature Calibration Mode:** Allows user to calibrate unit to an external temperature device.

### Safety Features:

**Caution Hot Indicator:** Hot warning symbol light is illuminated when the temperature is above  $40^\circ\text{C}$ .

**Overshoot Protection:** If the unit exceeds the set temperature by  $10^\circ\text{C}$  the unit will automatically stop heating.

**Audible Alarm:** In timed mode, alarm will sound when time reaches zero and when unit reaches set-point temperature.

**CAUTION!** To avoid possible electrical hazard, do not fill well or block opening with water or other fluids. Unit is designed as a dry bath/incubator.



949502HL

### Operating Conditions:

Units can be run in environments from 18 to  $33^\circ\text{C}$  ( $64$  to  $91^\circ\text{F}$ ), 20% to 80% relative humidity, non-condensing.

### Applications:

Isothermal incubation, enzyme reactions, immunoassays and nucleic acid denaturation and a wide variety of other laboratory procedures.

### Ordering Information:

Units include a 92" (234cm) detachable, 3-wire cord and plug (230 volt units are supplied with Euro type plug). For optional temperature probe kits see page 79. Modular blocks sold separately (see pages 83-85). **5 year limited warranty on parts and labor.**

**Optional NIST Traceable Calibration Certificate** provided by Troemner's ISO/IEC 17025 accredited laboratory. Multiple data points within the temperature range and time function are reported on the certificate with the associated uncertainties.

Size	Temperature Range	Temperature Stability @ $37^\circ\text{C}$	Uniformity Within the Block @ $37^\circ\text{C}$	Uniformity Across Similar Blocks @ $37^\circ\text{C}$	Heat-Up Time to $100^\circ\text{C}$
2 block	Ambient $+5^\circ\text{C}$ to $100^\circ\text{C}$	120 volt units: $\pm 0.1^\circ\text{C}$ 230 volt units: $\pm 0.2^\circ\text{C}$	120 volt units: $\pm 0.1^\circ\text{C}$ 230 volt units: $\pm 0.2^\circ\text{C}$	$\pm 0.1^\circ\text{C}$ $\pm 0.2^\circ\text{C}$	50 minutes

Advanced Dry Block Heaters					
Block Capacity	Dimensions (L x W x H)	Electrical (50/60 Hz)		Ship Weight	Part Number
2	15.4 x 8 x 7" (39.1 x 20.3 x 17.8cm)	120V	3.0 amps   400 watts	7lbs (3.2kg)	949502HL
2	15.4 x 8 x 7" (39.1 x 20.3 x 17.8cm)	230V	1.65 amps   400 watts	7lbs (3.2kg)	949503HL

Advanced Dry Block Heaters with NIST Traceable Certificate					
Block Capacity	Dimensions (L x W x H)	Electrical (50/60 Hz)		Ship Weight	Part Number
2	15.4 x 8 x 7" (39.1 x 20.3 x 17.8cm)	120V	3.0 amps   400 watts	7lbs (3.2kg)	949702HL
2	15.4 x 8 x 7" (39.1 x 20.3 x 17.8cm)	230V	1.65 amps   400 watts	7lbs (3.2kg)	949703HL

Modular Blocks & Accessories

Modular blocks are constructed from a solid anodized aluminum block. The close contact of tubes-to-block walls allow for maximum heat retention. Each block has a thermometer well for measuring block temperature. **CAUTION!** To avoid possible electrical hazard, do not fill well or block with water or other fluids. Units are designed as a dry bath/incubator.

**Single block dimensions (L x W x H):** 3.75 x 3 x 2" (9.5 x 7.6 x 5.1cm)

**Double block dimensions (L x W x H):** 6 x 3.75 x 2.25" (15.2 x 9.5 x 5.7cm)

Microcentrifuge Tube Blocks

Single block.

Brand/Sample Type	No. of Wells	Well Dia.	Well Depth	Part Number
0.5mL Tube	30	7.9mm	27.6mm	949108
1.5mL Tube	20	11.1mm	39.1mm	949110
1.5mL Eppendorf™ Tube	20	11.5mm	36.9mm	949113
2mL Eppendorf™ Tube	20	11.5mm	38.1mm	949151
2mL Corning™ Tube	20	10.9mm	38.1mm	949152



Titer Plate Block

Double block. Fits 2/4/6 block Dry Block Heaters. Ideal for 96-well or 384-well titer plates. Recessed well for better stability, flat surface good for flat and round bottom plates.

Sample Type	Well Depth	Part Number
Titer Plate	13.5mm	949115



Conical-Bottom Centrifuge Tube Blocks

Single block.

Sample Type	No. of Wells	Well Dia.	Well Depth	Part Number
15mL Tube	12	17.1mm	44.5mm	949131
50mL Tube	5	29.0mm	47.6mm	949127



Standard Test Tube Blocks

Single block.

Sample Type	No. of Wells	Well Dia.	Well Depth	Part Number
6mm Tube	30	8.3mm	48.4mm	949109
10mm Tube	24	10.7mm	48.4mm	949102
12/13mm Tube	20	13.9mm	48.4mm	949103
12/13mm Tube	16	13.9mm	48.4mm	949116
15/16mm Tube	12	17.5mm	48.4mm	949104
17/18mm Tube	12	19.1mm	48.4mm	949155
20mm Tube	8	21.0mm	48.4mm	949105
25mm Tube	6	26.2mm	48.4mm	949106
35mm Tube	4	35.0mm	47.6mm	949126



### Combination Blocks

Single block. These blocks have been designed for variable sized samples.

Sample Type		No. of Wells	Well Dia.	Well Depth	Part Number
Test Tube Combination:	6mm	6	8.3mm	48.4mm	949107
	12/13mm	5	13.8mm	48.4mm	
	25mm	3	26.2mm	48.4mm	
Centrifuge Tube Combination:	1.5mL	4	11.1mm	39.1mm	949153
	15mL	3	17.1mm	44.5mm	
	50mL	2	29.0mm	47.6mm	
Micro-Tube Combination:	0.5mL	6	7.9mm	27.6mm	949154
	1.5mL	10	11.1mm	39.1mm	
	2mL	5	11.5mm	38.1mm	



### Vial Blocks

Single block. Designed for sample/serum and scintillation vials.

Sample Type	No. of Wells	Well Dia.	Well Depth	Part Number
12mm Vial	20	12.7mm	30mm	949142
15mm Vial	20	15.8mm	35mm	949143
16mm Vial	15	16.4mm	45mm	949150
17mm Vial	12	17.8mm	45mm	949144
19mm Vial	12	19.7mm	45mm	949145
21mm Vial	9	21.7mm	45mm	949146
23mm Vial	8	23.8mm	45mm	949147
25mm Vial	8	25.8mm	45mm	949148
28mm Vial	6	28.8mm	45mm	949149



### PCR - Plate, Tube, Strip Blocks

Single and double block. Tapered tube wells for 0.2mL tubes. Spaced for easy access and removal.

Sample Type	Block Size	No. of Wells	Well Dia.	Well Depth	Part Number
96-well PCR Plate	Double	96	6.4mm	15.5mm	949130
10 x 8 Tube Strips	Single	80	6.4mm	15.5mm	949128
Individual Tubes	Single	64	6.4mm	20.2mm	949129



### Cuvette Block

Single block. Two parallel slots fit 6 cuvettes in each slot, side-by-side.

Sample Type	No. of Wells	Well Depth	Part Number
(12) 12.5mm Cuvettes	2	25.4mm	949112





Modular Blocks & Accessories

**Solid Blocks**

Single and double block. For use as a low-temperature hotplate, slide drying, or for custom drilling to make a custom block.

Block Size	Dimensions (L x W x H)	Part Number
Single	3.75 x 3 x 2" (9.5 x 7.6 x 5.1cm)	949111
Double	6 x 3.75 x 2.25" (15.2 x 9.5 x 5.7cm)	949117



**Stainless Steel Sand Baths**

Ideal for irregular vessels. Stainless steel construction for superior corrosion resistance. Designed to hold sand, stainless steel shot or non-volatile fluids.

For Unit	Dimensions (L x W x H)	Part Number
1 Block Dry Block Heater	3.8 x 3.0 x 2.5" (9.5 x 7.6 x 6.4cm)	949132
2 Block Dry Block Heater	3.8 x 5.9 x 2.5" (9.5 x 14.9 x 6.4cm)	949133
3 Block Dry Block Heater	3.8 x 8.8 x 2.5" (9.5 x 22.4 x 6.4cm)	949134
4 Block Dry Block Heater	5.8 x 7.5 x 2.5" (14.7 x 19.1 x 6.4cm)	949135
6 Block Dry Block Heater	5.8 x 11.3 x 2.5" (14.7 x 28.7 x 6.4cm)	949136

Accessories	Part Number
Sand, 1lb (0.45kg)	949137
Stainless Steel Shot, 1lb (0.45kg)	949138



**Low Temperature Covers**

Plexiglass cover reduces air flow for additional temperature stability in low-temperature applications. Two sides are open 0.25" (6.4mm).

Block Size	Dimensions (L x W x H)	Part Number
2 Block Cover	6.5 x 6.5 x 1.6" (16.5 x 16.5 x 4.1cm)	949139
4 Block Cover	8.5 x 8.5 x 1.6" (21.6 x 21.6 x 4.1cm)	949140
6 Block Cover	12.5 x 8.5 x 1.6" (31.8 x 21.6 x 4.1cm)	949141





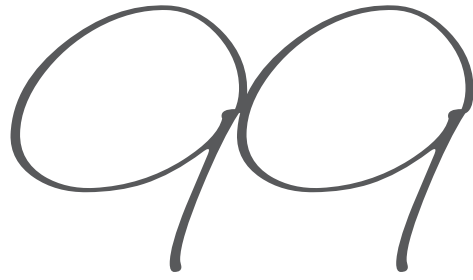



## Advanced Touch Heavy-Duty Vortex Mixers



- Intuitive 4.3" color touch screen
- Programmable for 5 separate, 5-step programs; with looping
- Custom pulsing for a more vigorous mix for problem samples
- On-board help screens
- Over 15 accessory options
- Programmable speed ramping feature (4 options)
- Includes NIST traceable certificate for speed and time

The Talboys Advanced Touch Heavy-Duty Vortex Mixer is ideal for applications that demand repeatable results. The heavy-duty design and efficient brushless DC motor allow this mixer to operate in continuous duty and handle all accessories over the entire speed range. Designed for continuous or programmed operation, unit can also be used to mix single tubes or vessels in Touch Mode.

### Operating Features:

**LCD Touch Screen:** Enables faster setting of speed and time which can be viewed at once. Display features on-screen help topics. Touch screen is compatible with rubber gloves used in labs.

**USB:** USB port can transfer data to a flash drive for data logging, program storage and software updates.

**Program Control:** Program control capabilities allow user programmable operation for automated use and memory. Storage for five separate, 10-step programs, or unlimited number of programs with the use of the USB. Programs can be repeated or looped up to 10 times.

**Pulse Mode Feature:** The unit is equipped with a pulse mode feature ideal for quick mixing.

**Microprocessor Control:** The variable speed microprocessor control provides consistent uniform mixing action. Microprocessor will display last set-point and will restart if power is interrupted (continuous mode).

### Safety Features:

**Speed Ramping Feature:** Programmable, allows control of ramping to desired set-point to avoid splashing.

**Audible Alarm:** In timed mode, alarm will sound when time reaches zero.

**Spill Resistant Design:** Channels fluids away from internal components.

### Operating Conditions:

Unit can be run in conditions from 4 to 40°C (39 to 104°F), maximum 85% relative humidity, non-condensing.

### Applications:

ELISA assays and general mixing of multiple samples or flasks.

### Ordering Information:

Mixer includes a cup head, universal holder with cover, foam microtube insert for (38) 1.5 to 2.0 mL microtubes, and a 92" (234cm) detachable, 3-wire cord plug (230V units are supplied with Euro type plug). Additional accessories can be found on page 92. **5 year limited warranty on parts and labor.**

**NIST Traceable Calibration Certificate** provided by Troemner's ISO/IEC 17025 accredited laboratory. Multiple data points within the speed range and time function are reported on the certificate with the associated uncertainties.



9456TAHDTUSAC

### Specifications

Speed Range	Continuous Mode:	300 to 2500rpm
	Touch Mode:	300 to 3500rpm
Speed Increments		10rpm
Timer		1 minute to 99 hours, 59 minutes
Orbit		4.9mm (0.19")
Capacity		2.5lbs (1.1kg)
Dimensions (L x W x H)		9.5 x 6.6 x 6.3" (24.1 x 16.8 x 16.5cm)
Ship Weight		15.5lbs (7kg)

### THIS PRODUCT INCLUDES:

Description	Part Number
Cup Head	9456TACUPHD



Description	Part Number
Universal Holder	9456TAUNIHLD
Universal Holder Cover	9456TAUNICVR



Description	Part Number
Foam Insert (1.5 to 2.0 microtubes)	9456TAMTB15
Universal Holder Cover	9456TAUNIHLD



Description	Electrical (50/60 Hz)	Part Number
Advanced Touch Heavy-Duty Vortex Mixer with NIST Traceable Certificate	120V   0.25 amps   30 watts	9456TAHDTUSAC
Advanced Touch Heavy-Duty Vortex Mixer-Euro Plug with NIST Traceable Certificate	230V   0.13 amps   30 watts	9456TAHDTSEUAC

## Standard Heavy-Duty Vortex Mixers

- Designed for continuous duty
- Includes foam insert for 1.5mL to 2.0mL microtubes
- Heavy-duty design

The Talboys Standard Heavy-Duty Vortex Mixer is a variable speed analog mixer that is designed for continuous duty. The heavy-duty design and efficient motor allow this mixer to operate in continuous duty and handle all accessories over the entire speed range. Choose from two modes of operation: "Touch" mode for mixing tubes when cup head or Universal Holder with cover is depressed, or "On" mode when using any of the accessory attachments for continuous operation.

### Operating Conditions:

Unit can be run in conditions from 4 to 40°C (39 to 104°F), 20% to 85% relative humidity, non-condensing.

### Ordering Information:

Mixer includes a cup head, universal holder with cover, foam microtube insert for (38) 1.5 to 2.0 mL microtubes, and a 92" (234cm) detachable, 3-wire cord and specified plug. Additional accessories can be found on page 92. **5 year limited warranty on parts and labor.**

### THIS PRODUCT INCLUDES:

Description	Part Number
Cup Head	9456TACUPHD



Description	Part Number
Universal Holder	9456TAUNIHLD
Universal Holder Cover	9456TAUNICVR



Description	Part Number
Foam Insert (1.5 to 2.0 microtubes)	9456TAMTB15
Universal Holder Cover	9456TAUNIHLD



9456TAHDUSS with  
9456TAT2629

### Specifications

Speed Range	On Mode: Touch Mode:	300 to 2500rpm 300 to 3500rpm
Orbit		4.9mm (0.19")
Controls		Analog
Capacity		2.5lbs (1.1kg)
Duty Rating		Continuous duty
Dimensions (L x W x H)		9.5 x 6.6 x 6.3" (24.1 x 16.8 x 16cm)
Ship Weight		15lbs (6.8kg)

Description	Electrical (50/60 Hz)	Part Number
Standard Heavy-Duty Vortex Mixer	120V   0.25 amps   30 watts	9456TAHDUSS
Standard Heavy-Duty Vortex Mixer-Euro Plug	230V   0.13 amps   30 watts	9456TAHDEUS
Standard Heavy-Duty Vortex Mixer-UK Plug	230V   0.13 amps   30 watts	9456TAHDUKS
Standard Heavy-Duty Vortex Mixer-Swiss Plug	230V   0.13 amps   30 watts	9456TAHDCHS

Advanced Heavy-Duty Vortex Mixers



- Designed for continuous duty
- LED displays for speed and time
- Includes foam insert for 1.5mL to 2.0mL microtubes



9456TAHDUSA with 9456TAMPLT4

The Talboys Advanced Heavy-Duty Vortex Mixer is ideal for applications that demand repeatable results. Mixer features touchpad controls and LED displays for accurate speed (rpm) and time (minutes and seconds) results. The heavy-duty design and efficient motor allow this mixer to operate in continuous duty and handle all accessories over the entire speed range. Choose from two modes of operation: "Touch" mode for mixing tubes when cup head or Universal Holder with cover is depressed, or "On" mode when using any of the accessory attachments for continuous operation. Microprocessor control maintains set speed for strong, consistent mixing action. Timer will display elapsed time or, when programmed to user defined time limits, the unit will shut off when time reaches zero.

**Operating Features:**

**Microprocessor Control:** The variable speed microprocessor control provides consistent uniform mixing action.

**LED Display:** Touch pad controls with easy-to-read, independent LED displays for speed and time allow operator to view both settings at once. Provides repeatable and accurate results every time and is easily visible across lab benches. Timer will display elapsed time or, when programmed to user defined limit, will shut off unit when time reaches zero. Display will show last used settings, even after power has been turned off.

**Operating Conditions:**

Unit can be run in conditions from 4 to 40°C (39 to 104°F), 20% to 85% relative humidity, non-condensing.

**Ordering Information:**

Mixer includes a cup head, universal holder with cover, foam microtube insert for (38) 1.5 to 2.0 mL microtubes, and a 92" (234cm) detachable, 3-wire cord and specified plug. Additional accessories can be found on page 92. **5 year limited warranty on parts and labor.**

**Optional NIST Traceable Calibration Certificate** provided by Troemner's ISO/IEC 17025 accredited laboratory. Multiple data points within the speed range and time function are reported on the certificate with the associated uncertainties.

**THIS PRODUCT INCLUDES:**

Description	Part Number
Cup Head	9456TACUPHD



Description	Part Number
Universal Holder	9456TAUNIHL
Universal Holder Cover	9456TAUNICVR



Description	Part Number
Foam Insert (1.5 to 2.0 microtubes)	9456TAMTB15
Universal Holder Cover	9456TAUNIHL



Description	Electrical (50/60 Hz)	Part Number
Advanced Heavy-Duty Vortex Mixer	120V   0.25 amps   30 watts	9456TAHDUSA
Advanced Heavy-Duty Vortex Mixer-Euro Plug	230V   0.13 amps   30 watts	9456TAHDEUA
Advanced Heavy-Duty Vortex Mixer-UK Plug	230V   0.13 amps   30 watts	9456TAHDUKA
Advanced Heavy-Duty Vortex Mixer-Swiss Plug	230V   0.13 amps   30 watts	9456TAHDCHA
Advanced Heavy-Duty Vortex Mixer with NIST Traceable Certificate	120V   0.25 amps   30 watts	9456TAHDUSA-C
Advanced Heavy-Duty Vortex Mixer-Euro Plug with NIST Traceable Certificate	230V   0.13 amps   30 watts	9456TAHDEUA-C

### Standard Microplate Vortex Mixers

- Designed for continuous duty
- Designed for shaking microplates or tubes
- Optional double microplate holder available

The Talboys Standard Microplate Vortex Mixer is a variable speed analog mixer that is designed for continuous duty. The high speed and small orbit is optimal for effectively mixing microplates. Choose from two modes of operation: "Touch" mode which activates mixing when cup head is depressed, or "On" mode when using the microplate attachments for continuous operation.

#### Operating Conditions:

Unit can be run in conditions from 4 to 40°C (39 to 104°F), 20% to 85% relative humidity, non-condensing.

#### Ordering Information:

Mixer includes a cup head, single microplate holder, and a 92" (234cm) detachable, 3-wire cord and specified plug. Accessories that can be used on the Microplate Vortex Mixer are cup head, single microplate holder and double microplate holder. Additional accessories can be found on page 92. **5 year limited warranty on parts and labor.**

#### THIS PRODUCT INCLUDES:

Description	Part Number
Cup Head	9456TACUPHD



Description	Part Number
Microplate Holder (Single)	9456TAMPSGL



9456TAMPUSS

#### Specifications

Speed Range	On Mode:	300 to 2500rpm
	Touch Mode:	300 to 3500rpm
Orbit		3.5mm (0.13")
Controls		Analog
Capacity		2 microplates
Duty Rating		Continuous duty
Dimensions (L x W x H)		10.5 x 5.4 x 4.5" (26.7 x 13.7 x 11.4cm)
Ship Weight		12lbs (5.4kg)

Description	Electrical (50/60 Hz)	Part Number
Standard Microplate Vortex Mixer	120V   0.25 amps   30 watts	9456TAMPUSS
Standard Microplate Vortex Mixer-Euro Plug	230V   0.13 amps   30 watts	9456TAMPEUS
Standard Microplate Vortex Mixer-UK Plug	230V   0.13 amps   30 watts	9456TAMPUKS
Standard Microplate Vortex Mixer-Swiss Plug	230V   0.13 amps   30 watts	9456TAMPCHS



Advanced Microplate Vortex Mixers



- Designed for continuous duty
- Designed for shaking microplates or tubes
- LED displays for speed and time

The Talboys Advanced Microplate Vortex Mixer is ideal for applications that demand repeatable results. Mixer features touchpad controls and LED displays for accurate speed (rpm) and time (minutes and seconds) results. Microprocessor control maintains set speed for strong, consistent mixing action. Timer will display elapsed time or, when programmed to a user defined time limit, the unit will shut off when time reaches zero. Choose from two modes of operation: "Touch" mode which activates mixing when cup head is depressed, or "On" mode when using the microplate attachments for continuous operation.

**Operating Features:**

**Microprocessor Control:** The variable speed microprocessor control provides consistent uniform mixing action.

**LED Display:** Touch pad controls with easy-to-read, independent LED displays for speed and time allow operator to view both settings at once. Provides repeatable and accurate results every time and is easily visible across lab benches. Timer will display elapsed time or, when programmed to user defined limit, will shut off unit when time reaches zero. Display will show last used settings, even after power has been turned off.

**Operating Conditions:**

Unit can be run in conditions from 4 to 40°C (39 to 104°F), 20% to 85% relative humidity, non-condensing.

**Ordering Information:**

Mixer includes a cup head, single microplate holder, and a 92" (234cm) detachable, 3-wire cord and specified plug. Accessories that can be used on the Microplate Vortex Mixer are cup head, single microplate holder and double microplate holder. Additional accessories can be found on page 92. **5 year limited warranty on parts and labor.**

**Optional NIST Traceable Calibration Certificate** provided by Troemner's ISO/IEC 17025 accredited laboratory. Multiple data points within the speed range and time function are reported on the certificate with the associated uncertainties.

**THIS PRODUCT INCLUDES:**

Description	Part Number
Cup Head	9456TACUPHD



Description	Part Number
Microplate Holder (Single)	9456TAMPSGL



9456TAMPUSA

**Specifications**

Speed Range	On Mode: 300 to 2500rpm Touch Mode: 300 to 3500rpm
Timer	1 second to 160 hours
Orbit	3.5mm (0.13")
Controls	Touch/Standby/On Rocker Switch, LED Displays For Speed/Time, Up/Down Buttons For Set-Point Control
Capacity	2 microplates
Duty Rating	Continuous duty
Dimensions (L x W x H)	10.5 x 5.4 x 4.5" (26.7 x 13.7 x 11.4cm)
Ship Weight	12lbs (5.4kg)

Description	Electrical (50/60 Hz)	Part Number
Advanced Microplate Vortex Mixer	120V   0.25 amps   30 watts	9456TAMPUSA
Advanced Microplate Vortex Mixer-Euro Plug	230V   0.13 amps   30 watts	9456TAMPEUA
Advanced Microplate Vortex Mixer-UK Plug	230V   0.13 amps   30 watts	9456TAMPUKA
Advanced Microplate Vortex Mixer-Swiss Plug	230V   0.13 amps   30 watts	9456TAMPCHA
Advanced Microplate Vortex Mixer with NIST Traceable Certificate	120V   0.25 amps   30 watts	9456TAMPUSA-C
Advanced Microplate Vortex Mixer-Euro Plug with NIST Traceable Certificate	230V   0.13 amps   30 watts	9456TAMPEUA-C

## Accessories

### Foam Insert for 0.5mL Microtubes

Foam insert holds (52) 0.5mL microtubes. Requires Universal Holder.

Description	Part Number
0.5mL microtubes	9456TAMTB05
Universal Holder	9456TAUNIHLDR



### Foam Insert for 1.5 to 2.0mL Microtubes

Foam insert holds (38) 1.5 to 2.0mL microtubes. Requires Universal Holder.

Description	Part Number
1.5 to 2.0mL microtubes	9456TAMTB15
Universal Holder	9456TAUNIHLDR



### Foam Insert for 12-13mm Test Tubes

Foam insert holds (34) 12-13mm diameter test tubes. Requires Universal Holder.

Description	Part Number
12-13mm test tubes	9456TAT1213
Universal Holder	9456TAUNIHLDR



### Foam Insert for 15-18mm Test Tubes

Foam insert holds (20) 15-18mm diameter test tubes. Ideal for 15mL centrifuge tubes. Requires Universal Holder.

Description	Part Number
15-18mm test tubes	9456TAT1518
Universal Holder	9456TAUNIHLDR



### Foam Insert for 19-21mm Test Tubes

Foam insert holds (18) 19-21mm diameter test tubes. Requires Universal Holder.

Description	Part Number
19-21mm test tubes	9456TAT1921
Universal Holder	9456TAUNIHLDR



### Foam Insert for 22-25mm Test Tubes

Foam insert holds (13) 22-25mm diameter test tubes. Requires Universal Holder.

Description	Part Number
22-25mm test tubes	9456TAT2225
Universal Holder	9456TAUNIHLDR



### Foam Insert for 26-29mm Test Tubes

Foam insert holds (4) 26-29mm diameter test tubes. Ideal for 50mL centrifuge tubes. Requires Universal Holder.

Description	Part Number
26-29mm test tubes	9456TAT2629
Universal Holder	9456TAUNIHLDR



### Single Tube Holder

Single tube, hands free mixing designed to fit on the Heavy-Duty Vortex Mixer. Easily attached to the top of mixer and is magnetically secured. Accepts tubes from 2.5 to 4.5" (6.4-11.4cm). Minimum tube diameter is 0.75" (19mm).

Description	Part Number
Single Holder	9456TASTHLDR



### Cup Head

Designed for mixing 1 tube at a time.

Description	Part Number
Cup Head	9456TACUPHD



### Small Vessel Holder

Rubber holder secures 125 and 250mL Erlenmeyer flasks. Vessel holder also includes a grip mat. Requires Universal Holder.

Description	Part Number
Small Vessel Holder	9456TASMVSL
Universal Holder	9456TAUNIHLDR



### Large Vessel Holder

Rubber holder secures 500 and 1000mL Erlenmeyer flasks. Vessel holder also includes a grip mat. Requires Universal Holder.

Description	Part Number
Large Vessel Holder	9456TALGVSL
Universal Holder	9456TAUNIHLDR



### Microplate Holder (Single)

Designed to hold one standard microplate.

Description	Part Number
Single Holder	9456TAMPSTK



### Microplate Holder (Double)

Designed to hold two standard microplates.

Description	Part Number
Double Holder	9456TAMPDBL



### Microplate Holder (Quad)

Designed to hold four standard microplates.

Description	Part Number
Quad Holder	9456TAMPPLT4



### Stackable Microplate Holder Four

Designed to maximize the capacity of the Heavy-Duty Vortex Mixer to eight microplates by stacking the tray on top of the four plate holder.

Description	Part Number
Stackable Holder	9456TAMP4STK



### Flat Foam Insert

Ideal for custom applications. Can be cut or drilled to fit your specifications. Requires Universal Holder.

Description	Part Number
Flat Foam Insert	9456TABLANK
Universal Holder	9456TAUNIHLDR



### Universal Holder & Cover

Replacement for items supplied with Heavy-Duty Vortex Mixer. Cover allows for mixing irregularly shaped objects.

Description	Part Number
Universal Holder	9456TAUNIHLDR
Universal Holder Cover	9456TAUNICVR



Basic Vortex Mixers



- Fixed high speed mixing
- Touch mode operation
- Includes cup head and 3" head with cover

Starts mixing when the cup head is pressed down. Speed is fixed at full rpm to provide vigorous vortexing of samples.

**Operating Conditions:**

Unit can be run in conditions from 4 to 40°C (39 to 104°F), 20% to 85% relative humidity, non-condensing.

**Ordering Information:**

Includes both cup head and 3" head with cover. Additional accessories can be found on pages 97-98. **5 year limited warranty on parts and labor.**

**THIS PRODUCT INCLUDES:**

Description	Part Number
Cup Head	945643



Description	Part Number
3" (7.6cm) Head	945641
3" (7.6cm) Rubber Head Cover	945642



945610

Specifications		
Speed Range*	120V	3200rpm
	230V	2500rpm
Orbit	4.9mm (0.19")	
Controls	None	
Duty Rating	Intermittent duty	
Dimensions (L x W x H)	8 x 5 x 5.25" (20.3 x 12.7 x 13.3cm)	
Ship Weight	14.4lbs (6.5kg)	

\* Maximum speed will vary depending on accessory used.

Description	Electrical (50/60 Hz)	Part Number
Basic Vortex Mixer	120V   1.2 amps   150 watts	945610
Basic Vortex Mixer-US Plug	230V   0.6 amps   150 watts	945611
Basic Vortex Mixer-UK Plug	230V   0.6 amps   150 watts	945612
Basic Vortex Mixer-Euro Plug	230V   0.6 amps   150 watts	945613
Basic Vortex Mixer-Swiss Plug	230V   0.6 amps   150 watts	945614

### Standard Vortex Mixers

- Variable, analog speed control
- Continuous or touch mode operation
- Includes cup head and 3" head with cover

Control allows low rpm start-up for gentle shaking or high speed mixing for vigorous vortexing of samples. Two modes of operation: "Continuous" mode when using accessory attachments or "Touch" mode which activates mixing when depressing the cup head.

#### Operating Conditions:

Unit can be run in conditions from 4 to 40°C (39 to 104°F), 20% to 85% relative humidity, non-condensing.

#### Ordering Information:

Includes both cup head and 3" head with cover. Additional accessories can be found on pages 97-98. **5 year limited warranty on parts and labor.**

#### THIS PRODUCT INCLUDES:

Description	Part Number
Cup Head	945643



Description	Part Number
3" (7.6cm) Head	945641
3" (7.6cm) Rubber Head Cover	945642



945600

Specifications		
Speed Range*	120V	300 to 3200rpm
	230V	300 to 2500rpm
Orbit	4.9mm (0.19")	
Controls	Auto/Off/On Rocker Switch, Speed Knob: Variable 1 to 10 Dial Marks	
Duty Rating	Intermittent duty	
Dimensions (L x W x H)	8 x 5 x 5.25" (20.3 x 12.7 x 13.3cm)	
Ship Weight	14.4lbs (6.5kg)	

\* Maximum speed will vary depending on accessory used.

Description	Electrical (50/60 Hz)	Part Number
Standard Vortex Mixer	120V   1.2 amps   150 watts	945600
Standard Vortex Mixer-US Plug	230V   0.6 amps   150 watts	945601
Standard Vortex Mixer-UK Plug	230V   0.6 amps   150 watts	945604
Standard Vortex Mixer-Euro Plug	230V   0.6 amps   150 watts	945605
Standard Vortex Mixer-Swiss Plug	230V   0.6 amps   150 watts	945606

Advanced Vortex Mixers



- LED displays for speed and time
- Continuous or touch mode operation
- Microprocessor controls

Ideal for applications that demand repeatable results. Microprocessor control maintains set speed for strong, consistent mixing action. Timer will display elapsed time or, when programmed to user defined time limit, the unit will shut off when time reaches zero. Two modes of operation: "Continuous" mode when using accessory attachments or "Touch" mode which activates mixing when depressing the cup head.

**Operating Features:**

**Microprocessor Control:** The variable speed microprocessor control provides consistent uniform mixing action.

**LED Display:** Touch pad controls with easy-to-read, independent LED displays for speed and time allow operator to view both settings at once. Provides repeatable and accurate results every time and is easily visible across lab benches. Timer will display elapsed time or, when programmed to user defined limit, will shut off unit when time reaches zero. Display will show last used settings, even after power has been turned off.

**Operating Conditions:**

Unit can be run in conditions from 4 to 40°C (39 to 104°F), 20% to 85% relative humidity, non-condensing.

**Ordering Information:**

Includes both cup head and 3" head with cover. Additional accessories can be found on pages 97-98. **5 year limited warranty on parts and labor.**

**Optional NIST Traceable Calibration Certificate** provided by Troemner's ISO/IEC 17025 accredited laboratory. Multiple data points within the speed range and time function are reported on the certificate with the associated uncertainties.

**THIS PRODUCT INCLUDES:**

Description	Part Number
Cup Head	945643
Description	Part Number
3" (7.6cm) Head	945641
3" (7.6cm) Rubber Head Cover	945642



945603

**Specifications**

Speed Range*	120V 230V	500 to 3000rpm 500 to 2500rpm
Timer		1 second to 160 hours
Orbit		4.9mm (0.19")
Controls		Auto/Standby/On Rocker Switch, LED Displays For Speed/Time, Up/Down Buttons For Set-Point Control
Duty Rating		Intermittent duty
Dimensions (L x W x H)		8 x 5 x 5.25" (20.3 x 12.7 x 13.3cm)
Ship Weight		14.4lbs (6.5kg)

\* Maximum speed will vary depending on accessory used.

Description	Electrical (50/60 Hz)	Part Number
Advanced Vortex Mixer	120V   1.2 amps   150 watts	945603
Advanced Vortex Mixer-US Plug	230V   0.6 amps   150 watts	945616
Advanced Vortex Mixer-Euro Plug	230V   0.6 amps   150 watts	945617
Advanced Vortex Mixer-UK Plug	230V   0.6 amps   150 watts	945618
Advanced Vortex Mixer-Swiss Plug	230V   0.6 amps   150 watts	945619
Advanced Vortex Mixer with NIST Traceable Certificate	120V   1.2 amps   150 watts	945603-C
Advanced Vortex Mixer-Euro Plug with NIST Traceable Certificate	230V   0.6 amps   150 watts	945617-C

## Pulsing Vortex Mixers

- LED displays for time and speed
- Continuous or touch mode operation
- Glass bead cell disruption/homogenization

Powerful pulsing vortex action produces excellent cell disruption for glass bead procedures. Microprocessor controlled. Capable of complete cell disruption of samples in only minutes. Unique pulsing action reduces heat generation while providing more effective mixing and disruption. Displayed time counts up during continuous operation and counts down during timed runs.

### Operating Features:

**Microprocessor Control:** The variable speed microprocessor control provides consistent uniform mixing action.

**LED Display:** Touch pad controls with easy-to-read, independent LED displays for speed and time allow operator to view both settings at once. Provides repeatable and accurate results every time and is easily visible across lab benches. Timer will display elapsed time or, when programmed to user defined limit, will shut off unit when time reaches zero. Display will show last used settings, even after power has been turned off.

**Pulsing Mode:** Unique pulsing action reduces heat generation while providing more effective mixing and disruption.

### Operating Conditions:

Unit can be run in conditions from 4 to 40°C (39 to 104°F), 20% to 85% relative humidity, non-condensing.

### Ordering Information:

Includes cup head, 3" head with cover, and an easy-to-load 1.5mL to 2mL Micro-Tube Holder. Holder has a built-in cup head. Additional accessories can be found on pages 97-98. **5 year limited warranty on parts and labor.**

**Optional NIST Traceable Calibration Certificate** provided by Troemner's ISO/IEC 17025 accredited laboratory. Multiple data points within the speed range and time function are reported on the certificate with the associated uncertainties.

### THIS PRODUCT INCLUDES:

Description	Part Number
Cup Head	945643

Description	Part Number
3" (7.6cm) Head	945641
3" (7.6cm) Rubber Head Cover	945642

Description	Part Number
Stainless Steel Tube Holder	945646



945620

### Specifications

Speed Range*	120V 230V	500 to 3000rpm 500 to 2500rpm
Timer		1 second to 160 hours
Orbit		2.5mm (0.098")
Controls		Auto/Standby/On Rocker Switch, LED Displays For Speed/Time, Up/Down Buttons For Set-Point Control Pulse Button
Duty Rating		Intermittent duty
Dimensions (L x W x H)		8 x 5 x 5.25" (20.3 x 12.7 x 13.3cm)
Ship Weight		14.4lbs (6.5kg)

\* Maximum speed will vary depending on accessory used.

Description	Electrical (50/60 Hz)	Part Number
Pulsing Vortex Mixer	120V   1.2 amps   150 watts	945620
Pulsing Vortex Mixer-US Plug	230V   0.6 amps   150 watts	945621
Pulsing Vortex Mixer-Euro Plug	230V   0.6 amps   150 watts	945622
Pulsing Vortex Mixer-UK Plug	230V   0.6 amps   150 watts	945623
Pulsing Vortex Mixer-Swiss Plug	230V   0.6 amps   150 watts	945624
Pulsing Vortex Mixer with NIST Traceable Certificate	120V   1.2 amps   150 watts	945620-C
Pulsing Vortex Mixer-US Plug with NIST Traceable Certificate	230V   0.6 amps   150 watts	945621-C

Vortex Mixer Accessories

**Micro-Tube Holder**

Mixes (48) 0.25 to 2mL micro-tubes. Requires Insert Retainer.

Description	Part Number
Micro-Tube Holder (2 pack)	945638
Insert Retainer	945631



**Microplate Holder**

Ideal for mixing 96-well plates or deep well blocks. Requires Insert Retainer.

Description	Part Number
Microplate Holder (2 pack)	945639
Insert Retainer	945631



**9 to 13mm Tube Holder**

Ideal for mixing 5mL culture tubes and micro-vials. Requires Insert Retainer.

Description	Part Number
9 to 13mm Tube Holder (2 pack)	945634
Insert Retainer	945631



**Flat Foam Insert**

Ideal for custom applications. Can be cut or drilled to fit your specifications. Requires Insert Retainer.

Description	Part Number
Flat Foam Insert (2 pack)	945644
Insert Retainer	945631



**14 to 19mm Tube Holder**

Ideal for mixing up to (8) 15mL centrifuge tubes. Requires Insert Retainer.

Description	Part Number
14 to 19mm Tube Holder (2 pack)	945635
Insert Retainer	945631



**Ampule Tube Holder**

Mixes up to 4 storage vials and test tubes.

Description	Part Number
15 to 17mm Ampule Tube Holder	945647
10 to 17mm Ampule Tube Holder	945648



**20 to 25mm Tube Holder**

Ideal for mixing up to (8) 50mL centrifuge tubes. Requires Insert Retainer

Description	Part Number
20 to 25mm Tube Holder (2 pack)	945636
Insert Retainer	945631



**Stainless Steel Microtube Holder**

Mixes up to (12) 1.5 to 5mL tubes. Stainless steel construction.

Description	Part Number
Microtube Holder	945646



**Vessel Harness**

Mixes Erlenmeyer flasks and media bottles. Requires Insert Retainer.

Description	Part Number
Vessel Harness (2 pack)	945633
Insert Retainer	945631



**Micro-Tube and Microplate Holder Kit**

- Includes:
- 1 Micro-Tube Holder
  - 1 Microplate Holder
  - 1 Insert Retainer

Description	Part Number
Micro-Tube & Microplate Holder Kit	945637



**Cup Head**

Designed for mixing 1 tube at a time.

Description	Part Number
Cup Head	945643



**Tube Holder Kit**

- Includes:
- (1) 9 to 13mm Tube Holder
  - (1) 14 to 19mm Tube Holder
  - (1) 20 to 25mm Tube Holder
  - 1 Flat Foam Insert
  - 2 Vessel Harnesses
  - 1 Insert Retainer

Description	Part Number
Tube Holder Kit	945630



**3" Rubber Head Cover and 3" Head**

Designed for mixing irregular shaped objects.

Description	Part Number
3" (7.6cm) Rubber Head Cover	945642
3" (7.6cm) Head	945641
3" (7.6cm) Head with Rubber Cover	945651



 Talboys Vortex Mixer accessories are interchangeable with other manufacturers' models. Call 1-888-Talboys for assistance.

## Vortex Mixer Accessories

### Single Tube Holder

Single tube, hands free mixing. Easily attaches to the top of any Vortex Mixer with the use of a strong magnetic base. Accepts tubes from 2.5 to 4.5" (6.4 to 11.4cm) in length. Minimum tube diameter of 0.75" (19mm).

Description	Part Number
Single Tube Holder	945659



### Adapter for Vortex-Genie® Mixer\*

Adapter plate easily adheres to the Vortex-Genie® Mixer housing so Single Tube Holder (sold separately) can be attached.

Description	Part Number
Adapter plate	945660

\* The Vortex-Genie® Mixer is a registered trademark of Scientific Industries, Inc.



### Single Tube Holder Accessories

#### 0.5mL Micro-Tube Holder

Mixes (24) 0.5mL micro-tubes. For use with Single Tube Holder.

Description	Part Number
Micro-Tube Holder (0.5mL)	945655



#### 1.5mL to 2.0mL Micro-Tube Holder

Mixes (18) 1.5 to 2mL micro-tubes. For use with Single Tube Holder.

Description	Part Number
Microtube Holder (1.5mL to 2.0mL)	945656



### 200 Micron Zirconium Beads

#### Acid Washed Zirconium Grinding Beads

This high-density bead has enormous grinding energy; resulting in reduced grinding times. Beads have been acid washed to remove contaminants.

**Application:** Suitable for yeast and bacterial spores.

Description	Part Number
250 gram bottle	930117

#### Molecular Biology Grade Zirconium Grinding Beads

Treated to be DNase/RNase-free, these beads are useful for the preparation of samples for molecular biology applications.

**Application:** Preparation of cells for Real Time PCR.

Description	Part Number
250 gram bottle	930118

#### Low Protein Binding Zirconium Grinding Beads

Treated to be DNase/RNase-free, these beads are useful for the preparation of samples for molecular biology applications.

**Application:** Preparation of cells for Real Time PCR.

Description	Part Number
250 gram bottle	930119

### 400 Micron Silica/Glass Beads

#### Acid Washed Silica/Glass Beads

Useful for standard applications.

**Application:** Good for disrupting molds and yeast.

Description	Part Number
200 gram bottle	930111

#### Molecular Biology Grade Silica/Glass Beads

Treated to be DNase/RNase-free, these beads are useful for preparing samples for molecular analysis

**Application:** Molecular applications for disrupting molds and yeast.

Description	Part Number
200 gram bottle	930112

#### Low Protein Binding Silica/Glass Beads

These treated beads are low protein binding and useful for homogenizing samples for protein analysis.

**Application:** Disruption of molds/yeasts for high protein recovery.

Description	Part Number
200 gram bottle	930113

### 800 Micron Silica/Glass Beads

#### Acid Washed Silica/Glass Beads

Excellent impact energy due to their larger size.

**Application:** Good general grinding media for fungi and spores.

Description	Part Number
200 gram bottle	930114

#### Molecular Biology Grade Silica/Glass Beads

Beads are DNase/RNase-free treated and useful for the preparation of samples for molecular applications and analysis.

**Application:** Useful for disrupting fungi and spores.

Description	Part Number
200 gram bottle	930115

#### Low Protein Binding Silica/Glass Beads

Beads adsorb less protein than standard beads and are useful when high protein recovery is necessary.

**Application:** Best choice for preparation of filamentous fungi, spores or pollen that require high protein recovery.

Description	Part Number
200 gram bottle	930116



Standard Multi-Tube Vortexers



- Process up to 50 samples at a time
- Continuous or timed operation
- Includes foam rack for 12mm tubes

Conveniently angled front panel features rocker switch for run, time and standby modes.

**Operating Features:**

**Microprocessor Control:** The variable speed microprocessor control provides consistent uniform mixing action.

**Adjustment Knobs:** Basic speed and time knobs with 1 to 10 dial markings.

**Operating Conditions:**

Unit can be run in conditions from 4 to 40°C (39 to 104°F), 20% to 85% relative humidity, non-condensing.

**Applications:**

Suspensions, high throughput testing in clinical, environmental, and chemistry labs.

**Ordering Information:**

Unit includes a 92" (234cm) detachable, 3-wire cord and plug (230 volt units are supplied with Euro type plug). Unit is also supplied with a Tray Pad Set for support and one 12mm Test Tube Foam Rack (945072). Additional accessories can be found on pages 101. **5 year limited warranty on parts and labor.**

**Available in Stainless Steel**

One piece housing design optimizes clean-ups. Ideal for applications requiring accuracy and repeatability. The stainless steel one piece housing design is conducive to keeping your vortexer clean and free from contaminants.



945007 with 945072

Specifications	
Speed Range*	1200 to 2400rpm
Timer	0 to 60 seconds
Orbit	3.6mm (0.14")
Maximum Weight Capacity	10lbs (4.5kg)
Duty Rating	Continuous duty
Tray Dimensions (L x W)	7.25 x 12.25" (18.4 x 31.1cm)
Overall Dimensions (L x W x H)	9.5 x 15.1 x 16" (24.1 x 38.4 x 40.6 cm)
Ship Weight	42lbs (19.1kg)

\* Maximum speed will vary depending on load.

Description	Electrical (50/60 Hz)	Part Number
Standard Multi-Tube Vortexer	120V   0.8 amps   100 watts	945007
Standard Multi-Tube Vortexer	230V   0.4 amps   100 watts	945008
Standard Stainless Steel Multi-Tube Vortexer	120V   0.8 amps   100 watts	945007S
Standard Stainless Steel Multi-Tube Vortexer	230V   0.4 amps   100 watts	945008S

## Advanced Multi-Tube Vortexers

- Process up to 50 samples at a time
- LED displays for speed and time
- Pulsing mode

Ideal for applications requiring accuracy and repeatability.

### Operating Features:

**Microprocessor Control:** The variable speed microprocessor control provides consistent uniform mixing action.

**LED Display:** Touch pad controls with easy-to-read, independent LED displays for speed and time allow operator to view both settings at once. Provides repeatable and accurate results every time and is easily visible across lab benches. Timer will display elapsed time or, when programmed to user defined limit, will shut off unit when time reaches zero. Display will show last used settings, even after power has been turned off.

**Pulsing Mode:** Programmable pulsing mode allows user to adjust the pulse-on and pulse-off times between 1 and 59 seconds in 1 second intervals. This feature enhances the vortex action by creating a more vigorous mix.

### Operating Conditions:

Unit can be run in conditions from 4 to 40°C (39 to 104°F), 20% to 85% relative humidity, non-condensing.

### Applications:

Suspensions, high throughput testing in clinical, environmental, and chemistry labs.

### Ordering Information:

Unit includes a 92" (234cm) detachable, 3-wire cord and plug (230 volt units are supplied with Euro type plug). Unit is also supplied with a Tray Pad Set for support and one 12mm Test Tube Foam Rack (945072). Additional accessories can be found on pages 101. **5 year limited warranty on parts and labor.**

**Optional NIST Traceable Calibration Certificate** provided by Troemner's ISO/IEC 17025 accredited laboratory. Multiple data points within the speed range and time function are reported on the certificate with the associated uncertainties.

### Available in Stainless Steel

One piece housing design optimizes clean-ups. Ideal for applications requiring accuracy and repeatability. The stainless steel one piece housing design is conducive to keeping your vortexer clean and free from contaminants.



945065 with 945075

Specifications	
Speed Range*	500 to 2500rpm
Speed Accuracy	± 25rpm
Timer	1 second to 160 hours
Orbit	3.6mm (0.14")
Maximum Weight Capacity	10lbs (4.5kg)
Duty Rating	Continuous duty
Tray Dimensions (L x W)	7.25 x 12.25" (18.4 x 31.1cm)
Overall Dimensions (L x W x H)	9.5 x 15.1 x 16" (24.1 x 38.4 x 40.6 cm)
Ship Weight	42lbs (19.1kg)

\* Maximum speed will vary depending on load.

Description	Electrical (50/60 Hz)	Part Number
Advanced Multi-Tube Vortexer	120V   0.8 amps   100 watts	945065
Advanced Multi-Tube Vortexer	230V   0.4 amps   100 watts	945066
Advanced Multi-Tube Vortexer with NIST Traceable Certificate	120V   0.8 amps   100 watts	945065-C
Advanced Multi-Tube Vortexer with NIST Traceable Certificate	230V   0.4 amps   100 watts	945066-C
Advanced Stainless Steel Multi-Tube Vortexer	120V   0.8 amps   100 watts	945065S
Advanced Stainless Steel Multi-Tube Vortexer	230V   0.4 amps   100 watts	945066S
Advanced Stainless Steel Multi-Tube Vortexer with NIST Traceable Certificate	120V   0.8 amps   100 watts	945065S-C
Advanced Stainless Steel Multi-Tube Vortexer with NIST Traceable Certificate	230V   0.4 amps   100 watts	945066S-C

## Multi-Tube Vortexer Accessories

## Foam Test Tube Racks

Description	Tube Capacity	Color	Dimensions (L x W x H)	Part Number
10mm Test Tube Foam Rack	50	Gray	5.5 x 9.5 x 2" (14 x 24.1 x 5.1cm)	945071
12mm Test Tube Foam Rack	50	Blue	5.5 x 9.5 x 2" (14 x 24.1 x 5.1cm)	945072
13mm Test Tube Foam Rack	50	Yellow	5.5 x 9.5 x 2" (14 x 24.1 x 5.1cm)	945073
16mm Test Tube Foam Rack (for 15mL centrifuge tubes)	50	Green	5.5 x 9.5 x 2" (14 x 24.1 x 5.1cm)	945074
25mm Test Tube Foam Rack	28	White	5.5 x 9.5 x 2" (14 x 24.1 x 5.1cm)	945076
29mm Test Tube Foam Rack (for 50mL centrifuge tubes)	15	Red	5.5 x 9.5 x 2" (14 x 24.1 x 5.1cm)	945075
Replacement Tray Pad Set (upper & lower)	N/A	Gray	7 x 12 x 1" (17.8 x 30.5 x 2.5cm)	945010



## Post Extension Kit

Adds 6" (15.2cm) to the post of the Multi-Tube Vortex Mixer to accommodate tubes up to 10" (25.4cm) tall.

Description	Part Number
Post Extension Kit	945009





117

## Cryogenic Homogenizing System

- Handheld homogenizer with mortars and pestles
- Increases sample throughput
- System helps preserve sample integrity

The Talboys Cryogenic Homogenizing System combines the ease and speed of a handheld homogenizer and a liquid nitrogen cooled sample to homogenize your sample faster and more efficiently. The cordless, motorized 3.6 volt unit's speed is slower than a typical homogenizer to prevent sample splattering and generation of airborne particles. Compact and versatile design allows homogenizer to be held with a pistol grip.

The mortar and pestle are constructed of a durable porcelain/zirconium composite. The rugged pestle has a stainless steel shaft with a hex bit for quick connection to the motor. Mortar and pestle can be decontaminated between samples by autoclaving, dry heat, or by exposing to a commercial decontaminating solution. The Cryogenic Cooler is a valuable tool for chilling, processing, and transporting samples.

**Applications:**

Suspensions, high throughput testing in clinical, environmental, molecular biology, and chemistry labs.

**Ordering Information:**

Units include motor unit, tray with six mortar and pestles, Cryogenic Cooler with mesh covered sample reservoir and adsorbent material. **5 year limited warranty on parts and labor.**



Specifications	
Speed Range	200rpm
Sample Size	< 500 mg (100mg optimal)
Dimensions, Overall (W x L x H)	
Homogenizer	6 x 2 x 5.5" (15.2 x 5 x 14cm)
Cryo Cooler	11 x 9 x 11.5" (27.9 x 22.9 x 29.2cm)
Tray	5.5 x 5 x 1.2" (13.9 x 12.7 x 3.0cm)
Ship Weight	11lbs (5.0kg)

Description	Electrical (50/60 Hz)	Part Number
Cryogenic Homogenizing System	120V   1.0 amps   4 watts	930260

**Replacement Accessories**

Description	Part Number
Tray with six replacement mortar and pestles	930262
Pestles, set of 6 (replacement)	930263
Mortars, set of 6 (replacement)	930264
Cryogenic Cooler	930259

## High Throughput Homogenizer



- Ability to process small quantities
- Eliminates cross contamination
- Rapid sample processing

The Talboys High Throughput Homogenizer is specifically designed for high throughput sample processing in a microplate, vial set format or any 4 x 5 x 2.5" matrix to produce effective homogenization of tissue samples. Homogenizer produces a reciprocal motion that is optimized for grinding difficult samples. Easy-to-load tray securely locks microplate or sample holder in place. The high speed linear motion of the homogenizer allows for rapid sample processing; in most cases two minutes or less. Analog controls.

Homogenized samples can be subsequently handled manually or in an automated system. The High Throughput Homogenizer is suitable for the isolation of protein, DNA, RNA, viruses, and other biological components released during homogenization.

Animal tissue, seeds, tubers, leaf punches, soil and sediment samples, insects, and microbial cultures can all be effectively homogenized in a 96-well or vial set format. The unit is also useful for pulverizing dry samples for chemical analysis and solubility studies.

#### Operating Conditions:

Units can be run in conditions from 5 to 40°C (41 to 104°F), 20% to 85% relative humidity, non-condensing.

#### Ordering information:

Unit includes a 92" (234cm), 3-wire cord and plug (230 volt units are supplied with Euro type plug). **5 year limited warranty on parts and labor.**

#### Grinding Accessories

Grinding Vial Sets combine the benefits of the microplate format and the size of vials to provide a tool for higher throughput sample grinding. Vials are available in either polycarbonate or polyethylene materials. The polyethylene vial set is offered in a 24 vial, 4mL size. The polycarbonate vial set is offered in two sizes; 24 vial, 4mL size and 5 vial, 15mL size. The 4mL vial size is conveniently packaged as a set or in bulk.

Grinding balls are used with deep well plates and vial sets to bead beat plant tissues, seeds, and animal tissues. These grinding balls are made of 440C stainless steel which allows them to be retrieved with a magnet while making them resistant to tarnishing. Grinding balls are treated to remove residual oils and contaminants prior to packaging.

#### Recommended Applications:

- 3/8" Good for homogenizing seeds and larger samples of animal tissue in 4mL vials.
- 7/16" Suitable for larger grinding jobs, such as pooled seeds, in 15 mL vials.
- 5/32" Use with deep well plates for leaf punches or animal tissue of 50mg or less.

When homogenization is complete, grinding balls can be removed with optional 24-Pin Magnet.



930145

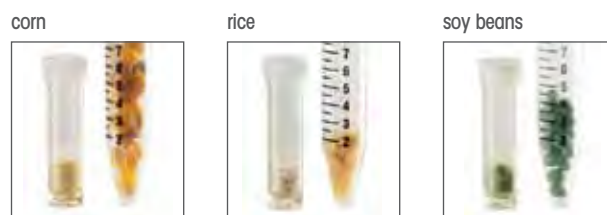

#### Specifications

Speed Range	0 to 1600rpm
Timer	1 to 10 minutes
Maximum Capacity	1 deep well plate, 4 stacked standard well plates, or 1 vial set; 300 gram maximum
Reciprocal Stroke	1.2" (3.1cm)
Dimensions, Overall (L x W x H)	17.5 x 15 x 14.2" (44.5 x 38.1 x 36.1cm)
Ship Weight	75lbs (34.1kg)

Description	Electrical (50/60 Hz)	Part Number
High Throughput Homogenizer	120V   6.3 amps   450 watts	930145
High Throughput Homogenizer	230V   3.1 amps   450 watts	930146

### Replacement Accessories

Description	Lid	Part Number
Bulk 4mL Polyethylene Vials, case of 240	Unlined	930148
Bulk 4mL Polyethylene Vials, case of 240	Lined	930155
Bulk 4mL Polycarbonate Vials, case of 240	Unlined	930147
Bulk 4mL Polycarbonate Vials, case of 240	Lined	930154
3/8" Stainless Steel Grinding Balls, pack of 1000	N/A	930156
5/16" Stainless Steel Grinding Balls, pack of 1000	N/A	930157
5/32" Stainless Steel Grinding Balls, pack of 5000	N/A	930151
6mm Zirconium Oxide Satellites, pack of 1000	N/A	930158
500 Micron Acid Washed Garnet, 250 gram	N/A	930159

### 24-Well 4mL Vial Sets, Polyethylene

Plastic case with foam rack holds 24, 4mL polyethylene vials. Each vial includes one, 3/8" (1cm) stainless steel grinding ball and threaded lid. Lid is available unlined or with lining for added secure closure. Sold as a case of 10 vial sets.

Description	Lid	Part Number
24-Well 4mL Vial Set, Polyethylene	Unlined	930136
24-Well 4mL Vial Set, Polyethylene	Lined	930153



930136

### 24-Well 4mL Vial Sets, Polycarbonate

Plastic case with foam rack holds 24, 4mL polycarbonate vials. Each vial includes one, 3/8" (1cm) stainless steel grinding ball and threaded lid. Lid is available unlined or with lining for added secure closure. Sold as a case of 10 vial sets.

Description	Lid	Part Number
24-Well 4mL Vial Set, Polycarbonate	Unlined	930135
24-Well 4mL Vial Set, Polycarbonate	Lined	930152



930135

### 5-Well 15mL Vial Set, Polycarbonate

Plastic case with foam rack holds 5, 15mL polycarbonate vials for larger samples. Each vial includes two, 7/16" (1.1cm) stainless steel grinding balls and threaded lid. Sold as a case of 10 vial sets.

Description	Lid	Part Number
5-Well 15mL Vial Set, Polycarbonate	Unlined	930137



930137



## High Throughput Homogenizer Accessories

**24-Pin Magnet and Magnet Stand/Ball Separator**

The 24-Pin Magnet can be used to remove grinding balls before samples are added to the vials and then, with the use of the Magnet Stand/Ball Separator, used to align and drop grinding balls into vials. Each 2" (5.1 cm) pin is capped with a strong neodymium rare earth magnet. The pins of this magnet can also be used to remove smaller grinding balls from 96-well plates.

Description	Part Number
24-Pin Magnet	930138
Magnet Stand/Ball Separator	930139

**Magnet Pipette Tips**

Magnet Pipette Tips are a simple, cost effective solution for removing stainless steel grinding balls from 96-well plates and grinding vials. The tips are made to fit most 0-200µl pipettes and work with steel and 440C stainless steel balls.

Description	Part Number
Magnet Pipette Tips, pack of 12	930149

**Ball Dropper/Bead Dispenser**

Ball Dropper/Bead Dispenser can be used to add 5/32" stainless steel balls to deep well plates, and to dispense small grinding beads into empty microplates. Includes ball dropper, reservoir tray, grinding bead swipe card, and plastic retaining sheet.

Description	Part Number
Ball Dropper/Bead Dispenser	930150













123

## Overhead Mixer Selection Guide

						
	101	102	105	103	103A	103X
<b>Horsepower</b>	1/75	1/75	1/80	1/12	1/12	1/12
<b>Type of Speed Control</b>	Electronic	Electronic	Fixed	Electronic	Electronic	Fixed
<b>Number of Output Shafts</b>	1	2	1	1	1	1
<b>Speed Range: Direct Drive</b>	500 to 7500rpm	500 to 7500rpm	1550rpm	1000 to 7500rpm	1000 to 7500rpm	7500rpm
10:1	N/A	50 to 750rpm	N/A	N/A	N/A	N/A
60:1	N/A	N/A	N/A	N/A	N/A	N/A
<b>Torque: Direct Drive</b>	0.15 in-lbs	0.15 in-lbs	0.5 in-lbs	0.7 in-lbs	0.7 in-lbs	0.7 in-lbs
10:1	N/A	1 in-lbs	N/A	N/A	N/A	N/A
60:1	N/A	N/A	N/A	N/A	N/A	N/A
<b>Electrical Specifications: Volts</b>	120 AC	120 AC	120 AC	120 AC	120 AC	120 AC
<b>Amps</b>	0.33	0.33	0.77	1.3	1.3	1.3
<b>Overall Usage Rating</b>	Light	Light	Light	High Speed	High Speed	High Speed
<b>Type of Chuck</b>	Collet, Model 192	Collet, Model 193	Collet, Model 192	Collet, Model 193	Collet, Model 193	Collet, Model 193
<b>Recommended Paddles</b>	150, 153A, 155, 165	151, 153B, 156, 161, 166	150, 153A, 155, 165	151, 153B	151, 153B	151, 153B

				
	134-2	138/238	4136	409/429
<b>Horsepower</b>	1/18	1/8	1/6	1/4
<b>Type of Speed Control</b>	Transi-Stir	Transi-Stir	Transi-Stir	Transi-Stir
<b>Number of Output Shafts</b>	3	2	2	1
<b>Speed Range: Direct Drive</b>	500 to 7500rpm	500 to 7500rpm	1000 to 5000rpm	50 to 500rpm
10:1	50 to 750rpm	50 to 750rpm	100 to 500rpm	N/A
60:1	10 to 125rpm	N/A	N/A	N/A
<b>Torque: Direct Drive</b>	0.5 in-lbs	1.2 in-lbs	1.5 in-lbs	25 in-lbs
10:1	4.7 in-lbs	12 in-lbs	15 in-lbs	N/A
60:1	15 in-lbs	N/A	N/A	N/A
<b>Electrical Specifications: Volts</b>	120 AC	120 AC	120 AC	120 AC
<b>Amps</b>	1.1	2.2	2.5	1.8
<b>Overall Usage Rating</b>	Heavy	Heavy	Heavy	Heavy
<b>Type of Chuck</b>	Adjustable, Model 191D	Collet, Model 193 & Adjustable, Model 191D	Collet, Model 193 & Adjustable, Model 191D	Adjustable, Model 191L
<b>Recommended Paddles</b>	All	All	All	All

### Three components that make up an Overhead Mixer system:

#### 1. Motor Unit



#### 2. Mixing Paddle



#### 3. Support Stand and Holder

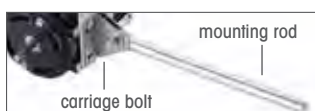

All mixers include an 8" (20.3cm) mounting rod with carriage bolt and wrench for mounting motor to support stands. An additional holder is required to attach the motor's mounting rod to a support stand except the model 409 (429) which includes Model 112 Heavy-Duty holder. Support stands and holders sold separately.

## Overhead Mixer Selection Guide



133

104

104A

104X

107

107SC

134-1

	133	104	104A	104X	107	107SC	134-1
<b>Horsepower</b>	1/12	1/18	1/18	1/18	1/30	1/30	1/18
<b>Type of Speed Control</b>	Transi-Stir	Electronic	Electronic	Fixed	Fixed	Electronic	Transi-Stir
<b>Number of Output Shafts</b>	1	2	2	2	1	1	2
<b>Speed Range: Direct Drive</b>	500 to 750rpm	1000 to 750rpm	1000 to 750rpm	750rpm	1600rpm	100 to 1600rpm	500 to 750rpm
10:1	N/A	100 to 750rpm	100 to 750rpm	750rpm	N/A	N/A	50 to 750rpm
60:1	N/A	N/A	N/A	N/A	N/A	N/A	N/A
<b>Torque: Direct Drive</b>	0.7 in-lbs	0.5 in-lbs	0.5 in-lbs	0.5 in-lbs	1.3 in-lbs	1.3 in-lbs	0.5 in-lbs
10:1	N/A	4.7 in-lbs	4.7 in-lbs	4.7 in-lbs	N/A	N/A	4.7 in-lbs
60:1	N/A	N/A	N/A	N/A	N/A	N/A	N/A
<b>Electrical Specifications: Volts</b>	120 AC	120 AC	120 AC	120 AC	120 AC	120 AC	120 AC
<b>Amps</b>	1.3	1.1	1.1	1.1	1.2	1.2	1.1
<b>Overall Usage Rating</b>	High Speed	Medium	Medium	Medium	Medium	Medium	Heavy
<b>Type of Chuck</b>	Collet, Model 193	Collet, Model 193	Collet, Model 193	Collet, Model 193	Collet, Model 193	Collet, Model 193	Adjustable, Model 191D
<b>Recommended Paddles</b>	151, 153B	All 5/16" Accessory Shafts*	All 5/16" Accessory Shafts*	All 5/16" Accessory Shafts*	151, 152, 153B, 156,166	151, 152, 153B, 156,166	All

\* Be sure the accessory shaft is 5/16" in diameter to fit Model 193 Collet Chuck.

## How to Select an Overhead Mixer

Review the following information to help you select the appropriate motor and accessories for your unique applications.

## Paddle Selection

- Viscosity of the sample
- Volume of the sample
- Size and shape of mixing vessel and vessel opening
- Speed needed to achieve proper mixing
- Paddle depth for effective mixing
- Paddle material: stainless steel, PTFE, or glass; may be dependent on the nature of the material being mixed
- Fluid flow: axial, radial

## Motor Selection

- Mixing speed
- Viscosity
- Duty Rating:
  - Light:
    - Ideal for low viscosity materials
    - Volumes under 10 gallons
  - High Speed:
    - Ideal for high speed dispersion and low viscosity
  - Medium:
    - Multi-purpose units designed for various mixing tasks
    - Gear reduction shaft provides more torque for higher viscosity mixing
    - Direct drive shaft is ideal for lower viscosity and high speed mixing
  - Heavy:
    - Designed for high viscosity applications or large batch mixing
    - Gear reduction provides the torque required for more difficult mixing applications.

## Speed Control

- Transi-stir:
  - Provides variable speed control throughout the entire speed range
  - Available top mounted or remotely attached
- Electronic:
  - Maintains set speed even under changing viscosity or load
  - Provides stepless, variable speed control
- Fixed:
  - Maintains fixed speed

## Support Stands and Holders

- Support stands are not included with motors
- Available in a variety of lengths
- Standard Holder supports the supplied rod for mounting most mixers
- Heavy-Duty Holder accommodates a wider range of sizes and is sturdier thus decreasing vibration

## Chucks

- Adjustable Jacobs style:
  - Not recommended for high speed mixing
- Precision Collet style:
  - Used when motor shaft and accessory shaft are the same diameter
  - Recommended when running at higher speeds
- Glass Rod:
  - Required chuck when using glass mixing rods
  - Designed to eliminate wobble and vibration common with glass mixing rods
  - Nylon inserts help maintain the integrity of glass mixing rods

## Light Duty Mixers

- General purpose mixers
- Economical, compact, and durable
- Up to 7500rpm

For low viscosity mixing. These light duty mixers offer low torque for general purpose mixing and have a continuous duty rating. Mixers include collet chuck and 8" (20.3cm) mounting rod with carriage bolt and wrench for mounting motor to support stands. An additional clamp (110B or 112) is required to attach the motor's mounting rod to a support stand. Support stands and holders sold separately (see page 145).



**Model 101**

- Top mounted Basic Speed Control
- Compact and economical for light duty mixing
- Offers a single shaft, direct drive motor
- Mixes up to five gallons of water

**Recommended accessory shafts:**  
150, 153A, 155, 165



**Model 102**

- Top mounted Basic Speed Control
- Provides increased torque with 10:1 gear reduction
- Offers the capability of two mixing shafts for multiple applications and added versatility
- Mixes up to two gallons of lightweight oils

**Recommended accessory shafts:**  
151, 153B, 156, 161, 166



**Model 105**

- Economic, light duty batch mixer without speed control offers a fixed speed of 1550rpm.
- An internal overload feature shuts down motor when it becomes too hot.
- Mixes five gallons of water.
- Adjusta-Speed Control (part number 115) upgrade available for this model (sold separately, see page 123)

**Recommended accessory shafts:**  
150, 153A, 155, 165

Specifications			
Model	101	102	105
<b>Horsepower</b>	1/75	1/75	1/80
<b>Speed Range</b>			
Direct Drive	500 to 7500rpm	500 to 7500rpm	1550rpm
10:1	N/A	50 to 750rpm	N/A
<b>Torque</b>			
Direct Drive	0.15 in-lbs	0.15 in-lbs	0.5 in-lbs
10:1	N/A	1 in-lbs	N/A
<b>Electrical</b>	120 volt, 0.33 amps	120 volt, 0.33 amps	120 volt, 0.77 amps
<b>Shaft Size</b>	1/4" (6.4mm)	5/16" (7.9mm)	1/4" (6.4mm)
<b>Chuck Type</b>	Collet	Collet	Collet
<b>Overall Dimensions (L x W x H)</b>	5 x 4.5 x 8" (12.7 x 11.4 x 20.3cm)	6.5 x 8.5 x 7" (16.5 x 21.6 x 17.8cm)	5 x 4.5 x 4" (12.7 x 11.4 x 10.2cm)
<b>Ship Weight</b>	4.6lbs (2.1kg)	5.1lbs (2.3kg)	4.6lbs (2.1kg)
<b>Part Number</b>	101	102	105

## High Speed Mixers

- Ideal for high speed dispersion up to 7500rpm
- Direct drive
- Continuous duty

Compact design for low torque, high speed mixing. Perfect units for low viscosity mixing. Each is configured with different speed control options. Mixers include collet chuck and 8" (20.3cm) mounting rod with carriage bolt and wrench for mounting motor to support stands. An additional clamp (110B or 112) is required to attach the motor's mounting rod to a support stand. Support stands and holders sold separately (see page 145).

**Model 103**

- Table mounted Basic Speed Control
- The speed control is remotely attached by a 42" (107cm) cord
- Speed control can be placed on a counter top or shelf close to the stirring apparatus

**Model 103A**

- Top mounted Basic Speed Control
- Compact, sturdy design

**Model 103X**

- An economical 7500rpm fixed speed mixer
- Powered with an on/off switch
- Adjusta-Speed Control (part number 115) upgrade available for this model (sold separately, see page 123)

**Model 133**

- Top mounted Standard Speed Control
- The perfect mixer for emulsions that require high speeds and more torque
- Maintains constant speed even when viscosity changes

**Recommended accessory shafts:**  
151, 153B

**Recommended accessory shafts:**  
151, 153B

**Recommended accessory shafts:**  
151, 153B

**Recommended accessory shafts:**  
151, 153B

Specifications				
Model	103	103A	103X	133
<b>Horsepower</b>	1/12	1/12	1/12	1/12
<b>Speed Range</b>				
Direct Drive	1000 to 7500rpm	1000 to 7500rpm	7500rpm	500 to 7500rpm
10:1	N/A	N/A	N/A	N/A
<b>Torque</b>				
Direct Drive	0.7 in-lbs	0.7 in-lbs	0.7 in-lbs	0.7 in-lbs
10:1	N/A	N/A	N/A	N/A
<b>Electrical</b>	120 volt, 1.3 amps	120 volt, 1.3 amps	120 volt, 1.3 amps	120 volt, 1.3 amps
<b>Shaft Size</b>	5/16" (7.9mm)	5/16" (7.9mm)	5/16" (7.9mm)	5/16" (7.9mm)
<b>Chuck Type</b>	Collet	Collet	Collet	Collet
<b>Overall Dimensions (L x W x H)</b>	5 x 4.4 x 8" (12.7 x 11.2 x 20.3cm)	5 x 4.4 x 8" (12.7 x 11.2 x 20.3cm)	5 x 4.4 x 8" (12.7 x 11.2 x 20.3cm)	5 x 4.4 x 8" (12.7 x 11.2 x 20.3cm)
<b>Ship Weight</b>	4.6lbs (2.1kg)	4.6lbs (2.1kg)	4.6lbs (2.1kg)	4.6lbs (2.1kg)
<b>Part Number</b>	103	103A	103X	133

## Medium Duty Mixers

- Durable and rugged multi-purpose mixers
- Wide range of speeds
- Moderate torque

The 104 models are medium duty, multi-purpose mixers that offer more power. All of these units offer two mixing shafts for versatility. The high speed drive shaft mixes emulsions. The low speed drive shaft handles high viscosity mixing. Mixers include collet chuck and 8" (20.3cm) mounting rod with carriage bolt and wrench for mounting motor to support stands. An additional clamp (110B or 112) is required to attach the motor's mounting rod to a support stand. Support stands and holders sold separately (see page 145).



**Model 104**

- Table mounted Basic Speed Control
- The speed control is remotely attached by a 42" (107cm) cord
- Dual shafts add versatility



**Model 104A**

- Top mounted Basic Speed Control
- Compact design saves space
- Dual shafts add versatility



**Model 104X**

- Economic dual shaft mixer without speed control
- Outfitted with an on/off switch
- Speeds of 7500 or 750rpm
- Adjusta-Speed Control (part number 115 upgrade available for this model (sold separately, see page 123)

**Recommended accessory shafts:**

All 5/16" accessory shafts

**Recommended accessory shafts:**

All 5/16" accessory shafts

**Recommended accessory shafts:**

All 5/16" accessory shafts

Specifications			
Model	104	104A	104X
Horsepower	1/18	1/18	1/18
Speed Range			
Direct Drive	1000 to 7500rpm	1000 to 7500rpm	7500rpm
10:1	100 to 750rpm	100 to 750rpm	750rpm
Torque			
Direct Drive	0.5 in-lbs	0.5 in-lbs	0.5 in-lbs
10:1	4.7 in-lbs	4.7 in-lbs	4.7 in-lbs
Electrical	120 volt, 1.1 amps	120 volt, 1.1 amps	120 volt, 1.1 amps
Shaft Size	5/16" (7.9mm)	5/16" (7.9mm)	5/16" (7.9mm)
Chuck Type	Collet	Collet	Collet
Overall Dimensions (L x W x H)	6.5 x 8.5 x 4" (16.5 x 21.6 x 10.2cm)	6.5 x 8.5 x 7" (16.5 x 21.6 x 17.8cm)	6.5 x 8.5 x 4" (16.5 x 21.6 x 10.2cm)
Ship Weight	5.1lbs (2.3kg)	5.1lbs (2.3kg)	5.1lbs (2.3kg)
Part Number	104	104A	104X



## Medium Duty Mixers

- Direct drive
- Brushless motors
- Fan cooled

The 107 models are comprised of a single shaft construction to maintain quiet mixing. This product line mixes large amounts of low viscous solutions when equipped with two Model 152A propellers. Both models have a continuous duty rating. Mixers include collet chuck and 8" (20.3cm) mounting rod with carriage bolt and wrench for mounting motor to support stands. An additional clamp (110B or 112) is required to attach the motor's mounting rod to a support stand. Support stands and holders sold separately (see page 145).

**Model 107**

- An economical mixer with a fixed speed of 1600rpm
- Utilizes an on/off switch
- Ideal for batch mixing
- Adjusta-Speed Control (part number 115) upgrade available for this model (sold separately, see page 123)

**Recommended accessory shafts:**

151, 152, 153B, 156, 166

**Model 107SC**

- Table mounted Basic Speed Control
- The speed control is remotely attached by a 42" (107cm) cord
- Offers a variable speed option
- Useful for working under a fume hood

**Recommended accessory shafts:**

151, 152, 153B, 156, 166

Specifications		
Model	107	107SC
Horsepower	1/30	1/30
Speed Range		
Direct Drive	1600rpm	100 to 1600rpm
10:1	N/A	N/A
Torque		
Direct Drive	1.3 in-lbs	1.3 in-lbs
10:1	N/A	N/A
Electrical	120 volt, 1.2 amps	120 volt, 1.2 amps
Shaft Size	5/16" (7.9mm)	5/16" (7.9mm)
Chuck Type	Collet	Collet
Overall Dimensions (L x W x H)	5.5 x 5.5 x 4" (13.4 x 13.4 x 10.2cm)	5.5 x 5.5 x 4" (13.4 x 13.4 x 10.2cm)
Ship Weight	4.6lbs (2.1kg)	4.6lbs (2.1kg)
Part Number	107	107SC

## Heavy Duty Mixers

- Durable and rugged, extremely versatile high viscosity mixers
- High torque
- Maintains constant speed

This product line offers the power and versatility required for viscous mixing. Heavy-Duty Mixers offer higher horsepower and greater torque over available speed ranges for difficult mixing jobs. Each mixer maintains constant speed even when the viscosity changes. Mixers are fitted with an adjustable Jacobs style chuck that accepts any accessory shaft. Mixers include adjustable chuck and 8" (20.3cm) mounting rod with carriage bolt and wrench for mounting motor to support stands. An additional clamp (110B or 112) is required to attach the motor's mounting rod to a support stand. Support stands and holders sold separately (see page 145).



### Model 134-1

- Top mounted Standard Speed Control
- Heavy-duty power at an economical price
- Offers higher torque over a wide speed range
- Perfect for mixing emulsions that require high speed and torque
- Mixes light oils at speeds of 50 to 750rpm

### Model 134-2

- Top mounted Standard Speed Control
- Features a unique triple shaft design
- Extremely powerful and versatile
- Offers high torque for slow speed mixing
- Mixes small quantities of high viscosity materials

Recommended accessory shafts: All

Recommended accessory shafts: All

Specifications		
Model	134-1	134-2
Horsepower	1/18	1/18
Speed Range		
Direct Drive	500 to 7500rpm	500 to 7500rpm
10:1	50 to 750rpm	50 to 750rpm
60:1	N/A	10 to 125rpm
Torque		
Direct Drive	0.5 in-lbs	0.5 in-lbs
10:1	4.7 in-lbs	4.7 in-lbs
60:1	N/A	15 in-lbs
Electrical	120 volt, 1.1 amps	120 volt, 1.1 amps
Shaft Size	5/16" (7.9mm)	5/16" (7.9mm)
Chuck Type	Adjustable	Adjustable
Overall Dimensions (L x W x H)	6.5 x 8.5 x 7" (16.5 x 21.6 x 17.8cm)	6.5 x 8.5 x 7" (16.5 x 21.6 x 17.8cm)
Ship Weight	5.1lbs (2.3kg)	5.1lbs (2.3kg)
Part Number	134-1	134-2

## Heavy Duty Mixers

- Powerful permanent magnet gear motors
- Maintains constant speed
- High torque

Powerful DC permanent magnet motors deliver power and reliability for high viscosity mixing. Each mixer maintains constant speed even when the viscosity changes. The mixers are fitted with an adjustable Jacobs style chuck that accepts any accessory shaft. Model 138 (238) and 4136 mixers include collet and adjustable chucks and 8" (20.3cm) mounting rod with carriage bolt and wrench for mounting motor to support stands. An additional clamp (110B or 112) is required to attach the motor's mounting rod to a support stand. The model 409 (429) mixer includes adjustable chuck, model 112 heavy-duty holder, and 8" (20.3cm) mounting rod for mounting motor to support stands. Support stands and holders sold separately (see page 145).

**Model 138 (238)**

- Top mounted Standard Speed Control
- This dual shaft mixer offers high torque at all speeds
- Dual shafts add versatility
- Features a permanent magnet and high output motor

Recommended accessory shafts: All

**Model 4136**

- Top mounted Standard Speed Control
- Ideal for difficult applications
- This dual shaft mixer contains multiple speed ranges with excellent torque
- Features a permanent magnet and high output motor
- Mixes high viscous materials like oils, grease, and gels

Recommended accessory shafts: All

**Model 409 (429)**

- Top mounted Standard Speed Control
- The powerhouse of Overhead Mixers
- This single shaft mixer creates maximum torque
- Features permanent magnet and high output motor
- The perfect unit for mixing tar and epoxy-like materials

Recommended accessory shafts: All

Specifications			
Model	138 (238)	4136	409 (429)
Horsepower	1/8	1/6	1/4
Speed Range			
Direct Drive	500 to 7500rpm	1000 to 5000rpm	50 to 500rpm
10:1	50 to 750rpm	100 to 500rpm	N/A
Torque			
Direct Drive	1.2 in-lbs	1.5 in-lbs	25 in-lbs
10:1	12 in-lbs	15 in-lbs	N/A
Electrical	120 volt, 2.2 amps 230 volt, 2.2 amps	120 volt, 2.5 amps N/A	120 volt, 1.8 amps 230 volt, 1.8 amps
Shaft Size	5/16" (7.9mm)	5/16" (7.9mm)	3/4" (19mm)
Chuck Type	Collet and Adjustable	Collet and Adjustable	Adjustable
Overall Dimensions (L x W x H)	6.5 x 8.5 x 7" (16.5 x 21.6 x 17.8cm)	6.5 x 8.5 x 7" (16.5 x 21.6 x 17.8cm)	6.5 x 8.5 x 7" (16.5 x 21.6 x 17.8cm)
Ship Weight	6.3lbs (2.9kg)	6.3lbs (2.9kg)	5.1lbs (2.3kg)
Part Number	138 (120V) 238 (230V)	4136 (120V)	409 (120V) 429 (230V)

## Accessories

### Collet Chuck

Stainless steel precision collet type chuck is used when the motor shaft and accessory shaft are the same diameter. It is true running and is the preferred choice when running at high speeds.

Description	Part Number
Fits 1/4" (6.4mm) diameter motor shafts	192
Fits 5/16" (7.9mm) diameter motor shafts	193



192

### Adjustable Chuck

Should be ordered based on the diameter of the motor shaft you are using. Each adjustable Jacobs style chuck can accommodate accessory shafts from 1/16" to 3/8" diameter. These products include a chuck key.

Description	Part Number
Fits 1/4" (6.4mm) diameter motor shafts	191C
Fits 5/16" (7.9mm) diameter motor shafts	191D
Fits 3/4" (19mm) diameter motor shafts	191L



191C

### Glass Rod Chuck

Holds glass mixing rods. It eliminates wobbling and vibration problems associated with glass mixing rods. This chuck accepts 1/4", 5/16", or 3/8" diameter motor shafts. It is equipped with nylon inserts needed for 0.24", 0.31" and 0.39" diameter mixing rods.

Description	Part Number
Fits 1/4" (6.4mm) diameter motor shafts	199A
Fits 5/16" (7.9mm) diameter motor shafts	199B
Fits 3/8" (9.5mm) diameter motor shafts	199C



199A

### Standard Support Holder

Has a strong stainless steel construction. It is equipped with oversized, easy to grip knobs for precise tightening. It also accommodates 1/2" (12.7mm) diameter shaft of a motor mounting rod and 5/8" (16mm) diameter support stand rod.

Description	Part Number
Standard Support Holder	110B



110B

### Heavy-Duty Holder

For mounting stirrers and other apparatus. Holder is constructed of strong aluminum alloy; fitted with oversized knobs for very secure positioning. Rods supported on 102mm (4") long surface to avoid vibration and wobble.

Material	Min. to Max. Grip Size	Part Number
Aluminum	0.24 to 0.95" (6 to 24mm)	112



112

## Accessories

**Propeller Shafts**

All stainless steel 303/304 are constructed with 15° pitched blades which creates an axial flow. Various shaft lengths and diameters with permanent 2" or 3.5" 3-blade propeller for every mixing need available. PTFE coating available.

**2" Propeller Shafts, Stainless Steel**

Blade Dia.	Shaft Dia.	Shaft Length	Part Number
2" (51mm)	1/4" (6.4mm)	12" (305mm)	150
2" (51mm)	1/4" (6.4mm)	18" (457mm)	150L
2" (51mm)	1/4" (6.4mm)	24" (610mm)	150XL
2" (51mm)	5/16" (7.9mm)	12" (305mm)	151
2" (51mm)	5/16" (7.9mm)	18" (457mm)	151L
2" (51mm)	5/16" (7.9mm)	24" (610mm)	151XL

**2" Propeller Shafts, PTFE Coated**

Blade Dia.	Shaft Dia.	Shaft Length	Part Number
2" (51mm)	1/4" (6.4mm)	12" (305mm)	150T
2" (51mm)	1/4" (6.4mm)	18" (457mm)	150LT
2" (51mm)	1/4" (6.4mm)	24" (610mm)	150XLT
2" (51mm)	5/16" (7.9mm)	12" (305mm)	151T
2" (51mm)	5/16" (7.9mm)	18" (457mm)	151LT
2" (51mm)	5/16" (7.9mm)	24" (610mm)	151XLT

**3.5" Propeller Shafts, Stainless Steel**

Blade Dia.	Shaft Dia.	Shaft Length	Part Number
3.5" (89mm)	5/16" (7.9mm)	12" (305mm)	152
3.5" (89mm)	5/16" (7.9mm)	18" (457mm)	152L
3.5" (89mm)	5/16" (7.9mm)	24" (610mm)	152XL
3.5" (89mm)	5/16" (7.9mm)	30" (762mm)	152XXL
3.5" (89mm)	3/8" (9.5mm)	12" (305mm)	154
3.5" (89mm)	3/8" (9.5mm)	18" (457mm)	154L
3.5" (89mm)	3/8" (9.5mm)	24" (610mm)	154XL
3.5" (89mm)	3/8" (9.5mm)	30" (762mm)	154XXL

**3.5" Propeller Shafts, PTFE Coated**

Blade Dia.	Shaft Dia.	Shaft Length	Part Number
3.5" (89mm)	5/16" (7.9mm)	12" (305mm)	152T
3.5" (89mm)	5/16" (7.9mm)	18" (457mm)	152LT
3.5" (89mm)	5/16" (7.9mm)	24" (610mm)	152XLT
3.5" (89mm)	5/16" (7.9mm)	30" (762mm)	152XXLT
3.5" (89mm)	3/8" (9.5mm)	12" (305mm)	154T
3.5" (89mm)	3/8" (9.5mm)	18" (457mm)	154LT
3.5" (89mm)	3/8" (9.5mm)	24" (610mm)	154XLT
3.5" (89mm)	3/8" (9.5mm)	30" (762mm)	154XXLT

**NOTE:** Additional and custom sizes are available. Call customer service for more information.



### Propeller Blades

Made of stainless steel. You can customize the propeller to the shaft of your choice. Several blades can be attached for increased agitation. Creates axial flow. Blades come on a bushing with a stainless steel hex-head screw and Allen key for attaching to mixing shafts.

Blade Dia.	Fits Shaft Dia.	Part Number
1" (25mm)	1/4" (6.4mm)	987406
2" (51mm)	1/4" (6.4mm)	153A
2" (51mm)	5/16" (7.9mm)	153B
3.5" (89mm)	5/16" (7.9mm)	152A
3.5" (89mm)	3/8" (9.5mm)	154A



987406

### High Speed Dispersion Blades

Designed for high speed dispersion. These blades tear particles apart and disperse them uniformly throughout the sample. Constructed of stainless steel with welded bushing and a set screw for mounting on mixer shafts.

Blade Dia.	Fits Shaft Dia.	Part Number
3" (76mm)	5/16" (7.9mm)	987407
3" (76mm)	3/8" (9.5mm)	987408



987407

### Mixing Shafts

Made of stainless steel. Can add propeller blades to these shafts to customize a propeller shaft. Increase agitation with multiple blades on one shaft.

Blade Dia.	Shaft Length	Part Number
1/4" (6.4mm)	6" (152mm)	180
1/4" (6.4mm)	12" (305mm)	180A
1/4" (6.4mm)	18" (457mm)	180L
1/4" (6.4mm)	24" (610mm)	180XL
1/4" (6.4mm)	30" (762mm)	180XXL
1/4" (6.4mm)	36" (914mm)	180XXXL
5/16" (7.9mm)	6" (152mm)	181
5/16" (7.9mm)	12" (305mm)	181A
5/16" (7.9mm)	18" (457mm)	181L
5/16" (7.9mm)	24" (610mm)	181XL
5/16" (7.9mm)	30" (762mm)	181XXL
5/16" (7.9mm)	36" (914mm)	181XXXL
3/8" (9.5mm)	6" (152mm)	182
3/8" (9.5mm)	12" (305mm)	182A
3/8" (9.5mm)	18" (457mm)	182L
3/8" (9.5mm)	24" (610mm)	182XL
3/8" (9.5mm)	30" (762mm)	182XXL
3/8" (9.5mm)	36" (914mm)	182XXXL



180

## Accessories

**Extension Sleeves**

Comprised of precision bored stainless steel tubing. Mixing paddles are joined to shafts of the same diameter to increase the paddle length. You can connect the mixing paddle directly to the motor shaft by using the extension sleeve in place of a chuck. Extension sleeve is 3 inches long.

Description	Part Number
Fits 1/4" (6.4mm) Diameter Motor Shafts	170
Fits 5/16" (7.9mm) Diameter Motor Shafts	171
Fits 3/8" (9.5mm) Diameter Motor Shafts	172



170

**Swivel Blade Paddles**

Mixes the contents of narrow-mouthed vessels. Creates radial flow. Constructed of durable stainless steel. Swivel blade is attached to the shaft. The blade measures 2W x 0.5H" (51 x 13mm)

Blade Dia.	Shaft Length	Part Number
1/4" (6.4mm)	12" (305mm)	165
1/4" (6.4mm)	18" (457mm)	165L
1/4" (6.4mm)	24" (610mm)	165XL
5/16" (7.9mm)	12" (305mm)	166
5/16" (7.9mm)	18" (457mm)	166L
5/16" (7.9mm)	24" (610mm)	166XL
3/8" (9.5mm)	12" (305mm)	167
3/8" (9.5mm)	18" (457mm)	167L
3/8" (9.5mm)	24" (610mm)	167XL



165

**Chain Paddles**

An efficient option for mixing the contents of narrow-necked containers. Fits openings as small as 5/8" (15.9mm). Blends suspensions and mixes both low and high viscosity liquids. Constructed entirely of stainless steel. Shafts vary in diameter and length. Swing diameter of chain is approximately 3" (76mm).

Blade Dia.	Shaft Length	Part Number
1/4" (6.4mm)	12" (305mm)	155
1/4" (6.4mm)	18" (457mm)	155L
1/4" (6.4mm)	24" (610mm)	155XL
5/16" (7.9mm)	12" (305mm)	156
5/16" (7.9mm)	18" (457mm)	156L
5/16" (7.9mm)	24" (610mm)	156XL
3/8" (9.5mm)	12" (305mm)	157
3/8" (9.5mm)	18" (457mm)	157L
3/8" (9.5mm)	24" (610mm)	157XL



155

## Accessories

### Beater Paddles

Designed for high torque, heavy-duty mixers. Paddle design inhibits incorporation of air, making it suitable for stirring shampoos and other foaming liquids. Constructed of stainless steel and available with PTFE coating. Creates radial flow. Small paddle blade is 4.5L x 3W" (114.3 x 76.2mm), large paddle blade is 5.5L x 4W" (139.7 x 101.6mm).

Material	Shaft Dia.	Shaft Length	Part Number
Small, Stainless Steel	5/16" (7.9mm)	12" (305mm)	162S
Small, Stainless Steel	5/16" (7.9mm)	18" (457mm)	162SL
Large, Stainless Steel	5/16" (7.9mm)	12" (305mm)	162
Large, Stainless Steel	5/16" (7.9mm)	18" (457mm)	162L
Large, Stainless Steel	5/16" (7.9mm)	24" (610mm)	162XL
Small, PTFE Coated	5/16" (7.9mm)	12" (305mm)	162ST
Small, PTFE Coated	5/16" (7.9mm)	18" (457mm)	162SLT
Large, PTFE Coated	5/16" (7.9mm)	12" (305mm)	162T
Large, PTFE Coated	5/16" (7.9mm)	18" (457mm)	162LT
Large, PTFE Coated	5/16" (7.9mm)	24" (610mm)	162XLT



162S

### U-Shaped Paddles

Designed for high viscosity materials or large batch mixing. Constructed of stainless steel and available with PTFE coating. Creates radial flow. Recommended for high torque, heavy-duty mixers. Paddle blade is 4.5L x 4.5W" (114 x 114mm) except 987415 4.5L x 3.5" (114 x 89mm).

Material	Shaft Dia.	Shaft Length	Part Number
Stainless Steel	3/8" (9.5mm)	18" (457mm)	987409
Stainless Steel	3/8" (9.5mm)	24" (610mm)	987410
Stainless Steel	3/8" (9.5mm)	24" (610mm)	987415
PTFE Coated	3/8" (9.5mm)	18" (457mm)	987411
PTFE Coated	3/8" (9.5mm)	24" (610mm)	987412



987409

### Square Paddles

Paddle blade is 2L x 2W" (51 x 51mm).

Material	Shaft Dia.	Shaft Length	Part Number
Stainless Steel	3/8" (9.5mm)	24" (610mm)	987418

### Solid Glass Mixer Paddles

Ideal for very sensitive samples. Constructed of chemical-resistant borosilicate glass that has been precision ground and polished. Creates radial flow. Requires Glass Rod Chuck to attach to mixer (see page 118).

Size	Shaft Dia.	Shaft Length	Part Number
2.5" (64mm)	3/8" (9.5mm)	12" (305mm)	987420
2.5" (64mm)	3/8" (9.5mm)	18" (457mm)	987421
2.5" (64mm)	3/8" (9.5mm)	24" (610mm)	987422
3.5" (89mm)	3/8" (9.5mm)	12" (305mm)	987423
3.5" (89mm)	3/8" (9.5mm)	18" (457mm)	987424
3.5" (89mm)	3/8" (9.5mm)	24" (610mm)	987425



987420

Don't see the length of the shaft you need? Give us a call, we have other sizes in stock.



## Accessories

**Zig-Zag Paddles**

Constructed of stainless steel and designed for durability. The zig-zag shape of this rod promotes mixing of heavy fluids like paints, pastes, and creams. Available in different shaft diameters and lengths. Also available with PTFE coating.

Material	Shaft Dia.	Shaft Length	Part Number
Stainless Steel	1/4" (6.4mm)	12" (305mm)	160
Stainless Steel	1/4" (6.4mm)	18" (457mm)	160L
Stainless Steel	1/4" (6.4mm)	24" (610mm)	160XL
Stainless Steel	5/16" (7.9mm)	12" (305mm)	161
Stainless Steel	5/16" (7.9mm)	18" (457mm)	161L
Stainless Steel	5/16" (7.9mm)	24" (610mm)	161XL
PTFE Coated	1/4" (6.4mm)	12" (305mm)	160T
PTFE Coated	1/4" (6.4mm)	18" (457mm)	160LT
PTFE Coated	1/4" (6.4mm)	24" (610mm)	160XLT
PTFE Coated	5/16" (7.9mm)	12" (305mm)	161T
PTFE Coated	5/16" (7.9mm)	18" (457mm)	161LT
PTFE Coated	5/16" (7.9mm)	24" (610mm)	161XLT



160

**Coil Impellers**

Constructed of stainless steel and designed for durability. Creates radial flow. The rotating coils force the solution outward from the coil, creating a vacuum that pulls the particles through the coil, effectively reducing and dispersing the sample. Ideal for dissolving powders.

**Bow-Tie Coils:** Ideal for lower viscosity fluids

**Straight Coils:** Ideal for higher viscosity materials and larger solids

Coil Type	Coil Length	Shaft Dia.	Shaft Length	Part Number
Bow-Tie	1.5" (38mm)	5/16" (7.9mm)	12" (305mm)	987426
Bow-Tie	2.5" (64mm)	5/16" (7.9mm)	12" (305mm)	987427
Bow-Tie	3.5" (89mm)	3/8" (9.5mm)	12" (305mm)	987428
Bow-Tie	4.5" (114mm)	3/8" (9.5mm)	18" (457mm)	987429
Straight	1.5" (38mm)	5/16" (7.9mm)	12" (305mm)	987430
Straight	2.5" (64mm)	5/16" (7.9mm)	12" (305mm)	987431
Straight	3.5" (89mm)	3/8" (9.5mm)	12" (305mm)	987432
Straight	4.5" (114mm)	3/8" (9.5mm)	18" (457mm)	987433



987426

**Adjusta-Speed Control**

Excellent upgrade for units with no speed control. Solid state, electronic, voltage control varies speed steplessly over the motor's range. Ideal for use with models 105, 103X, 104X, and 107.

Description	Part Number
Adjusta-Speed Control	115



115





1309



# LABJAWS

The unique design of these clamps, rods and supports, connectors, and accessories, conceivably offers one of the most extensive selections in the industry. With a variety of sizes, materials, hardware, and designs, there is always an option to accommodate any application.

- **Clamps firmly grip lab apparatus**
- **Ergonomic designs**
- **Durable, heavy-duty parts**
- **Built to last**

The following are many options to consider when choosing the right clamp to suit your needs:

#### **Material:**

A majority of the LabJaws clamps are made of nickel-plated zinc which possess a high tensile strength paired with an economical price. Stainless steel is an option that offers higher chemical resistance and durability. Aluminum is another material that is used in some of the products to offer a greater strength with a lighter weight.

#### **Configuration:**

Multi-purpose extension clamps allow placement of apparatus at various distances from a lab-frame. They are constructed with round extension arms, which allow the clamps to be rotated 360°. Attachment to lab-frames and other apparatus is easily accomplished with a variety of holders that are purchased separately. See Connectors & Holders section of this catalog (pages 138–140). Other clamps such as the swivel, fixed position, and some of the specialty clamps, have a built-in holder for attaching to lab-frames or other apparatus at a closer distance to the support.

#### **Prong Type:**

Two-prong clamps are ideal for holding straight-sided apparatus such as burets, thermometers, beakers, and flask necks. Three-prong clamps are more versatile and have the added capability of holding irregularly shaped objects. Clamps are supplied with both non-slip vinyl sleeves and, for temperatures above 100°C, fiberglass covers.

#### **Prong Adjustment:**

Single adjust clamps are great for applications where limited jaw adjustment is required. One prong or “finger” is adjusted using a wing nut, while the other prong remains stationary. Dual adjust clamps offer a greater flexibility because both prongs are adjustable over a wider range. Thumbscrews are utilized for easier prong adjustment.

#### **Holders and Connectors:**

A variety of holders and connectors are available to secure apparatus specific to the different angles, diameters, and weights in your application allowing you to customize as needed.

#### **Lab-Frames:**

LabJaws offers a complete choice of standard and custom frames and rods. Corrosion resistant frames and rods are available in aluminum, fiberglass, and stainless steel. Individual rods are available in standard lengths from 1.61 to 96" (41 to 2438mm). Standard lab-frame sets are available in five sizes. Combined with LabJaws accessories, these frames and rods can be adjusted to fit any need. Custom lab-frame designs are available to meet your exact requirements.

Depend on LabJaws for your custom mounting and sizing needs. Simply contact Talboys for personal design and fabrication assistance.

## Multi-Purpose Clamps

### UltraJaws Heavy-Duty Clamps

- Large grip adjustment range
- Single or dual adjust
- Available in three sizes; small, medium, and large
- Nickel-plated zinc

Talboys patented multi-purpose UltraJaws Heavy-Duty Clamps feature an innovative closed yoke construction that minimizes contamination and corrosion of internal components. The unique design enables secure gripping and positioning with added strength and durability.

Available in both single and dual prong adjustment, prongs open gradually to maximize grip size without binding. Both designs feature precise pressure regulation when gripping glassware surfaces to reduce the chance of breakage. UltraJaws clamps are constructed with extension rods for easy attachment to lab-frames and other apparatus. Supplied with non-slip vinyl sleeves and, for temperatures above 100°C, fiberglass covers.

The prong height of the UltraJaws Heavy-Duty Clamps make them ideal for use in holding and securing glassware with precision ground glass joints. The chart details which UltraJaws Clamps are recommended.

**NOTE:** An additional holder must be purchased in order to attach clamps to frames or other apparatus.

See the Connectors & Holders section of this catalog, pages 138-140.

Replacement vinyl and fiberglass sleeves are available, page 137.

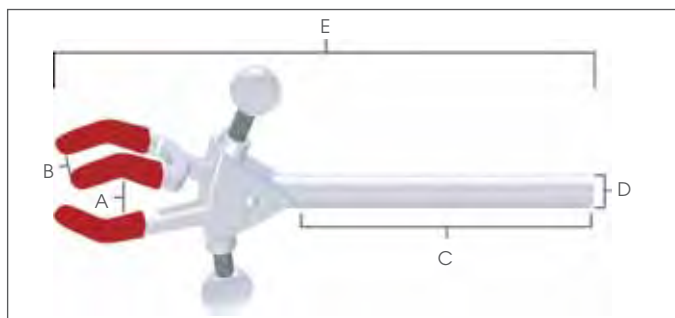

#### GROUND GLASS JOINT REFERENCE CHART

Clamp	Joint Size
Small Dual Adjust	10/30, 12/30, 14/20, 19/22, 24/40, 29/42, 34/45
Medium Dual Adjust	14/40, 19/38
Large Dual Adjust	45/50

### 3-Prong Single Adjust Clamps

Size	(A) Min. to Max Grip Size	(B) Prong Width	(C) Arm Length	(D) Arm Dia.	(E) Overall Length	Part Number
Small	0 to 23mm (0 to 0.91")	6mm (0.24")	102mm (4")	8mm (0.32")	162mm (6.38")	916114
Medium	0 to 50mm (0 to 1.97")	19mm (0.75")	127mm (5")	11mm (0.43")	229mm (9.02")	916112
Large	0 to 72mm (0 to 2.83")	29mm (1.14")	127mm (5")	11mm (0.43")	260mm (10.24")	916110

### 3-Prong Dual Adjust Clamps

Size	(A) Min. to Max Grip Size	(B) Prong Width	(C) Arm Length	(D) Arm Dia.	(E) Overall Length	Part Number
Small	0 to 32mm (0 to 1.26")	6mm (0.24")	102mm (4")	8mm (0.32")	152mm (5.98")	916113
Medium	0 to 70mm (0 to 2.76")	19mm (0.75")	127mm (5")	11mm (0.43")	222mm (8.74")	916111
Large	0 to 103mm (0 to 4.06")	29mm (1.14")	127mm (5")	11mm (0.43")	260mm (10.24")	916109

### Single Adjust Clamps



### Dual Adjust Clamps



## Multi-Purpose Clamps

## Heavy-Duty Tapered Clamps

Heavy-Duty, 4-prong, dual adjust tapered clamps are designed to hold large vessels with ground glass joint necks. Clamps are constructed with extension rods for easy attachment to lab-frames and other apparatus. Nickel-plated zinc construction.

**NOTE:** An additional holder must be purchased in order to attach clamps to frames or other apparatus.

See the Connectors & Holders section of this catalog, pages 138-140.



Size	Joint Size	Prong Width	Arm Length	Arm Dia.	Overall Length	Part Number
Small	24/40mm	16mm (0.63")	229mm (9.02")	13mm (0.51")	356mm (14")	915290
Large	34/45mm	19mm (0.75")	229mm (9.02")	13mm (0.51")	381mm (15")	915291

## Stainless Steel Multi-Purpose Clamps

- Stainless steel, electro-polished finish
- Large dual adjustment range
- Available in three sizes; small, medium, and large

These durable, multi-purpose clamps are made entirely of stainless steel with an electro-polished finish and offer excellent chemical resistance and overall strength. The versatile 3-prong design secures various lab apparatus such as jointed glassware, columns, flasks, and tubes. Dual prong adjustments offer a wide range of motion. Long stainless steel extension arm offers easy positioning and depth adjustment. Autoclavable. Supplied with non-slip vinyl sleeves and, for temperatures above 100°C, fiberglass covers.

**NOTE:** An additional holder must be purchased in order to attach clamps to frames or other apparatus.

See the Connectors & Holders section of this catalog, pages 138-140.

Replacement vinyl and fiberglass sleeves are available, page 137.

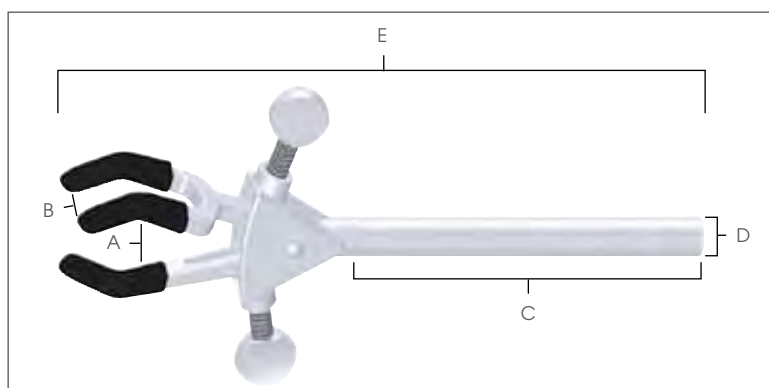

## 3-Prong Stainless Steel Dual Adjust Clamps

Size	(A) Min. to Max Grip Size	(B) Prong Width	(C) Arm Length	(D) Arm Dia.	(E) Overall Length	Part Number
Small	0 to 48mm (0 to 1.9")	13mm (0.51")	102mm (4")	10mm (0.39")	172mm (6.77")	916352
Medium	0 to 69mm (0 to 2.72")	19mm (0.75")	127mm (5")	13mm (0.51")	229mm (9.02")	916351
Large	0 to 102mm (0 to 4")	29mm (1.14")	127mm (5")	13mm (0.51")	273mm (10.75")	916350

## Multi-Purpose Clamps

### 3-Prong Multi-Purpose Clamps

- Large grip adjustment range
- 3-prong construction
- Single or dual adjust
- Nickel-plated zinc

Designed to securely hold every type of laboratory glassware and apparatus. Long, seamless nickel-plated brass tubing attaches clamp head securely and offers easy positioning in the deepest fume hoods. Clamps are constructed with round extension arms, which allow the clamps to be rotated 360°. Extension arms also allow placement of apparatus at various distances from lab-frames without compromising the integrity of your experiment. Supplied with non-slip vinyl sleeves and, for temperatures above 100°C, fiberglass covers.

**NOTE:** An additional holder must be purchased in order to attach clamps to frames or other apparatus.

See the Connectors & Holders section of this catalog, pages 138-140.

Replacement vinyl and fiberglass sleeves are available, page 137.

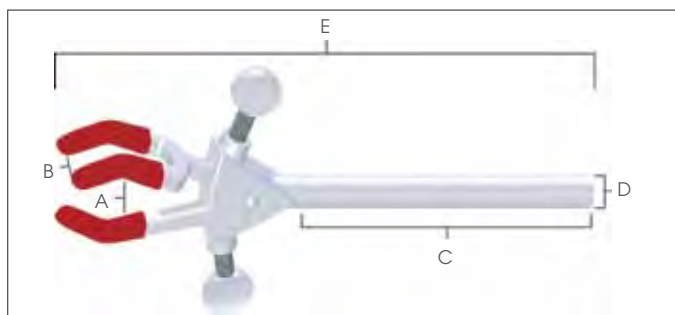

### 3-Prong Single Adjust Clamps



916057

916055

916053

### 3-Prong Dual Adjust Clamps



916056

916054

916052

### 3-Prong Single Adjust Clamps

Size	(A) Min. to Max Grip Size	(B) Prong Width	(C) Arm Length	(D) Arm Dia.	(E) Overall Length	Part Number
Small	0 to 39mm (0 to 1.54")	11mm (0.43")	102mm (4")	8mm (0.32")	160mm (6.3")	916057
Medium	0 to 71mm (0 to 2.8")	19mm (0.75")	127mm (5")	11mm (0.43")	218mm (8.58")	916055
Large	0 to 108mm (0 to 4.25")	29mm (1.14")	127mm (5")	11mm (0.43")	248mm (9.76")	916053

### 3-Prong Dual Adjust Clamps

Size	(A) Min. to Max Grip Size	(B) Prong Width	(C) Arm Length	(D) Arm Dia.	(E) Overall Length	Part Number
Small	0 to 46mm (0 to 1.81")	11mm (0.43")	102mm (4")	8mm (0.32")	168mm (6.61")	916056
Medium	0 to 69mm (0 to 2.72")	19mm (0.75")	127mm (5")	11mm (0.43")	229mm (9.02")	916054
Medium (extended)	0 to 69mm (0 to 2.72")	19mm (0.75")	305mm (12")	13mm (0.5")	406mm (16")	916370
Large	0 to 105mm (0 to 4.13")	29mm (1.14")	127mm (5")	11mm (0.43")	273mm (10.75")	916052
Large (extended)	0 to 105mm (0 to 4.13")	29mm (1.14")	305mm (12")	13mm (0.5")	451mm (17.76")	916371



## Multi-Purpose Clamps

## 2-Prong Multi-Purpose Clamps

- Stainless steel electro-polished finish or nickel-plated zinc
- Large grip adjustment range
- 2-prong construction
- Single or dual adjust

Designed to securely hold laboratory glassware and apparatus. Extension arm attaches clamp head securely and offers easy positioning in the deepest fume hoods. Clamps are constructed with round extension arms, which allow the clamps to be rotated 360°. Extension arms also allow placement of apparatus at various distances from lab-frames without compromising the integrity of your experiment. Stainless steel clamps are electro-polished and made entirely of stainless steel. They offer exceptional chemical resistance and are autoclavable. Nickel-plated zinc offers a clamp with a high tensile strength at an economical price. Supplied with non-slip vinyl sleeves and, for temperatures above 100°C, fiberglass covers.

**NOTE:** An additional holder must be purchased in order to attach clamps to frames or other apparatus.

See the Connectors & Holders section of this catalog, pages 138-140.

Replacement vinyl and fiberglass sleeves are available, page 137.

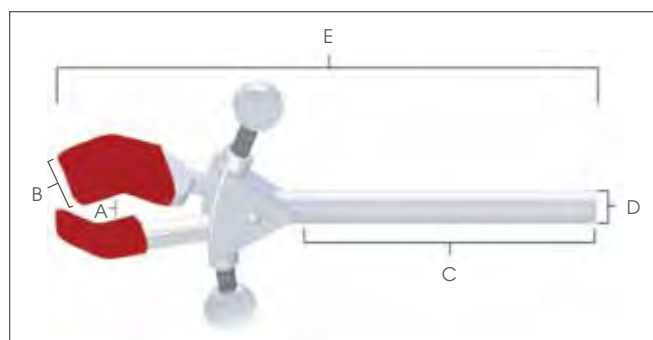

## 2-Prong Single Adjust Clamps



916060

## 2-Prong Dual Adjust Clamps

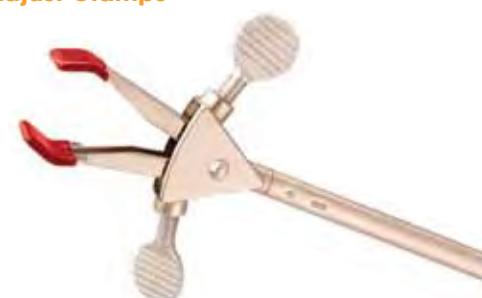

916058

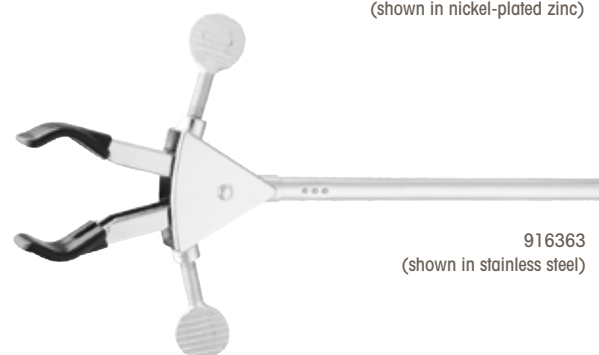
916061  
(shown in nickel-plated zinc)916363  
(shown in stainless steel)

## 2-Prong Single Adjust Clamps

Material	Size	(A) Min. to Max Grip Size	(B) Prong Width	(C) Arm Length	(D) Arm Dia.	(E) Overall Length	Part Number
Nickel-plated zinc	Medium	0 to 78mm (0 to 3.07")	23mm (0.91")	127mm (5")	11mm (0.43")	216mm (8.5")	916060
Nickel-plated zinc	Large	0 to 92mm (0 to 3.62")	23mm (0.91")	127mm (5")	11mm (0.43")	229mm (9.02")	916058

## 2-Prong Dual Adjust Clamps

Material	Size	(A) Min. to Max Grip Size	(B) Prong Width	(C) Arm Length	(D) Arm Dia.	(E) Overall Length	Part Number
Stainless steel	Medium	0 to 75mm (0 to 2.95")	23mm (0.91")	127mm (5")	11mm (0.43")	229mm (9.02")	916360
Nickle-plated zinc	Medium	0 to 75mm (0 to 2.95")	23mm (0.91")	127mm (5")	11mm (0.43")	229mm (9.02")	916061
Stainless steel	Large	0 to 95mm (0 to 3.74")	23mm (0.91")	127mm (5")	11mm (0.43")	248mm (9.76")	916363
Nickle-plated zinc	Large	0 to 95mm (0 to 3.74")	23mm (0.91")	127mm (5")	11mm (0.43")	248mm (9.76")	916059

## Multi-Purpose Clamps

### Swivel Clamps

Used to hold apparatus near the lab-frame. Unlike extension clamps, the swivel clamps have an integral holder for attaching to a lab-frame or other apparatus. Built-in holder grips rods up to 19mm (0.75") in diameter and is adjustable for forward or reverse-facing adjustment screws. Shaft wing-nut allows the holding angle of the swivel clamp to adjust through 360° of rotation and can be locked in place once desired position is achieved. Stainless steel electro-polished finish or nickel-plated zinc construction. Supplied with non-slip vinyl sleeves and, for temperatures above 100°C, fiberglass covers.

**NOTE:** Replacement vinyl and fiberglass sleeves are available, page 137.

916365  
(shown in stainless steel)



916068  
(shown in nickel-plated zinc)



Material	Description	Size	Min. to Max. Grip Size	Prong Width	Overall Length	Part Number
Stainless steel	2-Prong Single Adjust	Medium	0 to 76mm (0 to 3")	23mm (0.91")	163mm (6.42")	916366
Nickel-plated zinc	2-Prong Single Adjust	Medium	0 to 76mm (0 to 3")	23mm (0.91")	163mm (6.42")	916067
Nickel-plated zinc	2-Prong Single Adjust	Large	0 to 95mm (0 to 3.74")	23mm (0.91")	180mm (7.09")	916068
Stainless steel	3-Prong Dual Adjust	Medium	0 to 69mm (0 to 2.72")	20mm (0.79")	178mm (7.01")	916365
Nickel-plated zinc	3-Prong Dual Adjust	Medium	0 to 69mm (0 to 2.72")	20mm (0.79")	178mm (7.01")	916066

### Fixed-Position Clamps

Used to hold apparatus near the lab-frame where no adjustment is required after set-up. Built-in holder grips rods up to 19mm (0.75") in diameter. Fixed-Position Clamps have an integral holder but can be rotated after attachment to a lab-frame or other apparatus. Available in 2-prong or 3-prong. Stainless steel electro-polished finish or nickel-plated zinc construction. Supplied with non-slip vinyl sleeves and, for temperatures above 100°C, fiberglass covers.

**NOTE:** Replacement vinyl and fiberglass sleeves are available, page 137.

916369  
(shown in stainless steel)



916070  
(shown in nickel-plated zinc)



Material	Description	Size	Min. to Max. Grip Size	Prong Width	Overall Length	Part Number
Stainless steel	2-Prong Single Adjust	Medium	0 to 77mm (0 to 3.03")	23mm (0.91")	133mm (5.24")	916373
Nickel-plated zinc	2-Prong Single Adjust	Medium	0 to 77mm (0 to 3.03")	23mm (0.91")	133mm (5.24")	916070
Stainless steel	3-Prong Dual Adjust	Medium	0 to 69mm (0 to 2.72")	20mm (0.79")	146mm (5.75")	916369
Nickel-plated zinc	3-Prong Dual Adjust	Medium	0 to 69mm (0 to 2.72")	20mm (0.79")	146mm (5.75")	916069

### Double Jaw Utility Clamp

Swivels 360° and locks securely in desired position. These 2-prong clamps have a medium and a large clamp on each end. Nickel-plated zinc construction. Supplied with non-slip vinyl sleeves and, for temperatures above 100°C, fiberglass covers.

**NOTE:** Replacement vinyl and fiberglass sleeves are available, page 137.



916073

Description	Min. to Max. Grip Size	Prong Width	Overall Length	Part Number
Medium 2-Prong	0 to 76mm (0 to 3")	23mm (0.91")	222mm (8.74")	916073
Large 2-Prong	0 to 95mm (0 to 3.74")	23mm (0.91")	222mm (8.74")	916073

## Multi-Purpose Clamps

**Thermometer Swivel Clamp**

Holds glass tubes and thermometers 114mm (4.49") from support rod. Clamp features safety adjust spring plate jaws that adjust to any angle with locking wing-nut. Built-in holder grips rods up to 19mm (0.75") in diameter. Lightweight, rust, and corrosion-resistant. Nickel-plated construction.

Min. to Max. Grip Size	Overall Length	Part Number
6 to 8mm (0.24 to 0.32")	159mm (6.26")	916075



916075

**Thermometer / Thermocouple Extension Clamp**

Lightweight clamp holds glass tubing, thermometers or thermocouples up to 178mm (7") from support rod. Tightening wing-nut applies tension to the nickel-plated jaws.

**NOTE:** An additional holder must be purchased in order to attach clamps to frames or other apparatus.

See the Connectors & Holders section of this catalog, pages 138-140.

Min. to Max. Grip Size	Ext Arm Length	Arm Dia.	Overall Length	Part Number
6 to 12mm (0.24 to 0.47")	127mm (5")	11mm (0.43")	210mm (8.27")	916076

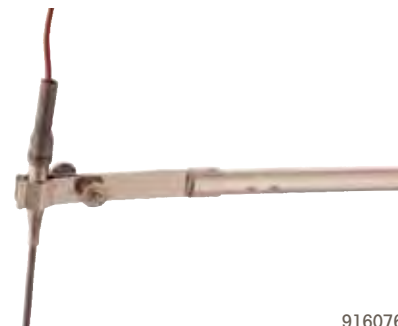

916076

**Wall Clamp**

Ideal for securing fermentation tubes, burets or other small objects to walls where no frames are available. Integral self-tapping screw secures clamp to wall. Nickel-plated construction.

Min. to Max. Grip Size	Overall Length	Part Number
5 to 10mm (0.2 to 0.39")	80mm (3.15")	916081



916081

**Water Bath Clamps**

Holds a variety of apparatus, including glass tubes and thermometers onto glass water bath walls. Built-in holder grips walls of varying thickness, up to 9mm (0.35"). Knurled thumbscrew tightens jaws to hold objects firmly. Nickel-plated zinc construction. Large water bath clamp is supplied with non-slip vinyl sleeves and, for temperatures above 100°C, fiberglass covers.

**NOTE:** Replacement vinyl and fiberglass sleeves are available, page 137.

Size	Min. to Max. Grip Size	Prong Width	Overall Length	Part Number
Small	5 to 10mm (0.2 to 0.39")	N/A	89mm (3.5")	916077
Large	0 to 46mm (0 to 1.81")	11mm (0.43")	117mm (4.61")	916078



916077



916078

## Specialty Clamps

For the items listed below an additional holder must be purchased in order to attach clamps to frames or other apparatus. See the Connectors & Holders section of this catalog, pages 138-140.

### Chain Clamps

Holds large round or irregular shaped objects firmly, yet gently, to lab-frames and rods. Quick and secure slip-on chain connection with large, easy-to-turn adjusting knob. Extension arm allows user to vary distance from the frame. Available as stainless steel clamp, constructed entirely of stainless steel with electro-polished finish or nickel-plated zinc clamp with strong, chromed-brass chain.

#### STAINLESS STEEL

Size	Min. to Max. Dia.	Ext. Arm Length	Arm Dia.	Overall Length	Part Number
Large-5	35 to 280mm (1.38 to 11.02")	127mm (5")	13mm (0.51")	206mm (8.11")	916364

#### NICKEL-PLATED ZINC

Size	Min. to Max. Dia.	Ext. Arm Length	Arm Dia.	Overall Length	Part Number
Small	35 to 170mm (1.38 to 6.69")	127mm (5")	13mm (0.51")	188mm (7.4")	916072
Large-5	35 to 280mm (1.38 to 11.02")	127mm (5")	13mm (0.51")	206mm (8.11")	916129
Large-12	35 to 280mm (1.38 to 11.02")	305mm (12")	13mm (0.51")	384mm (15.12")	916372



916364  
(shown in stainless steel)

### Column Clamps

These sturdy, easily adjusted, multi-purpose clamps are ideal for holding large cylindrical glassware and similar objects. A large, flat thumbscrew/worm-drive permits maximum tightening or removal in minimum time. Clamp is constructed of corrosion-resistant stainless steel. Ideal for chromatography columns.

Size	Min. to Max. Dia.	Ext. Arm Length	Arm Dia.	Overall Length	Part Number
Small	65 to 89mm (2.56 to 3.5")	211mm (8.31")	11mm (0.43")	282mm (11.1")	916188
Medium	91 to 114mm (3.58 to 4.49")	211mm (8.31")	11mm (0.43")	315mm (12.4")	916189
Large	64 to 140mm (2.52 to 5.51")	211mm (8.31")	11mm (0.43")	338mm (13.31")	916190
X-Large	92 to 165mm (3.62 to 6.5")	211mm (8.31")	11mm (0.43")	368mm (14.49")	916191



916190

### Nester Extension Clamps

Securely holds large or small glass distillation columns and odd-shaped glassware. Constructed of stainless steel with strong, chromed-brass band and chain.

Min. to Max. Dia.	Ext. Arm Length	Arm Dia.	Overall Length	Part Number
50 to 102mm (1.97 to 4")	152mm (5.98")	10mm (0.39")	262mm (10.32")	916192



916192

### PVC Coated Open Extension Rings

Ideal for supporting funnels, round bottom flasks, reaction vessels, and other apparatus that require lower support. Opening in PVC coated aluminum ring allows for easy removal of sample container. PVC coating protects glassware. Long extension arm permits depth adjustment of the open ring from the lab-frame or ring stand.

Ring Dia.	Ext. Arm Length	Arm Dia.	Overall Length	Part Number
76mm (3")	254mm (10")	9mm (0.35")	328mm (12.91")	916330
102mm (4")	305mm (12")	9mm (0.35")	404mm (15.91")	916331
127mm (5")	305mm (12")	11mm (0.43")	427mm (16.81")	916332



916331

### Open Rings

Lightweight rings mount funnels, boiling flasks, and other irregular shaped objects to lab-frames. Open ring section allows items to pass in and out of support area easily, reducing risk of breakage. Aluminum construction.

Ring Dia.	Ext. Arm Length	Arm Dia.	Overall Length	Part Number
76mm (3")	58mm (2.28")	9mm (0.35")	132mm (5.2")	916208
102mm (4")	58mm (2.28")	9mm (0.35")	158mm (6.22")	916209
127mm (5")	61mm (2.4")	11mm (0.43")	183mm (7.2")	916210



916210

## Specialty Clamps

## Buret Holders

Stainless steel electro-polished finish or nickel-plated zinc construction. Double Buret Clamp holds any size buret from micro to 100mL capacity. Simply compress the scissor-like mechanism, insert buret and gently release to grip. Numbers and graduation on buret remain easy to read. For height adjustments, recompress mechanism and slide buret up or down and gently release. Clamp unit with built-in reinforced hook connector attaches to optional standard support rod. Adjusting nut faces forward for easy use. Stainless steel or aluminum support rod attaches to optional porcelain base.

**Support Rod (Dia. x L):** 13 x 578mm (0.51 x 22.76")

**Porcelain Base (L x W x H):** 178 x 330 x 25mm (7 x 13 x 1")

## STAINLESS STEEL

Description	Part Number
Double Buret Clamp (only)	916367
Support Rod (only)	916347
Support Stand with Rod	916349
Double Buret Clamp & Support Stand with Rod (complete)	916348

## NICKEL-PLATED ZINC

Description	Part Number
Double Buret Clamp (only)	916071
Support Rod (only)	916228
Support Stand with Rod	916186
Double Buret Clamp & Support Stand with Rod (complete)	916187



916348  
(shown in stainless steel)

## Kettle Clamps

Holds flask and cover together firmly. Three insulated spring-activated clamping arms. Stainless steel springs. For use on reaction kettles.

Flask Size	Inside Dia.	Part Number
500mL, 1000mL	125mm (4.92")	971065
2000mL, 3000mL, 4000mL	142mm (5.59")	971066



971065

## Electrode Support Clamp

Permits suspension of electrodes over beaker for potentiometric titrations. Holds any electrode clamp at desired level. Built-in nickel-plated zinc holder grips rods up to 19mm (0.75") in diameter.

Overall Length	Part Number
178mm (7")	916079



916079  
Electrode holder not included

## Suspension Clamp

Holds thermometers, potash bulbs or drying tubes 114mm (4.49") from support rod. Machine tapered, nickel-plated brass hook won't bend, rust, or corrode. Built-in holder grips rods up to 19mm (0.75") in diameter.

Overall Length	Part Number
137mm (5.39")	916080



916080

## Support Clamp

Supports electrolysis apparatus, glass rods or tubing at any angle. Arms are nickel-plated brass with vinyl coating. Easily supports cylindrical objects up to 19mm (0.75") in diameter. Built-in holder grips rods up to 19mm (0.75") in diameter.

Overall Length	Prong Width	Part Number
152mm (5.99")	25mm (1")	916074



916074

## Specialty Clamps

Ultra Flex Support Systems have unique flexible arms that are extremely versatile and can be placed in virtually any position or angle. Ultra Flex comes in three different systems; base plate, lab-frame connector, and bench clamp. Each system includes a 2-Prong Clamp Head, 3-Prong Clamp Head, Spring Clamp Head, nickel-plated flex arm in 305mm (12") or 457mm (18") length, and utility wrench. 2-prong and 3-prong clamp heads also supplied with non-slip vinyl sleeves and, for temperatures above 100°C, fiberglass covers.

<b>Arm Length:</b>	Ultra Flex 12	305mm (12")
	Ultra Flex 18	457mm (18")
<b>Arm Diameter:</b>		13mm (0.51")
<b>Max. Grip Size:</b>	2-Prong Clamp Head	75mm (2.95")
	3-Prong Clamp Head	69mm (2.72")
	Spring Clamp Head	13mm (0.51")

2-Prong Clamp Head



3-Prong Clamp Head



Spring Clamp Head



### Ultra Flex Support System with Base Plate

Talboys Ultra Flex Support System with Base Plate is constructed of all metal and designed with a stable, painted steel base plate with chemical resistant black finish that fits easily on bench tops or in fume hoods. Base plate measures 127 x 127 x 12.7mm (5 x 5 x 0.5").

Description	Part Number
Ultra Flex 12 with Base Plate	916310
Ultra Flex 18 with Base Plate	916311



916311

### Ultra Flex Support System with Lab-Frame Connector

Ultra Flex Support System with Lab-Frame Connector securely attaches to support stands, lab-frames, or any support rod up to 19mm (0.75") in diameter. Ideal for use in fume hoods. Lab-frame connector is made of cast alloy.

Description	Part Number
Ultra Flex 12 with Lab-Frame Connector	916314
Ultra Flex 18 with Lab-Frame Connector	916315



916314

### Ultra Flex Support System with Bench Clamp

Ultra Flex Support System with Bench Clamp easily attaches to the side of your lab bench or counter top, which helps utilize more space in your lab. Bench clamp is constructed of aluminum.

Description	Part Number
Ultra Flex 12 with Bench Clamp	916312
Ultra Flex 18 with Bench Clamp	916313



916313

### Replacement Parts

Description	Part Number
2-Prong Clamp Head	916321
3-Prong Clamp Head	916322
Spring Clamp Head	916323
12" Flex Arm	916320
18" Flex Arm	916328
Base Plate	916324
Lab-Frame Connector	916326
Bench Clamp	916325

## Specialty Clamps &amp; Clamp Accessories

**Bench Clamp**

Aluminum bracket with arm fastens quickly and firmly to any convenient shelf. Accepts 13mm (0.51") rods vertically and horizontally, to which ordinary rings and clamps attach, leaving bench surface clear for apparatus.

Clamp Opening	Depth of Grip	Overall Length	Part Number
1.7" (43mm)	2" (51mm)	7.75" (197mm)	916185



916185

**Thumbscrew Knob**

Thumbscrew tightening knob features a 32mm (1.25") slot in the center of a nylon disc that will accept thumbscrews supplied with the LabJaws and UltraJaws Multi-Purpose Clamps, excluding the stainless steel version. Makes tightening of clamps easier on the hands and wrists.

Overall Diameter	Thumbscrew Slot	Part Number
64mm (2.5")	32mm (1.25")	915043



915043

**Replacement Sleeves**

Sleeves are easily removed for cleaning or replacement. Both vinyl and fiberglass sleeves are available. Fiberglass sleeves are recommended for applications above 100°C (212°F).



Clamp Size	Red Vinyl Sleeve Part Number	Black Vinyl Sleeve Part Number	Fiberglass Sleeve Part Number
Medium 2-Prong (2 pack)	916115	N/A	916116
Large 2-Prong (2 pack)	916117	N/A	916118
Small 3-Prong (3 pack)	916119	916249	916120
Medium 3-Prong (3 pack)	916121	916250	916122
Large 3-Prong (3 pack)	916123	916251	916124

## Connectors & Holders

### Regular Holder

Stainless steel electro-polished finish or nickel-plated zinc construction. Ideal for holding clamps to lab-frames. Use wherever clamping at 90° is required.

Material	Min. to Max. Grip Size	Part Number
Stainless steel	0 to 18mm (0 to 0.71")	916359
Nickel-plated zinc	0 to 18mm (0 to 0.71")	916051



916359  
(shown in stainless steel)



916051  
(shown in nickel-plated zinc)

### Jumbo Holder

Stainless steel electro-polished finish or aluminum construction. Ideal for holding clamps to lab-frames or ring stands.

Material	Min. to Max. Grip Size	Part Number
Stainless steel	0 to 21mm (0 to 0.83")	916357
Aluminum	0 to 21mm (0 to 0.83")	916050



916357  
(shown in stainless steel)



916050  
(shown in aluminum)

### Heavy-Duty Holder

For mounting stirrers and other apparatus. Holder is constructed of strong aluminum alloy; fitted with oversized knobs for very secure positioning. Rods supported on 102mm (4") long surface to avoid vibration and wobble.

Material	Min. to Max. Grip Size	Part Number
Aluminum	6 to 24mm (0.24 to 0.95")	112



112

### Swivel Holder

Two rod holders with center swivel capacity allow tilting of clamps at any angle in parallel planes. Outside adjustment screw allows close proximity between items being held. Stainless steel electro-polished or nickel-plated zinc construction.

Material	Min. to Max. Grip Size	Part Number
Stainless steel	0 to 19mm (0 to 0.75")	916368
Nickel-plated zinc	0 to 19mm (0 to 0.75")	916065



916368  
(shown in stainless steel)



916065  
(shown in nickel-plated zinc)

### All-Position Clamp Holder

Surpasses standard holding capabilities. The all-position clamp holder permits adjustment at any angle in any plane. Holders are set at 90° to each other, connected by a 90° connector, allowing 360° rotation. Nickel-plated zinc construction.

Material	Min. to Max. Grip Size	Part Number
Nickel-plated zinc	0 to 19mm (0 to 0.75")	916085

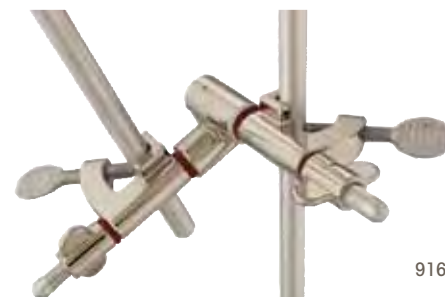

916085

### Clamp Holder

Clamp is ideal for gripping 2 rods at 90°. Oversized thumbscrews make securing rods fast and easy.

Material	Min. to Max. Grip Size	Overall Length	Part Number
Aluminum	0 to 17mm (0 to 0.66")	70mm (2.75")	916049



916049



## Connectors &amp; Holders

**Hook Connector**

Stainless steel electro-polished finish or nickel-plated zinc construction. Simple, versatile, and easy-to-use. Hook connectors allow one-handed assembly of two components with one adjustment screw.

Material	Min. to Max. Grip Size	Part Number
Stainless steel	0 to 13mm (0 to 0.51")	916358
Nickel-plated zinc	0 to 13mm (0 to 0.51")	916128

**End-to-End Connector**

Extend the length of lab-frame rods. Strong aluminum alloy connector permits end-to-end joining of rods. Precision boring of connector ensures perfect alignment of rods. Corrosion resistant. Comes with two set screws.

Material	Min. to Max. Grip Size	Part Number
Aluminum	0 to 13mm (0 to 0.51")	916133

**Rod End Connector**

Holds rods firmly at 90°. Use when semi-permanent installations are required. Comes with two set screws and is precision bored for close fit. Stainless steel electro-polished finish or nickel-plated zinc construction.

Material	Min. to Max. Grip Size	Part Number
Stainless steel	0 to 13mm (0 to 0.51")	916362
Nickel-plated zinc	0 to 13mm (0 to 0.51")	916126

**S-Connector**

Stainless steel electro-polished finish or nickel-plated zinc construction. Clamp is ideal for constructing lab-frames or other supports requiring the connection of two perpendicular rods. Clamp connects two 13mm (0.51") rods at a 90° angle and features separate adjustment screws for each rod location.

Material	Min. to Max. Grip Size	Part Number
Stainless steel	0 to 13mm (0 to 0.51")	916355
Nickel-plated zinc	0 to 13mm (0 to 0.51")	916127

**Frame Connector (Pack of 12)**

Improved contour delivers simplicity and strength. Angled adjustment screws allow easy set-up and prevents misalignment. Smooth, rounded surfaces are easy-to-clean. Small size maximizes lab-frame space. Bright dipped aluminum finish sealed with silicon for maximum protection against corrosion.

Material	Min. to Max. Grip Size	Part Number
Aluminum	0 to 13mm (0 to 0.51")	916125



### Universal Stirrer Mounting Bracket

Use to mount stirrers and other devices to lab-frames. Aluminum mounting bracket with attachment screws.

Max. Weight Mounted	Min. to Max. Grip Size	Part Number
2.27kg (5lbs)	0 to 20mm (0 to 0.78")	916134



916134

### Multi-Rod Connector

Maximum adjustment capability within one connector. Two adjustment rods fit into the oval hole in the connector, preventing turning when tightened. Side and front 13mm (0.51") holes allow creation of a variety of configurations. Nickel-plated zinc construction.

Min. to Max. Rod Size	Part Number
0 to 13mm (0 to 0.51")	916131



916131

### Wrench

Special adjusting wrench is for use with lab-frame items with set screws.

Length	Part Number
79mm (3.11")	916139



916139

### Channel Connector

Special connector fastens lab-frame rod to steel 41mm (1.61") channels. Loosen the connector and slide up or down for easy adjustment of rod position.

Dimensions	Part Number
33 x 40mm (1.3 x 1.58")	916130



916130

### Horizontal Mounting Bars with Coupler

Threaded end for direct installation into channels. Comes with spring coupler for use in steel 41mm (1.61") channels. Locking nut included. Use with steel channel frames.

Bar Length	Part Number
51mm (2")	916135
102mm (4")	916136
152mm (6")	916137
203mm (8")	916138



916137

## Lab-Frames

**Lab Frame Foot**

Stainless steel electro-polished finish or nickel-plated zinc construction. Strong, durable lab-frame foot is designed for mounting lab-frames permanently to bench tops, fume hoods, walls, and floors. Spilled fluids roll right off the smooth body contour, minimizing contamination and easing clean-ups. Features a set screw and includes three 19mm (0.75") mounting screws.

Material	Min. to Max. Grip Size	Dimensions (Dia. x H)	Part Number
Stainless steel	0 to 0.51" (0 to 13mm)	2.3 x 1.25" (58 x 32mm)	916356
Nickel-plated zinc	0 to 0.51" (0 to 13mm)	2.3 x 1.25" (58 x 32mm)	916132



916356  
(shown in stainless steel)

**Frame Rods**

Everything you need to customize a lab-frame to your laboratory space. Quality construction throughout. Frame rods are available in many lengths and materials.

**Aluminum**

Center-less ground for a precise fit. These hard aluminum rods provide a smooth fit with lab-frames. Corrosion resistant with chamfered ends for easy location.

**Fiberglass**

Strong and resilient fiberglass rods will not corrode or rust. Structurally strong and resilient to clamp compression scars.

**Stainless Steel**

Heavy-duty, top-of-the-line rods provide maximum strength and durability. Constructed of 303 stainless steel.



aluminum



fiberglass



stainless steel

Rod Diameter	Rod Length	Aluminum Part Number	Fiberglass Part Number	Stainless Steel Part Number
0.51" (13mm)	1.61" (41mm)	916140	916151	916162
0.51" (13mm)	2" (51mm)	916141	916152	916163
0.51" (13mm)	6" (152mm)	916142	916153	916164
0.51" (13mm)	12" (305mm)	916143	916154	916165
0.51" (13mm)	18" (457mm)	916144	916155	916166
0.51" (13mm)	24" (610mm)	916145	916156	916167
0.51" (13mm)	36" (914mm)	916146	916157	916168
0.51" (13mm)	48" (1219mm)	916147	916158	916169
0.51" (13mm)	60" (1524mm)	916148	916159	916170
0.51" (13mm)	72" (1829mm)	916149	916160	916171
0.51" (13mm)	96" (2438mm)	916150	916161	916172

## Lab-Frames

Talboys offers the widest choice of standard lab frames available, plus the accessories to custom-fit any laboratory with the right frame for the job. Standard Lab-Frame sets are available in five sizes. Options of traditional center-less ground aluminum, non-corroding fiberglass, or tough stainless steel rods are available. Nickel-plated zinc connectors and lab-frame feet are standard with all kits.

### Small Lab-Frame

Vertical mounting, great for glassware set-ups in small laboratories or where space is limited. Frame measures 24 x 24" (610 x 610mm). Base is 18" (457mm) wide for stability. Base may be permanently mounted to bench top with screws (included).

Components:

- (8) 2" (51mm) rods
- (2) 18" (457mm) rods
- (8) 24" (610mm) rods
- (18) S-Connectors
- (4) Rod End Connectors
- (4) Lab-Frame Feet



Frame Dimensions	Base Dimensions	Aluminum Part Number	Fiberglass Part Number	Stainless Steel Part Number
24 x 24" (610 x 610mm)	18" (457mm) wide	916173	916193	916197

### Medium Lab-Frame

Horizontal or vertical mounting, convenient for distillation or general set-up. Frame measures 24 x 48" (610 x 1219mm). Base is 18" (457mm) wide for stability.

Components:

- (8) 2" (51mm) rods
- (2) 18" (457mm) rods
- (7) 24" (610mm) rods
- (4) 48" (1219mm) rods
- (35) S-Connectors
- (4) Rod End Connectors
- (4) Lab-Frame Feet



Frame Dimensions	Base Dimensions	Aluminum Part Number	Fiberglass Part Number	Stainless Steel Part Number
24 x 48" (610 x 1219mm)	18" (457mm) wide	916174	916194	916198

## Lab-Frames

**Large Lab-Frame**

This 48 x 48" (1219 x 1219mm) frame is ideal for complex glassware set-ups. Base is 18" (457mm) wide for stability.

Components:

- (10) 2" (51mm) rods
- (3) 18" (457mm) rods
- (2) 36" (914mm) rods
- (10) 48" (1219mm) rods
- (38) S-Connectors
- (4) Rod End Connectors
- (6) Lab-Frame Feet

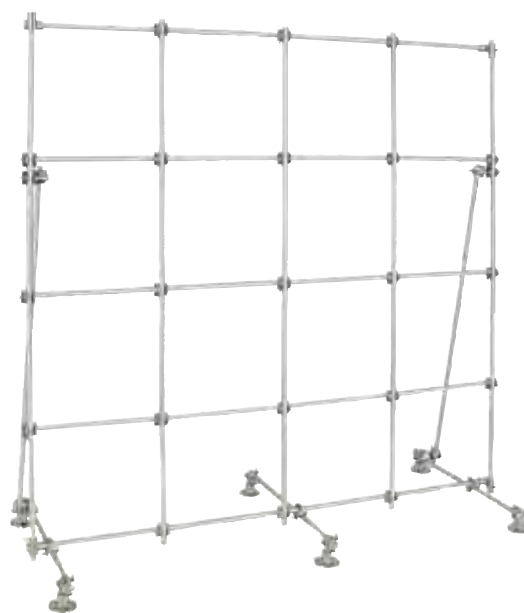

Frame Dimensions	Base Dimensions	Aluminum Part Number	Fiberglass Part Number	Stainless Steel Part Number
48 x 48" (1219 x 1219mm)	18" (457mm) wide	916175	916195	916199

**Extra-Large Lab-Frame**

Versatile, adaptable Extra-Large Lab-Frame measures 48 x 72" (1219 x 1829mm) and may be used either horizontally or vertically.

Components:

- (6) 2" (51mm) rods
- (6) 12" (305mm) rods
- (2) 24" (610mm) rods
- (7) 48" (1219mm) rods
- (5) 72" (1829mm) rods
- (45) S-Connectors
- (4) Rod End Connectors
- (8) Lab-Frame Feet



Frame Dimensions	Aluminum Part Number	Fiberglass Part Number	Stainless Steel Part Number
48 x 72" (1219 x 1829mm)	916176	916196	916200

### Heavy-Duty Lab-Frame

Floor mounted, free-standing unit is specifically designed for heavy-duty work such as pilot plant set-ups. Outside frame is constructed of a strong, but lightweight steel channel. Interior lattice uses a horizontal channel connector; one end accommodates the rod, the other end fits into the channel and locks tightly with a bolt. Loosen the bolt, and the connector slides easily along the channel track for simple lattice adjustment. Entire apparatus is supported on sturdy, counter-weighted cast iron feet, which may be bolted to the floor for added stability required in top-heavy installations.

Components:

- (5) 48" (1219mm) rods
- (3) 72" (1829mm) rods
- (15) S-Connectors
- (16) Channel Connectors
- (24) Clamping Nuts
- (2) 21.7" (551mm) Cast Iron Feet
- (1) Frame Kit
- (1) Wrench



Frame Dimensions	Overall Dimensions	Aluminum Part Number	Fiberglass Part Number	Stainless Steel Part Number
48 x 72" (1219 x 1829mm)	75 x 72" (1905 x 1829mm)	916178	916201	916202

### Fume Hood Kits

Choose from four kits specifically designed to fit within laboratory fume hoods. All components are constructed of stainless steel with the exception of the Frame Connectors which are made of aluminum with a silicon finish.

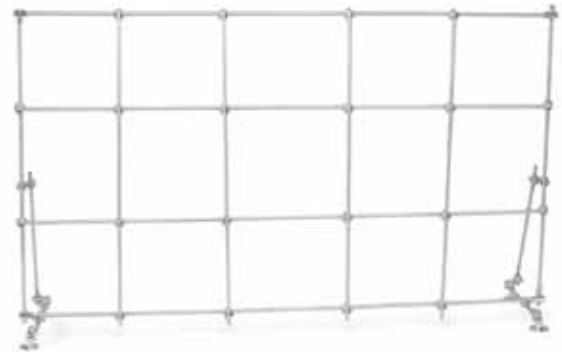

#### 4' (1.22m) Fume Hood Kit

Components:

- (8) 2" (51mm) rods
- (2) 12" (305mm) rods
- (2) 18" (457mm) rods
- (4) 36" (914mm) rods
- (4) 38" (965mm) rods
- (30) Frame Connectors
- (4) Rod End Connectors
- (4) Lab-Frame Feet

Frame: 36 x 38" (914 x 965mm)

Base: 12" (305mm) wide

#### 5' (1.52m) Fume Hood Kit

Components:

- (8) 2" (51mm) rods
- (2) 12" (305mm) rods
- (2) 18" (457mm) rods
- (5) 36" (914mm) rods
- (4) 50" (1270mm) rods
- (34) Frame Connectors
- (4) Rod End Connectors
- (4) Lab-Frame Feet

Frame: 36 x 50" (914 x 1270mm)

Base: 12" (305mm) wide

#### 6' (1.83m) Fume Hood Kit

Components:

- (8) 2" (51mm) rods
- (2) 12" (305mm) rods
- (2) 18" (457mm) rods
- (6) 36" (914mm) rods
- (4) 62" (1575mm) rods
- (38) Frame Connectors
- (4) Rod End Connectors
- (4) Lab-Frame Feet

Frame: 36 x 62" (914 x 1575mm)

Base: 12" (305mm) wide

#### 8' (2.44m) Fume Hood Kit

Components:

- (10) 2" (51mm) rods
- (3) 12" (305mm) rods
- (2) 18" (457mm) rods
- (8) 36" (914mm) rods
- (4) 86" (2184mm) rods
- (45) Frame Connectors
- (4) Rod End Connectors
- (6) Lab-Frame Feet

Frame: 36 x 86" (914 x 2184mm)

Base: 12" (305mm) wide

Part Number	Part Number	Part Number	Part Number
916244	916245	916246	916248

## Support Stands

## Support Stands

Support Stands are made entirely of 303 stainless steel. They have a durable base that can accommodate vessels up to 18" (457mm) in diameter within the "U". The base area is 17.75" (451mm) across x 10.5" (267mm) deep overall. The stainless steel support rod is 0.63" (16mm) in diameter and is screwed to the support base. Two additional threaded holes in the base legs accommodate rods, enabling the stand to support two mixers. The "U" shape of the base should be turned from the mixing apparatus when the two outside rods are in use. This balances the weight, preventing the base from tipping.

Description	Part Number
Support Stand with 23" (584mm) Rod	110-23
Support Stand with 28" (711mm) Rod	110
Support Stand with 36" (914mm) Rod	110-36
Support Stand with 40" (1016mm) Rod	110-40
Support Stand with 48" (1219mm) Rod	110-48
Support Stand with 60" (1524mm) Rod	110-60

## Support Stand Stabilizer Knobs

Support Stand Stabilizer Knobs can be added to the two additional threaded holes in the base legs to secure the stand to a bench top.

Description	Part Number
Support Stand Stabilizer Knobs (2 per pack)	110C

## Heavy-Duty Support Stands

Heavy-Duty Support Stands have a four point cast iron base with stainless steel support rod. They are designed to accommodate vessels up to 12" (30.5cm) in diameter to sit close to the support rod. They have rubber cushions on each of the four corners. The base area is 16.5" (41.9cm) across x 12" (30.5cm) deep overall. They are ideal for Heavy-Duty Mixers, page 116-117.

Description	Part Number
Heavy-Duty Support Stand with 18" (457mm) Rod	916204
Heavy-Duty Support Stand with 23" (584mm) Rod	916232
Heavy-Duty Support Stand with 28" (711mm) Rod	916233
Heavy-Duty Support Stand with 36" (914mm) Rod	916234
Heavy-Duty Support Stand with 40" (1016mm) Rod	916235
Heavy-Duty Support Stand with 48" (1219mm) Rod	916236
Heavy-Duty Support Stand with 60" (1524mm) Rod	916237

## Replacement Support Rods

Description	Diameter	Part Number
18" (457mm) Stainless Steel Rod	0.63" (16mm)	110A-18
23" (584mm) Stainless Steel Rod	0.63" (16mm)	110A-23
28" (711mm) Stainless Steel Rod	0.63" (16mm)	110A
36" (914mm) Stainless Steel Rod	0.63" (16mm)	110A-36
40" (1016mm) Stainless Steel Rod	0.63" (16mm)	110A-40
48" (1219mm) Stainless Steel Rod	0.63" (16mm)	110A-48
60" (1524mm) Stainless Steel Rod	0.63" (16mm)	110A-60



Support Stand



Support Stand Stabilizer Knobs



Heavy-Duty Support Stand

## Support Stands

### Cast Iron Support Stands

Cast iron support stand bases are constructed with black enamel finish for chemical resistance and durability. All bases feature a built-in support rod holder with locking knob that accepts a 0.51" (13mm) diameter support rod. U-shaped base features three built-in support rod holders and accommodates vessels up to 5" (127mm) in diameter.

**NOTE:** Support rods are not included.

### Rectangular Base Support Stand, Cast Iron

Description	Dimensions	Part Number
Rectangular Base (only)	4 x 6" (102 x 152mm)	916380
Rectangular Base (only)	5 x 8" (127 x 203mm)	916381
Rectangular Base (only)	6 x 9" (152 x 229mm)	916382
Rectangular Base (only)	8 x 10" (203 x 254mm)	916383



916383

### Tripod Base Support Stand, Cast Iron

Description	Overall Footprint Diameter	Part Number
Tripod Base (only)	14.75" (375mm)	916384



916384

### U-Shaped Base Support Stand, Cast Iron

Description	Dimensions	Part Number
U-Shaped Base (only)	7 x 7" (178 x 178mm)	916385



916385

### Aluminum Support Rods

Description	Diameter	Part Number
12" (305mm) Aluminum Rod	0.51" (13mm)	916143
18" (457mm) Aluminum Rod	0.51" (13mm)	916144
24" (610mm) Aluminum Rod	0.51" (13mm)	916145
36" (914mm) Aluminum Rod	0.51" (13mm)	916146

### Stainless Steel Support Rods

Description	Diameter	Part Number
12" (305mm) Stainless Steel Rod	0.51" (13mm)	916165
18" (457mm) Stainless Steel Rod	0.51" (13mm)	916166
24" (610mm) Stainless Steel Rod	0.51" (13mm)	916167
36" (914mm) Stainless Steel Rod	0.51" (13mm)	916168



## Support Plates

**Round Support Plate**

Aluminum plate supports beakers, mantles and petri dishes. Fits standard lab-frames using Talboys connectors or holders, shown on pages 138-140.

Description	Distance from Rod	Part Number
6" (152mm)	2.6" (66mm)	916206



916206

**Support Plates**

Designed to hold hotplates, stirrers, hotplate-stirrers, and other apparatus to lab-frames or ring stands. Aluminum construction offers strength and durability. Support plates include a non-skid rubber mat and a built-in holder that grips rods up to 0.75" (19mm) in diameter.

Size	Plate Dimensions	Distance from Rod	Part Number
Small	9.5 x 6.5" (241 x 165mm)	1.9" (48mm)	916299
Medium	12.75 x 9" (324 x 229mm)	1.9" (48mm)	916300
Large	15.75 x 12" (400 x 305mm)	1.9" (48mm)	916302



916300

## Lab-Lifts

### Talboys Aluminum Lab-Lifts

- Exceptional stability and durability
- Aluminum construction
- Three convenient sizes

Aluminum Lab-Lifts provide stable height adjustment for various items in the lab such as flasks, baths, and small equipment. Top and bottom decks are constructed of anodized aluminum. Internal supports and drive screws are constructed of stainless steel. Oversized sure-grip adjustment knobs provide smooth and accurate height adjustment. Lab-Lifts accept optional Support Rod Kit which mounts to the upper deck.

Deck Size	Min. to Max. Height	Max. Load*	Part Number
4 x 4" (102 x 102mm)	2.5 to 5" (64 to 127mm)	66lbs (29.94kg)	960080
6 x 6" (152 x 152mm)	3 to 9.75" (76 to 248mm)	132lbs (59.87kg)	960081
8 x 8" (203 x 203mm)	3 to 9.75" (76 to 248mm)	176lbs (79.83kg)	960082
10 x 10" (254 x 254mm)	3.5 to 13" (89 to 330mm)	186lbs (84.37kg)	960083

**NOTE:** Maximum load rating represents static weight only. Static weight is the amount a unit can hold, not lift.



### OPTIONAL ACCESSORY

#### 17" Support Rod Kit

Ideal for creating an adjustable support stand for mounting various items such as thermometer clamps, temperature probes, flask and column clamps. This kit allows you to mount a 17" (432mm) threaded vertical support rod to the upper deck of a 6 x 6", 8 x 8", or 10 x 10 Lab-Lift by screwing the rod into the pre-drilled hole.

#### 17" SUPPORT ROD KIT INCLUDES:

- 1 - 17" (432mm) Stainless Steel Rod
- 1 - Jam Nut
- 1 - Flat Washer

Description	Rod Diameter	Part Number
17" Support Rod Kit	0.51" (13mm)	960030



## Lab-Lifts

**Talboys Heavy-Duty Lab-Lifts**

- Stainless steel construction
- Seven convenient sizes to choose from
- Autoclavable and chemical resistant

These Heavy-Duty, Stainless Steel Lab-Lifts are ultra-stable lifting platforms with exceptional strength and durability. Constructed of stainless steel, Lab-Lifts are designed for use in extreme environments and high load applications. Equipped with oversized, sure-grip adjustment knobs that provide extra leverage for easy height adjustments. Durable construction allows lifts to be autoclaved or chemically cleaned. Ideal for use in fume hoods or bench tops and holds a variety of items such as glassware, hotplates, baths, and magnetic stirrers.

Deck Size	Min. to Max. Height	Max. Load*	Part Number
3 x 3" (76 x 76mm)	2.5 to 5" (64 to 127mm)	100lbs (45.36kg)	960054
4 x 4" (102 x 102mm)	2.5 to 5" (64 to 127mm)	100lbs (45.36kg)	960055
6 x 6" (152 x 152mm)	3 to 9.75" (76 to 248mm)	133lbs (60.33kg)	960056
8 x 8" (203 x 203mm)	3 to 9.75" (76 to 248mm)	227lbs (102.97kg)	960057
10 x 10" (254 x 254mm)	3.5 to 13" (89 to 330mm)	247lbs (112.04kg)	960058
12 x 12" (305 x 305mm)	4 to 19.5" (102 to 495mm)	100lbs (45.36kg)	960059
16 x 16" (406 x 406mm)	4 to 19.5" (102 to 495mm)	100lbs (45.36kg)	960060

**NOTE:** Maximum load rating represents static weight only. Static weight is the amount a unit can hold, not lift.

**OPTIONAL ACCESSORIES****17" Support Rod Kit**

Ideal for creating an adjustable support stand for mounting various items such as thermometer clamps, temperature probes, flask and column clamps. This kit allows you to mount a 17" (432mm) threaded vertical support rod to the upper deck of a 6 x 6", 8 x 8", 10 x 10", 12 x 12" or 16 x 16" Lab-Lift by screwing the rod into the pre-drilled hole.

**17" SUPPORT ROD KIT INCLUDES:**

- 1 - 17" (432mm) Stainless Steel Rod
- 1 - Jam Nut
- 1 - Flat Washer

Description	Rod Diameter	Part Number
17" Support Rod Kit	0.51" (13mm)	960030

**Ratchet Tool**

Designed to add extra leverage to your 12 x 12" or 16 x 16" Lab-Lift. This recommended Ratchet Tool easily attaches to the actuating rod to allow easy, accurate adjustments.

Description	Part Number
Ratchet Tool	960061

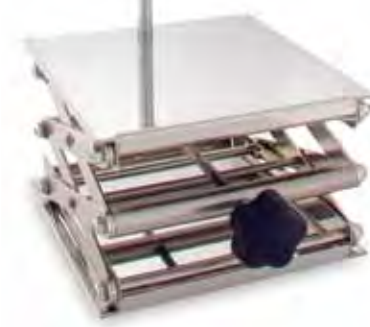
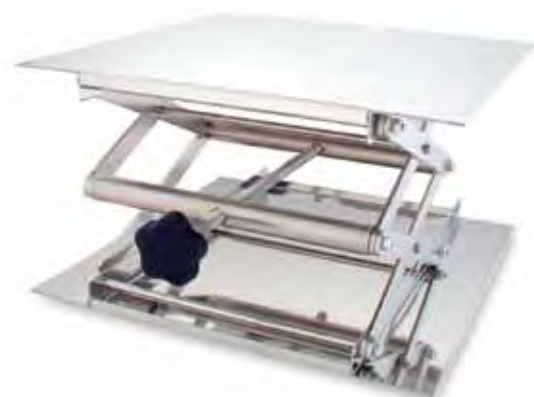

### Cylinder Bench Clamps

Rugged cast aluminum clamps safely secure gas cylinders to benches, tables or other flat surfaces up to 2.5" (64mm) thick. The 1" (25mm) wide, 54" (1372mm) long nylon strap features a nickel-plated, non-slip spring catch and buckle for easy adjustment around cylinders from 4 to 14" (102 to 356mm) in diameter. Models 711 and 716 available with or without a "Secure Cylinder" safety message strap.

#### Model 711 Bench Clamp

This bench clamp has a large tightening handle for mounting to any flat surface up to 2.5" (64mm) thick. A nylon pad prevents damage to the bench or table surface. Two tapered mounting screw holes are provided for permanent attachment to bench-top.



safety message strap



Description	Dimensions L x W x H (closed)	Cylinder Diameter	Part Number
Model 711 Bench Clamp with Strap	3.25 x 5.25 x 6.5" (83 x 133 x 165mm)	4 to 14" (102 to 356mm)	970036
Model 711 Bench Clamp with Safety Message Strap	3.25 x 5.25 x 6.5" (83 x 133 x 165mm)	4 to 14" (102 to 356mm)	973036

#### Model 716 Bench Clamp

This bench clamp is similar to Model 711, but includes a sturdy safety chain for extra security. Chain measures 49" (1245mm).



safety message strap



Description	Dimensions L x W x H (closed)	Cylinder Diameter	Part Number
Model 716 Bench Clamp with Strap & Chain	3.25 x 5.25 x 6.5" (83 x 133 x 165mm)	4 to 14" (102 to 356mm)	972036
Model 716 Bench Clamp with Safety Message Strap & Chain	3.25 x 5.25 x 6.5" (83 x 133 x 165mm)	4 to 14" (102 to 356mm)	974036

#### Model 712 Heavy-Duty Bench Clamp

This bench clamp has two screw clamps to tighten for extra firm mounting to any flat surface up to 1.75" (45mm) thick with a 1.25" (32mm) overhang. Especially convenient for temporary storage situations. Rugged cast aluminum bench clamp features a 1" (25mm) wide, 54" (1372mm) long nylon strap with nickel-plated, non-slip spring catch buckle to hold cylinders from 4 to 14" (102 to 356mm) in diameter. This clamp is not available with a safety message strap.



Description	Dimensions L x W x H (closed)	Cylinder Diameter	Part Number
Model 712 Heavy-Duty Bench Clamp with Strap	3.25 x 6 x 4.5" (83 x 152 x 114mm)	4 to 14" (102 to 356mm)	970035

## Gas Cylinder Safety Supports

**Model 715 Wall Bracket**

Cylinder wall-mount brackets are constructed of cast aluminum and contoured to allow cylinders to fit firmly along the support edge. Recessed screw holes at each side of the bracket allow for easy wall mounting. Features a 1" (25mm) wide, 54" (1372mm) long nylon strap with nickel-plated, non-slip spring catch and buckle for fast, easy adjustment. Available with or without a "Secure Cylinder" safety message strap. For cylinders from 4 to 14" (102 to 356mm) in diameter.



safety message strap



Description	Dimensions L x W x H	Cylinder Diameter	Part Number
Model 715 Wall Bracket with Strap	1.88 x 8.13 x 4.63" (48 x 206 x 118mm)	4 to 14" (102 to 356mm)	970037
Model 715 Wall Bracket with Safety Message Strap	1.88 x 8.13 x 4.63" (48 x 206 x 118mm)	4 to 14" (102 to 356mm)	973037

**Model 717 Wall Bracket**

This wall bracket is similar to Model 715, but includes a sturdy safety chain for extra security. Chain measures 49" (1245mm).



safety message strap



Description	Dimensions L x W x H	Cylinder Diameter	Part Number
Model 717 Wall Bracket with Strap & Chain	1.88 x 8.13 x 4.63" (48 x 206 x 118mm)	4 to 14" (102 to 356mm)	972047
Model 717 Wall Bracket with Safety Message Strap & Chain	1.88 x 8.13 x 4.63" (48 x 206 x 118mm)	4 to 14" (102 to 356mm)	974037

### Model 701 PVC Coated Stand

The PVC coated stand has a flat bottom support so it can't "ride up" on the cylinder. Includes an adjustable 1" (25mm) wide, 54" (1372mm) long nylon strap with nickel-plated, non-slip spring catch and buckle for fast, easy adjustment to keep the cylinder safely in place against upper support bar. Lower support bar stops cylinder shift. The PVC coating prevents marring of the cylinder surface. This clamp is not available with a safety message strap.



Description	Dimensions L x W x H	Cylinder Diameter	Part Number
Model 701 PVC Coated Stand	17.25 x 17.25 x 10.75" (438 x 438 x 273mm)	7 to 10" (178 x 254mm)	970045

### Model 703 Stand

This cast aluminum stand hinges open and has 4 thumbscrews to tightly grip cylinders from 8 to 9" (203 to 229mm) in diameter.



Description	Dimensions (Dia. x H)	Cylinder Diameter	Part Number
Model 703 Stand	18.25 x 6" (464 x 152mm)	8 to 9" (203 x 229mm)	970040

### Model 704 Adjustable Stand

Heavy-duty, cast aluminum stand with adjustable "L" brackets hold cylinders from 6 to 9.25" (152 to 235mm) in diameter. Hinges open for installation without lifting the cylinder or disturbing connections. Prevents accidental tipping. Hinges open for easy, no-lifting installation.



Description	Dimensions (Dia. x H)	Cylinder Diameter	Part Number
Model 704 Adjustable Stand	18.5 x 7.5" (470 x 191mm)	6 to 9.25" (152 x 235mm)	970039

### Model 713 Portable Stand

This cast iron portable cylinder stand offers a sturdy cylinder stand and a convenient cylinder dolly all-in-one. This cylinder stand is designed in two interlocking halves and can be installed without lifting the tank. Built-in rubber wheels for easy mobility. Three thumbscrews tightly grip cylinder.



Description	Dimensions (Dia. x H)	Cylinder Diameter	Part Number
Model 713 Portable Stand	15.5 x 3" (394 x 76mm)	7 to 9.25" (178 x 235mm)	970041

## Flow Control

Talboys flow control devices offer selection and quality. They are finely machined to deliver accurate regulation or interruption of fluid flow. Every flow control device resists corrosion and rust. Hosecocks offer easy one-hand operation. Convex bearing surfaces and rounded edges protect tubing. Pinchcocks are designed to quickly start and stop flow and provide complete closure without damaging tubing. Operated with a simple squeeze. Nickel-plated construction (unless otherwise noted).

**Regular Hosecock**

Adjustment screw with oversized head for accurate regulation. Built-in side lugs for foot mounting. Tubing retainer screw.

**STAINLESS STEEL**

Min. to Max. Grip	Dimensions (W x H - open)	Part Number
0 to 17mm (0 to 0.67")	37 x 62mm (1.46 x 2.44")	916361

**NICKEL-PLATED ZINC**

Min. to Max. Grip	Dimensions (W x H - open)	Part Number
0 to 17mm (0 to 0.67")	37 x 62mm (1.46 x 2.44")	916062

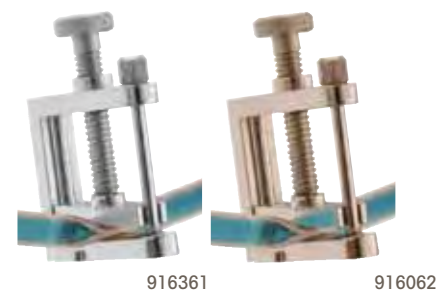
**Heavy-Duty Hosecock**

Large hand wheel for ease of flow adjustment. Unique design offers unparalleled control. Works well with heavy cut nylon braided tubing.

Min. to Max. Grip	Dimensions (W x H - open)	Part Number
0 to 29mm (0 to 1.14")	57 x 106mm (2.24 x 4.17")	916184

**Hosecock Extension Clamp**

Similar to regular hosecock but with 145mm (5.7") bottom mounted extension rod for attachment to frames and rods.

Min. to Max. Grip	Arm Length	Arm Dia.	Overall Length	Part Number
0 to 17mm (0 to 0.67")	145mm (5.71")	8mm (0.32")	175mm (6.89")	916064

**Hosecock Foot**

Add this option to Regular Hosecock (916062 or 916361) for bench or table mounting. Includes two mounting screws.

Diameter	Part Number
27mm (1.06")	916063

**Regular Pinchcock**

For routine stop/start flow operation.

Min. to Max. Grip	Clamp Height	Part Number
0 to 12mm (0 to 0.47")	47mm (1.85")	916082

**Variable Flow Pinchcock**

For precise flow adjustment and duplication of flow rates.

Min. to Max. Grip	Clamp Height	Part Number
0 to 13mm (0 to 0.51")	47mm (1.85")	916084

**Heavy-Duty Pinchcock**

Equipped with heavy-duty spring for tough jobs. Ensures complete closure.

Min. to Max. Grip	Clamp Height	Part Number
0 to 11mm (0 to 0.43")	48mm (1.89")	916083









1609

## Hengar Boiling Granules

### For Prevention of "Bumping" in Boiling Liquids

In any laboratory procedure involving the boiling of a liquid, inert and insoluble Hengar Granules effectively prevent superheating with its attendant dangerous explosive vaporization commonly known as "bumping".

A few Hengar Granules in any boiling liquid permit a steady copious stream of bubbles to escape without this spasmodic splatter. Evaporation or distillation proceeds quietly and smoothly. Sharper fractions result. Flask breakage is reduced and watching time is minimized. Froth is spread out evenly and does not climb the neck of the flask. Especially useful in boiling soap solutions and evaporating ethereal extracts of fat. With Hengar Granules in the vessel, any gases formed are extracted from the liquid quickly and completely.

Insoluble, Hengar Granules cannot contaminate the liquid. They remain at the bottom of the flask or beaker, permitting the liquid to be readily poured off. After use, the granules are simply discarded. Hengar Granules are also available with a pure selenium coating, for use in the Kjeldahl digestion and distillation method of organic nitrogen determination.



### Hengar Granules, Plain

High purity, white, amphoteric alundum granule. Extremely hard porous surface. Will not crumble or "powder". Four mesh granule size. Specific gravity 3.97.

Description	Quantity Per Package	Part Number
136A Plain Granules	100g	901600
136B Plain Granules	250g	901700
136C Plain Granules	500g	901800
136D Plain Granules	10kg	901900

### Hengar Granules, Plain Micro

High purity, white, amphoteric alundum granule. Extremely hard porous surface. Will not crumble or "powder". Ten mesh granule size. Specific gravity 3.97.

Description	Quantity Per Package	Part Number
136AA Plain Micro Granules	100g	903700
136CC Plain Micro Granules	500g	903800

### Hengar Selenized Granules

High purity, amphoteric alundum, specially treated with selenium for use in determination of amino and cyanide nitrogen. Four mesh granule size, iridescent bluish black color. Selenium as a solid is relatively nontoxic. Its vapor or fumes are highly toxic. TLV 0.2 mg/cubic meter. Specific gravity 4.10.

Description	Quantity Per Package	Part Number
132A Selenized Granules	100g	901100
132B Selenized Granules	250g	901200
132C Selenized Granules	500g	901300

### Hengar Selenized Granules, Micro

High purity, amphoteric alundum, specially treated with selenium for use in determination of amino and cyanide nitrogen. Ten mesh granule size, iridescent bluish black color. Specific gravity 4.10.

Description	Quantity Per Package	Part Number
132AA Selenized Micro Granules	100g	901400
132CC Selenized Micro Granules	500g	901500

### Hengar Carborundum #12 Granules

Hard, bluish black, iridescent silicon carbide granule. No reduction characteristics. Oxidizes slowly at 1472°F (800°C). Twelve mesh granule size. Specific gravity 3.20.

Description	Quantity Per Package	Part Number
133A Carborundum #12 Granules	100g	902000
133B Carborundum #12 Granules	500g	902100

### Aitch-Tu-Ess (H<sub>2</sub>S)

An economical way to produce hydrogen sulfide gas for use in qualitative analysis and the general chemistry laboratory. Aitch-Tu-Ess is a dry mixture of sulfur, a highly condensed hydrocarbon, and an inert dispersal agent. The sulfur and the hydrocarbon are combined in the proportion most conducive to maximum yield of H<sub>2</sub>S gas, while the inert dispersal agent serves to support the reactants. This material, when heated, produces H<sub>2</sub>S gas which is highly toxic. Heating and all experiments should be conducted under a fume hood. The threshold limit value of H<sub>2</sub>S is 10 parts per million or 15 milligrams per cubic meter.

Description	Quantity Per Package	Part Number
310A Aitch-Tu-Ess	1 Kilo Box	903400
330A Aitch-Tu-Ess	1-Doz. 5g Cartridges (1 Dozen/Box)	903500
330B Aitch-Tu-Ess	1-Gross 5g Cartridges (1 Dozen/Box)	903600

Microplate Stability Chamber

The Microplate Stability Chamber is a tool proven to reduce the variation often experienced in cell-based assays. This chamber is inserted into standard or CO<sub>2</sub> incubators. Traditional incubators often create heterogeneous environments for cell growth and biochemical assays due to frequent door openings and "hot spots" within the incubator. This chamber uses the incubator heat and atmosphere to create a homogeneous micro-environment for microwell plates. High humidity within the chamber eliminates evaporation from the plates that causes the edge effect. The thick aluminum shelf distributes heat evenly to the plates thus creating excellent temperature uniformity. Variation in cell-based assays has been reduced by as much as 50% using the Microplate Stability Chamber. The chamber includes a fan driven by the appropriate power adapter.

**Overall dimensions (L x W x H):** 16 x 14 x 3.1" (40.6 x 35.6 x 7.9cm)

**Tray Dimensions (L x W x H):** 13.75 x 11.2 x 0.75" (34.9 x 28.4 x 1.9cm)



Microplate Stability Tray

The shelf used in the Microplate Stability Chamber can improve temperature uniformity of microwell plates in incubators. The anodized aluminum shelf holds six plates. One included with unit.

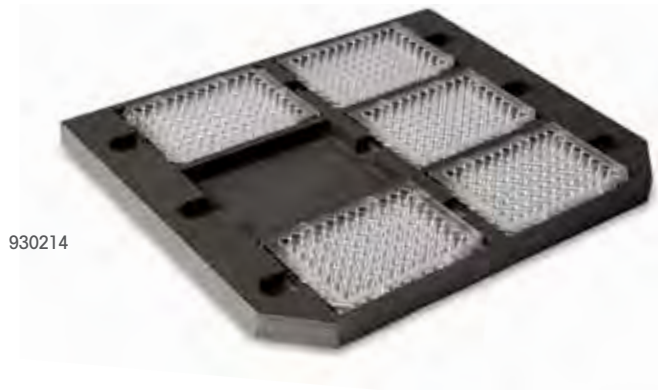

930214



Description	Part Number
Microplate Stability Chamber, 120V (50/60 Hz)	930212
Microplate Stability Chamber, 230V (50/60 Hz)	930213
Replacement	Part Number
Microplate Tray	930214





173

## Other Quality Talboys Products

### Inoculating Turntables

Talboys hand-operated inoculating turntables produce almost concentric circles of bacterial colonies that are evenly distributed across petri dishes. Cast iron turntables are coated with gray baked acrylic enamel.

The 76mm (3") high, small turntable accommodates 100mm petri dishes. It has a tripod base to bring work approximately to eye level. It has a center disk covered with non-skid rubber lining.

The large turntable accommodates 100mm or 150mm petri dishes. It has a height of only 32mm (1.26"), ideal for steadying a forearm on the work surface while plating. The large turntable contains two circular sections. The top section has a raised gripper lip as well as a recessed center disk covered with non-skid rubber lining.



982007



982006

Description	Dimensions (Dia. x H)	Part Number
Small Turntable	4.49 x 3.03" (114 x 77mm)	982007
Large Turntable	5.91 x 1.26" (150 x 32mm)	982006

### Slide Staining Rack

Constructed of stainless steel, the Talboys Slide Staining Rack will resist corrosion under normal use. Adjustable to fit trays or sinks up to 533mm (21") inside.



954002

Description	Dimensions (L x W)	Part Number
Slide Staining Rack	23.74 x 3.5" (603 x 89mm)	954002

### Airejector

Rapid air removal evacuates 1 liter of air to 711mm (28") of vacuum in 30 seconds. Works with compressed air sources to 60 psi. Nickel-plated construction.



982001

Description	Length	Part Number
Airejector	5.51" (140mm)	982001





201 Wolf Drive Thorofare, NJ 08086  
Phone: 856.686.1600 • Toll Free: 1.888.TALBOYS • Fax: 856.686.1601  
Web: [www.talboys.com](http://www.talboys.com) • Email: [info@talboys.com](mailto:info@talboys.com)  
520001-00 (Rev-3/16)