

Operating Manual (EN)

Translation of the original operating manual in German

4-head diaphragm vacuum pump

MPC 1203 E

MPC 903 Z

MPC 603 T

MPC 303 V

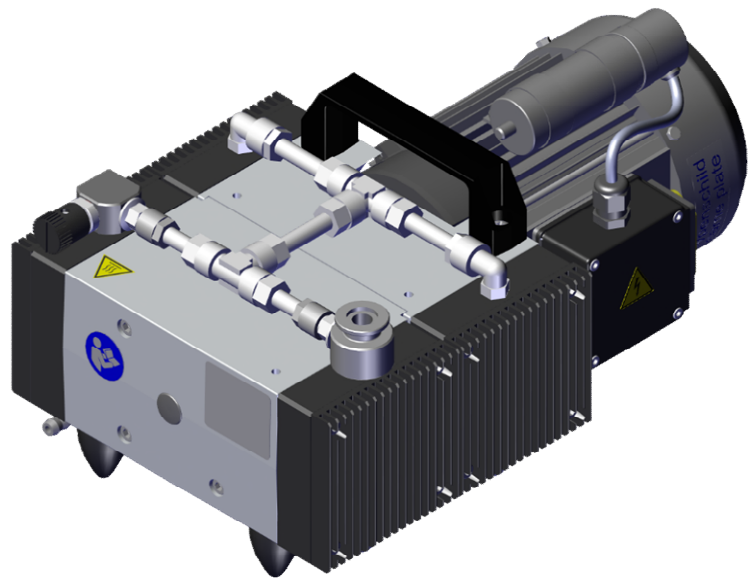

NOTE

- ▶ Read this operating manual carefully before use.
- ▶ Keep this operating manual for future reference.

Manufacturer

Gardner Denver Thomas GmbH
Am Vogelherd 20
98693 Ilmenau
Germany



+49 3677 604 0



+49 3677 604 131



welch.emea@irco.com



www.welchvacuum.com

Imprint

© 2024

No part of this publication may be reprinted or reproduced in any form or by any means without the prior written permission of Gardner Denver Thomas GmbH.

All rights under copyright law are reserved by Gardner Denver Thomas GmbH.

Subject to change without notice.

Content

1 Important Information.....5

1.1 Note for the operator / user5

1.2 Display.....6

1.2.1 Warning and safety symbols 6

1.2.2 Additional information..... 6

1.2.3 Indicator / Symbols..... 7

1.3 Abbreviations8

2 Security.....9

2.1 General information.....9

2.1.1 Appropriate use..... 9

2.1.2 Use contrary to the intended purpose..... 9

2.1.3 Foreseeable misuse 10

2.2 Target groups10

2.2.1 Qualification of personnel..... 10

2.2.2 Responsibilities 11

2.3 Safety precautions11

2.3.1 General safety precautions 11

2.3.2 Safe operation..... 11

2.4 Special hazards.....12

2.4.1 Hazardous substances..... 12

2.4.2 Electricity 13

2.4.3 Mechanics 13

2.4.4 Temperatures..... 13

2.4.5 Vacuum 14

2.4.6 ATEX applications 15

3 Technical data16

3.1 Dimensions.....16

3.2 Characteristic values16

3.3 General Connections17

3.4 Materials.....18

4 Description 19

4.1 General information.....19

4.2 Design19

4.2.1 Images of the device 20

4.2.2 Motor thermal protection 21

4.2.3 Gas Ballast 21

4.3 Accessories22

4.3.1 Accompanying material..... 22

4.3.2 Optional fittings 22

5 Setting up and connecting.....24

5.1 Storage.....24

5.2 Unpack.....24

Content

5.3	Set up	24
5.4	Assembly	24
5.5	Connect	25
5.5.1	Connecting pneumatics	25
5.5.2	Electrical connection.....	25
6	Operation	27
6.1	Commissioning	27
6.2	Safe operation	27
7	Operational faults.....	28
8	Maintenance.....	29
8.1	Maintenance and inspection.....	29
8.2	Maintaining by cleaning.....	29
8.3	Repairs carried out by the operator.....	30
8.3.1	Disassembly	31
8.3.2	Assembly	32
8.3.3	Functional test	32
8.4	Repairs carried out by the manufacturer	32
8.5	Disposal	33
9	Spare parts.....	34
9.1	Spare parts overview.....	34
9.2	Contact details for Support or to place an order	34
10	Annex:	35
10.1	EU Declaration of Conformity.....	35
10.2	Notes	36

1 Important Information

1.1 Note for the operator / user

Safety

- The user / personnel must have read and understood the operating manual completely before commencing work.
- The operating manual must be kept at the place of use at all times and be available to the user/personnel.
- It is not permitted to pass on the product without the operating manual.
- Safe operation can only be guaranteed by proper and sound use of the product. Safety instructions must be observed!

General information

- Vacuum device/vacuum system generally describes a combination of components for vacuum applications, such as a rotary evaporator with vacuum control device and a vacuum pump.
- The operator is responsible for the proper usage of vacuum apparatus / vacuum systems.

About the device

- The illustrations in the operating manual are based on design models and may differ from the original device.
- If illustrations are not displayed otherwise, then the illustration is configuration-independent. Please refer to deviations in device models.
- Throughout the rest of this manual, the 4-head diaphragm vacuum pump is referred to as the "device".
- "Device" describes the entire product, consisting of the built-in vacuum pump, add-on components and various other parts.
- The operator is responsible for the proper usage of the device and the vacuum apparatus/systems.
- Generally, the pneumatic connections are named as follows:
 - the inlet refers to the "intake" and
 - the output refers to the "pressure side" for exhaust gas.

Operating instructions convention

Description	Sample display
References to chapters are displayed in italics	See chapter <i>1 Important Information</i>
Hyperlinks (e.g. websites, email, etc.)	www.welchvacuum.com

Important Information

1.2 Display

1.2.1 Warning and safety symbols

The warning symbols are depicted as follows:

 Signal word "HAZARD LEVEL"	
Indicator	<ul style="list-style-type: none"> ▲ Nature and source of the hazard. △ Consequences of non-compliance. □ Escaping or avoiding the hazard.

Hazard level (signal word) and meaning

 DANGER
Indicates a grave hazard that will result in hazardous injuries or have fatal consequences.

 WARNING
Indicates a potentially hazardous situation, which, if not prevented, can lead to serious injuries or life-threatening consequences.

 CAUTION
Indicates a potentially hazardous situation. If not prevented, it could lead to minor injuries.

Safety Instructions

Additional symbol	SIGNAL WORD
	<ul style="list-style-type: none"> ▶ Important instructions for the user / operator. ⊘ Actions / activities that are <u>not</u> allowed.

Prohibition notices

	ATTENTION
	⊘ Description of prohibited actions.













1.2.2 Additional information

	Signal word
	➤ Information for the user / operator.

 Supplementary information for the user / operator.

1.2.3 Indicator / Symbols

Safety Indicator

Icons	Explanation	Icons	Explanation
	General warning sign		General mandatory sign
	Warning of electrical voltage		Observe operating manual
	Hot surface warning		Pull out the mains plug
	Toxic substances warning		Use gloves
	Warning of unexpected startup		Use eye protection
	Low temperature warning		General prohibition sign
	Explosive atmosphere warning		

Additional symbols

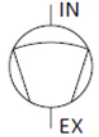
Icons	Explanation	Icons	Explanation
	General information		Diaphragm vacuum pump/pump head

Important Information

1.3 Abbreviations

Legend

Abbreviation	Name or meaning	Classification
A	"Ampere" current	Unit (electrical)
Fig.	Image	Name
abs.	absolute	Parameter (pressure)
AC 1~ 3~	Alternating current Single-phase Three-phase	Parameters (electrical)
OD	Outer diameter	Parameter (dimension)
DC	Direct current	Parameter (electrical)
DN	Nominal size, inner diameter (French diamètre nominal)	Parameter (dimension)
EPDM	Ethylene propylene diene rubber	Material
EX	Exhaust connection, pressure side	Designation (device)
hh:mm:ss	Hour/minute/second	Unit (time)
hPa	Hectopascal (1 hPa* = 1 mbar = 0.75 Torr)	Unit (pressure)t
Hz	"Hertz" frequency	Unit (electric)
IN	Inlet connection, intake	Designation (device)
ID	Inner diameter	Parameter (dimension)
max.	Maximum	Parameter
mbar	Millibar (1 mbar = 1 hPa* = 0.75 Torr)	Unit (pressure)t
min.	Minimum	Parameters
mm	Millimetre	Unit (dimension)
MPC	Chemical resistant diaphragm vacuum pump	device model
pneum.	pneumatic	Name
PP	Polypropylene	Material
PTFE	Polytetrafluoroethylene	Material
PVDF	Polyvinylidene fluoride	Material
RH	Relative humidity in %	Parameters
Torr	"Torricelli" (1 Torr = 1.33 mbar = 1.33 hPa*)	Unit (pressure)
MSL	Height above sea level	Parameters
V	Voltage	Unit (electric)
VCpro	Vacuum controller	Device model
W	Watt	Unit (electric)

 *SI unit

2 Security

2.1 General information

- The following safety and warning instructions must be read and understood by all users of the device.
- All operations may be carried out by trained personnel only. They must be familiar with and follow the particular hazards and understand how to operate the device and understand the operating manual.
- The device may only be used when it is in a technically perfect condition.

2.1.1 Appropriate use



	NOTE
	<ul style="list-style-type: none"> ▶ The design of the device must correspond to the conditions of use. The operator is solely responsible for this. ▶ Any use deviating from the above will be considered improper!

- The device may only be operated under the following conditions mentioned in the:
 - According to the characteristic values in chapter 3 *Technical data*,
 - on the rating plates (see Fig. 4-1, Fig. 4-2, Fig. 4-3 and Fig. 4-4) and
 - in the technical specifications for each order.
- The device is intended exclusively for vacuum technology applications.
- Gaseous media only may be pumped.
- The device is intended for indoor use only.

The following shall also be deemed as intended:

- Observe this operating manual including the safety/warning instructions.
- Compliance with the operating manuals incl. the safety/warning instructions for connected devices.
- Define and ensure safety measures (see chapter 2.3 *Safety precautions*).
- Compliance with the operating manuals for connected devices.
- Use of approved spare parts and accessories from Gardner Denver Thomas GmbH.

2.1.2 Use contrary to the intended purpose

 CAUTION	
	<ul style="list-style-type: none"> ▲ Risk of injury due to improper use! △ Use for purposes other <u>than</u> those for which it is intended may result in personal injury. □ The operator must ensure operation is in accordance with 2.1.1 <i>Appropriate use!</i>



	NOTE
	<ul style="list-style-type: none"> ▶ The operator must prevent applications that are not in accordance with the intended use. Precautions must be taken to ensure operation is in accordance with the intended use!

Security

The following shall be considered as use contrary to the intended purpose:

- Applications that do not correspond to the intended use (see chapter 2.1.1 *Appropriate use*).
- Use outside the specifications stated:
 - the technical data,
 - on the type plate or
 - in the conditions set out in the delivery contract.
- Operation in an unsound technical condition.
- Outdoor operation.

2.1.3 Foreseeable misuse

	ATTENTION
	<p> Misapplications are generally PROHIBITED. They are also considered to be contrary to the intended use!</p>

The following is considered foreseeable misuse:

- Operating manual is not provided or read.
- Manipulation of the device, e.g. unauthorized additions or modifications.
- Leaving critical applications unattended.
- Operating the device with tools or other unauthorised objects.
- Conveying inadmissible or liquid media.
- Operation by untrained or non-expert personnel.
- Safety precautions are inadequate or non-existent.
- Failure to comply with the regulations applicable by law.
- Operation in explosive applications and atmospheres (see chapter 2.4.6 *ATEX applications*).

2.2 Target groups

	NOTE
	<ul style="list-style-type: none"> ▶ Use by untrained personnel may result in misuse. ▶ The operator must ensure that personnel is properly trained and that all the necessary safety precautions are observed!

2.2.1 Qualification of personnel

User	Field of activity
User	Laboratory personnel, e.g., chemists
Operator	Responsible representative (processes)
Specialist	Person with professional qualifications, e.g., mechanic, electrician, laboratory manager etc.
Manufacturer	Service and maintenance / servicing only by the manufacturer or authorized service providers

2.2.2 Responsibilities

Activity	User	Specialist	Manufacturer
Set up/Connection	X	X	x
Commissioning/Operation	X	X	x
Analysis of operational malfunctions	X	X	x
Troubleshooting	X ¹	X	x
External maintenance/inspection	X	X	x
Internal maintenance/inspection	X ¹	X	x
Repair operator	X ¹	x	-
Damage report	X	x	-
Decontamination	-	X ²	-
Disposal	-	X	x

¹ Implementation by specially trained users only.

² Implementation by qualified and authorised service providers only.

2.3 Safety precautions

2.3.1 General safety precautions

	NOTE
	<ul style="list-style-type: none"> ▶ For user safety, the operator must define and enforce the safety precautions. ▶ Failure to do so may endanger the health of the user.

All safety precautions must have the highest priority to ensure the life and health of persons. In the event of possible safety risks, these are to be assessed and precautions taken to avert hazard. Applications with a risk to life and limb are not permitted.

Applicable operating manuals by the operator as well as national regulations for accident prevention, safety and occupational health must be observed.

	PROTECTIVE CLOTHING
	<ul style="list-style-type: none"> ▶ Protective clothing must be worn for applications requiring PPE. ▶ The operator must specify the type and use of protective clothing.



2.3.2 Safe operation

The following is mandatory!

- Operation in accordance with the safety requirements in chapter 2.1 *General information*.
- Use according to chapter 6.2 *Safe operation*.
- Do not open the connected vacuum apparatus until it has been ventilated (see chapter 2.4.5 *Vacuum*).
- Beware of potential hazards due to substances being pumped (see chapter 2.4.1 *Hazardous substances*).
- Pneumatic connections must be in accordance with chapter 5.5.1 *Connecting pneumatics*.
- Check attachment for damage (see chapter 5.1 *Storage*).
- Exhaust pressure must be atmospheric.
- Operate the device according to the technical data (see chapter 3.2 *Characteristic values*).

Vapour pumping

In applications with vapors, condensation may form in the delivery area of the device. If the application requires it, a steam condenser must be connected upstream to protect the device. The use must be defined by the operator.

 	CONDENSATION FORMATION
	<ul style="list-style-type: none"> ▶ Condensation can greatly reduce the service life of the components, especially the diaphragms. ▶ For vapour applications, the gas ballast must be used (see chapter 4.2.3 Gas Ballast). ▶ The device must be at the operating temperature before the application is started. ▶ After use, the device must be run down so that residual vapors are removed from the device.

 If the device is at the proper operating temperature, less condensate is formed in the feed

	Flushing
	<ul style="list-style-type: none"> ➤ By completely opening the suction side, the device can be cleaned internally with max. volume flow and the residual vapours or condensate can be removed.



	NOTE
	<ul style="list-style-type: none"> ▶ Flushing may cause droplets to be ejected on the discharge side and enter the surroundings (see chapter 2.4.1 Hazardous substances)!

2.4 Special hazards

	EMERGENCY SHUTDOWN
	<ul style="list-style-type: none"> ▶ In hazardous situations, disconnect the device from the mains by pressing the main switch or pulling the mains plug (Fig. 5-1).

 If no voltage is applied, the motor stops, and any valves are closed.

2.4.1 Hazardous substances

 WARNING	
	<ul style="list-style-type: none"> ▲ Risk to health due to hazardous substances! △ Hazardous substances in the medium to be pumped can cause personal injury and damage to property. □ Safety and warning instructions for handling hazardous substances must be observed!

	HAZARDOUS SUBSTANCES
	<ul style="list-style-type: none"> ▶ For applications involving substances bearing a GHS label, precautions must be taken to protect human health and the environment. ▶ The operator must, in compliance with the applicable regulations, assess possible hazards in order to prevent personal injury, or damage to the environment and property. ▶ This is the responsibility of the operator.

	ATTENTION
	<p>⊘ Operation with media that belong to a biological risk group that can endanger human health, e.g., viruses or bacteria, is generally PROHIBITED.</p>

Beware of applications using hazardous substances!

- The requirements laid down in the safety data sheets of the manufacturers must be complied with for hazardous substances.
- Prevent toxic and environmentally harmful substances escaping from the pumping device.
- Check the tightness and strength of the connection lines and all other connected components.
- Hazardous substances should be eliminated according to the technical possibilities before entering the device.

	MATERIAL RESISTANCE
	<p>▶ For applications involving aggressive media, the user must assess the resistance of the wetted parts of the device (see chapter 3.4 <i>Materials</i>).</p>

2.4.2 Electricity

DANGER	
	<p>▲ Danger of death due to electric current.</p>
	<p>△ There is an immediate danger of death from electric shock if live parts are touched.</p>
	<p>⊘ It is generally prohibited to open the device.</p>

Observe the following instructions:

- It is prohibited to operate the device without the casing.
- If the device is defective, switch it off, disconnect the mains plug and switch off the power supply.
- The mains plug and the cable must be in perfect condition.
- The connection must comply with the legal requirements.

	NOTE
	<p>▶ The device is to be evaluated as portable equipment.</p>

2.4.3 Mechanics

	NOTE
	<p>▶ Improper use or manipulation of the device can cause material damage to the connected devices or the equipment!</p>
	<p>⊘ External mechanical stresses and vibrations must <u>not</u> be transmitted to the device.</p>
	<p>▶ The device may be connected with a flexible laboratory hose only (e.g., a metal hose).</p>

2.4.4 Temperatures

CAUTION

Security

	<p>▲ Hot surface: Do not touch, risk of injury!</p> <p>△ High temperatures at the motor housing and surrounding areas (Fig. 2-1) during operation. Can cause burns, do not touch.</p> <p>□ If operating the main switch (Fig. 5-1/1), avoid touching hot surfaces. The operator must ensure safe operation and take precautions to protect the user, where necessary (see chapter 2.3 <i>Safety precautions</i>).</p>
---	--

	<p>ATTENTION</p>
<p>⊘ It is PROHIBITED to exceed the permissible media temperature!</p>	

	<p>MEDIA/OPERATING TEMPERATURE</p>
<p>▶ Observe the values for permissible operation (see chapter 3.2 <i>Characteristic values</i>).</p> <p>▶ There must be sufficient ventilation around the device (see chapter 5.3 <i>Set up</i>).</p>	

- ① The device heats up due to the motor and the temperature of the medium, and the compression.
- ① The device is equipped with a thermal circuit breaker that switches off the device in the event of overheating (see chapter 4.2.2 *Motor thermal protection*)



Fig. 2-1 Hot zone on the device, warning label Top view (right)

2.4.5 Vacuum



<p>⚠ WARNING</p>	
	<p>▲ Hazard of injury due to explosion!</p> <p>△ The vacuum device can explode due to a rise in pressure after a sudden intake of air. The splinters can seriously injure the user.</p> <p>□ Check the pressure of the vacuum pump before disconnecting the pneumatic connections.</p>

- ① The vacuum device can be under vacuum even when it is switched off.

	GLASSWARE
	<ul style="list-style-type: none"> ▶ Glassware is particularly high risk. Make sure that glassware is shatter-proof and unbreakable! ▶ Glassware must be suitable for the intended application.

2.4.6 ATEX applications

	ATTENTION
	<ul style="list-style-type: none"> ⊘ Operation in an explosive application and surroundings is PROHIBITED!

 DANGER	
	<ul style="list-style-type: none"> ▲ Hazard of explosion due to critical applications!
	<ul style="list-style-type: none"> △ There is a danger of death when operating with/in explosive applications/atmospheres. ⊘ Operation is <u>not</u> permitted and is considered a misapplication!

	NOTE
	<ul style="list-style-type: none"> ▶ The device does <u>not</u> comply with Directive 2014/34/EU (ATEX). ▶ The device is <u>not</u> suitable for operation in potentially explosive surroundings or for conveying media that can form explosive mixtures.

Technical data

3 Technical data

3.1 Dimensions

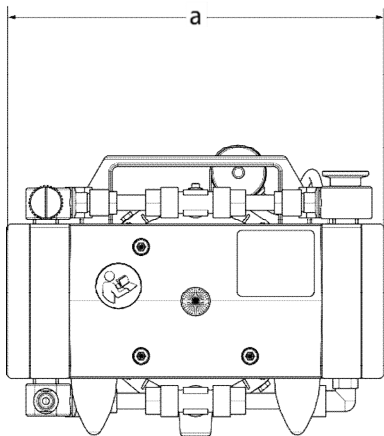

Fig. 3-1 Front view of device

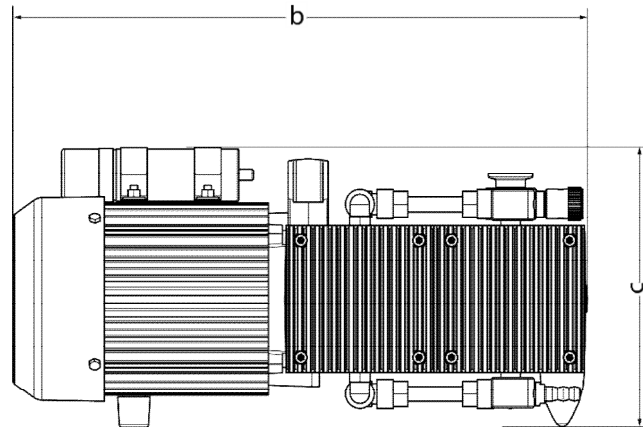

Fig. 3-2 Left view of device

ⓘ The main dimensions are identical for all models listed here.

Pos.	Parameters	Data
a	Width	≤ 250 mm
W	Depth	≤ 390 mm
c	Height	≤ 185 mm

3.2 Characteristic values

Pumping speed

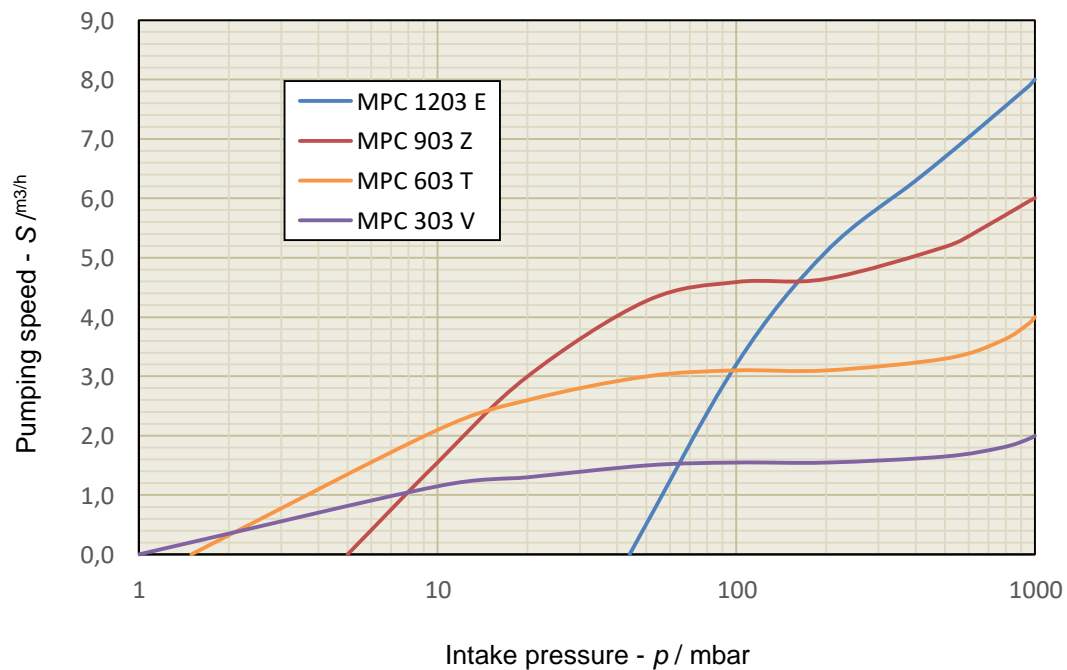

Fig. 3-3. Pumping speed characteristics $S(p)$

Parameters

Parameter	Unit	Data			
		415741 MPC 1203 E	415742 MPC 903 Z	415743 MPC 603 T	415744 MPC 303 V
Article no. Model					
Pumping speed ¹ (50/60 Hz)	m ³ /h	8,0 / 8,8	6,0 / 6,6	4,0 / 4,4	2,0 / 2,2
End pressure ¹ (base pressure) with gas ballast	mbar	≤ 55,0 ≤ 80,0	≤ 5,0 ≤ 8,0	≤ 1,5 ≤ 3,0	≤ 1,0 ≤ 3,0
Inlet/outlet pressure	mbar	≤ 1100			
Protection class ²	-	IP54/40			
Sound pressure level ³	db (A)	≤ 44			
Weight (net/gross)	kg	18,3			
Rated voltage	V	230 (1~)			
Rated frequency	Hz	50 / 60			
Rated current (50/60 Hz)	A	2,00 / 2,90			
Operating temperature range	°C	+10...+40			
Media temperature	°C	≤ +40			
Insert height	m (MSL)	≤ 1000			
Storage humidity	RH	< 90%			

¹ according to ISO 21360-1, 1000 mbar pumping speed

² according to EN 60034-5

³ according to EN ISO 2151

3.3 General Connections

	MAINS CONNECTION
	► The electrical connection must be carried out in accordance with the legal requirements of the respective country.

Type of connection	Version	Use for
Pneumatic Inlet (suction) Output (pressure side)	Clamping flange DN 16 KF Hose shaft DN 8	Clamping flange DN 16 KF Hose ID = 8 mm
Accompanying parts (optional) Inlet (suction)	Hose shaft DN 8-10	Hose ID = 8-10 mm
Mains connection	IEC 60320 C14	IEC 60320 C13

3.4 Materials

NOTE
 <ul style="list-style-type: none"> ▶ The operator must ensure that the application with the installed materials is not critical. ▶ Observe the safety/warning instructions (see chapter 2.4.1 <i>Hazardous substances</i>)!

Components in contact with media

Components	Material
Pumping unit (in contact with medium) <ul style="list-style-type: none"> • Pump heads • Diaphragm • Valves • Seals 	<ul style="list-style-type: none"> • PTFE • PTFE coating on elastomer • PEEK • EPDM
Pneumatic connections <ul style="list-style-type: none"> • Vacuum hoses • Screw fittings • O-ring seals 	<ul style="list-style-type: none"> • PTFE • PVDF • EPDM

4 Description

4.1 General information

	NOTE
	The station must be connected in accordance with the legal requirements and operated in compliance with the technical data.

Function

- The device is a dry-running diaphragm vacuum pump.
- By increasing and decreasing the displacement of the oscillating membrane in the pump head, gases are drawn in, compressed and expelled.

Scope of application

- The device is suitable for conveying neutral gaseous media.
- The device is suitable for use in laboratories and industry when working in rough vacuum conditions.

4.2 Design

The device is driven by an AC motor (1~) and consists of a pumping unit with four pump heads, which is designed in three pneumatic connections.

Pneumatic connections

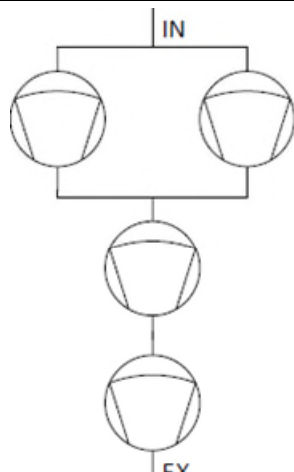
Article no. Model	Connection	Scheme
415744 MPC 303 V	Four stage	
415743 MPC 603 T	Three stage	

Description

Article no. Model	Connection	Scheme
415742 MPC 903 Z	Two stage	
415741 MPC 1203 E	Single stage	

4.2.1 Images of the device

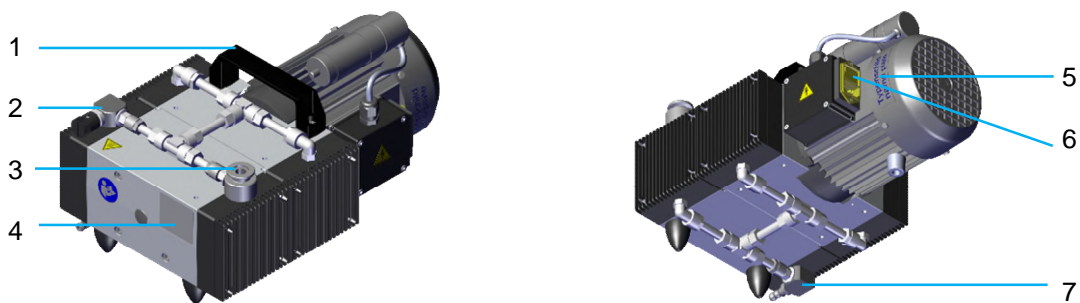

Fig. 4-1. Model MPC 1203 E, front (left) and rear (right) view

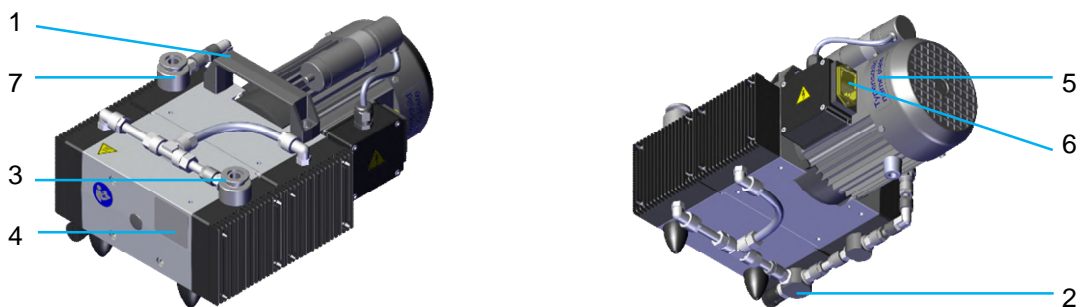

Fig. 4-2. Model MPC 903 Z, front (left) and rear (right) view

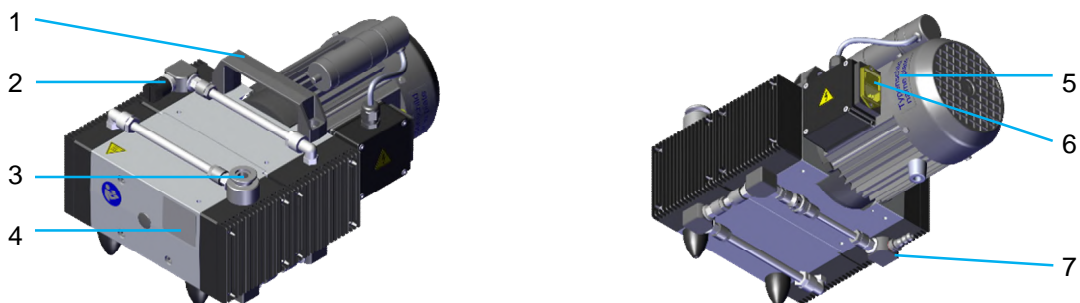

Fig. 4-3. Model MPC 603 T, front (left) and rear (right) view

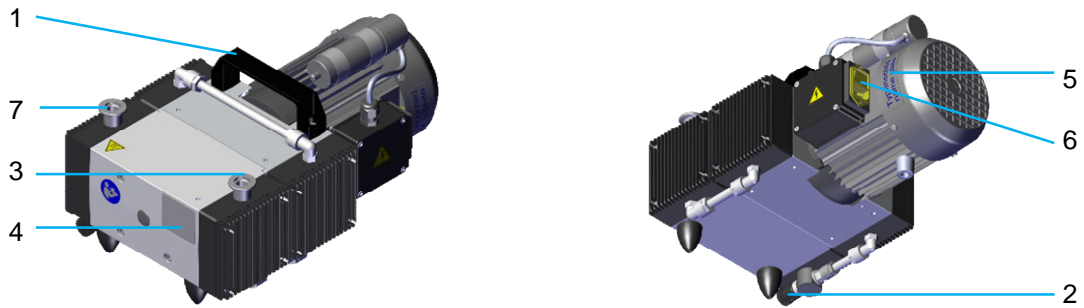



Fig. 4-4. Model MPC 303 V, front (left) and rear (right) view

ⓘ Display without accompanying material at the inlet (see chapter 3.3 *General Connections*).

Position	Description
1	Carrying handle
2	Gas Ballast
3	Inlet (pneum.) suction port
4	Entire device type plate
5	Type plate motor
6	Mains connection/ On/Off switch (see Fig. 5-1)
7	Output (pneum.) pressure side

4.2.2 Motor thermal protection

NOTE	
	<ul style="list-style-type: none"> ▶ Do not reset the thermal circuit breaker until the fault has been analysed. ▶ Notify Support if the fuse trips again (see chapter 8.4 <i>Repairs carried out by the manufacturer</i>).

The device is equipped with a thermal circuit breaker on the motor. This self-hold bimetal switch disconnects the entire device from the power supply in the event of overheating (see chapter 2.4 *Special hazards*).

Reset thermal circuit breaker:

1. Switch off the device.
2. Allow the engine to cool down completely.
3. Switch on the device.

4.2.3 Gas Ballast

The device is equipped with a gas ballast. When the gas ballast is opened, ambient air is sucked into the chamber at the last stage.

The gas ballast is intended to prevent the formation of condensate in the pump delivery area in applications with vapors (see chapter 2.3.2 *Safe operation*).

Open/close gas ballast

- Open: the marking on the black valve cap must face the same direction as the hose connection.
- Close: The marking on the black valve cap must be at a right angle to the hose connection.

Description

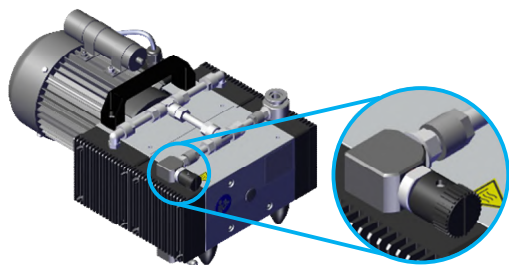

Fig. 4-5. MPC 1203 E

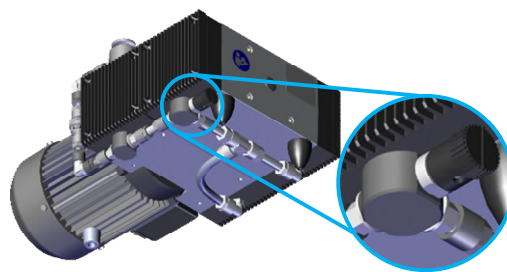

Fig. 4-6. MPC 903 Z

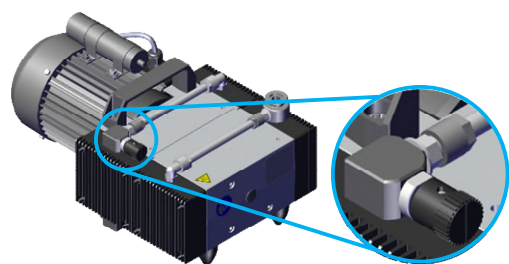

Fig. 4-7. MPC 603 T

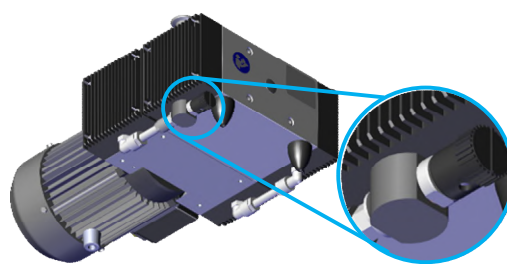



Fig. 4-8. MPC 303 V

 Images indicate gas ballast in closed condition.



4.3 Accessories







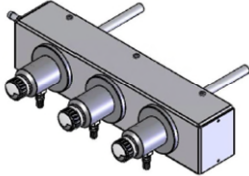
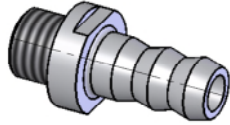
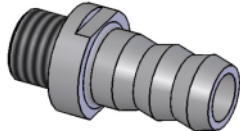

 The scope of delivery is defined by the supply contract.

4.3.1 Accompanying material

Image	Description
	Hose shaft (see chapter 3.3 <i>General Connections</i>)

4.3.2 Optional fittings

Order no.	Name	Image
600100	Vacuum controller VCpro 601 table-top device <ul style="list-style-type: none"> Measuring/control device Working range 1100 – 1 mbar Regulation via vacuum control/vent valve Operating modes: manual, automatic and programme 	
404005	Vacuum furnace connector set <ul style="list-style-type: none"> DN 16+25 KF DN 8 vacuum hose made from red rubber Adapter flange/hose nozzle. 	
700458	Vacuum dosing block w. DBR-A analogue pressure gauge <ul style="list-style-type: none"> DN8,G1/4"-M12x1 	

Order no.	Name	Image
700556	Mini network with three extraction modules	
710935-3	Hose connector • DN 10 male thread G 1/4", PVDF	
720331	Hose connector • DN 12 male thread G 1/4", PP	
828310-3	Vacuum hose • Red rubber, 20/10 x 5 mm	
828310-4	Vacuum hose • Rubber 18/8 x 5mm	
828332	Vacuum hose • PTFE, 10/8 x 1mm	
829984	Angle-ESV-PVDF • YAA 22421-10-1/4 PA CP	
826011-15	Clamping range hose clamp • D = 12-22 mm vz. 9 mm wide	
701011	KF standard aluminum clamping ring • DN 10/16	
701151	KF AI outer centering ring with FKM O-ring • DN10/16 on both sides	

 Further accessories available on request

5 Setting up and connecting

	NOTE
	<ul style="list-style-type: none">▶ Observe the safety/warning instructions (see chapter 2 <i>Security</i>).▶ Test the electrical safety of the device to rule out any damage during transport.

	<ul style="list-style-type: none">➤ The General Terms and Conditions of the manufacturer apply.➤ The scope of delivery is determined by the delivery contract.➤ Keep the packaging if the device is to be returned to the manufacturer's site or authorised workshops for repair.
---	---

5.1 Storage

The device must be stored in a dust-free and closed interior space. The conditions for storage must be observed (see chapter 3.2 *Characteristic values*).

	<ul style="list-style-type: none">➤ During storage all connections must be sealed with the protective caps supplied.➤ A different but equivalent closure can also be used for storage.
---	---

5.2 Unpack

Carefully unpack the device and check for:

- damage during transport,
- conformity with the specifications of the supply contract (type, connected loads),
- completeness of the delivery.

Inform us immediately if there are differences to the contractually agreed scope of delivery or if damage is apparent.

Remove all transport locks and adhesives from the device and remove the operating manuals and enclosed material from the packaging.

When making a warranty claim, the device must be returned in suitable packaging that is safe for transportation.

5.3 Set up

	NOTE
	<ul style="list-style-type: none">▶ Ensure sufficient ventilation or cooling.▶ The distance between adjacent parts and surfaces must be sufficient to prevent the device from overheating. The distance between the motor air inlet and walls, components, etc. must be at least 40 mm!▶ Place the device on a flat horizontal surface.

5.4 Assembly

There is no need to assemble the device, as it is already fully assembled. The device only needs to be connected (see chapter 5.5 *Connect*).

5.5 Connect

5.5.1 Connecting pneumatics

	NOTE
	▶ The pneumatic connection must be sound so that no leaks occur.

The following requirements apply to pneumatic connections:



- They must comply with chapter 3.3 *General Connections*.
- They must be flexible (see chapter 2.4.3 *Mechanics*).
- They must be suitable for vacuum application.
- They must always be free.
- They must not be kinked.
- The hose dimensions must be the correct size and the pumping capacity must not be impaired.
- Select the shortest connection length possible.
- Condensate in the pneumatic connections must always be capable of draining into the separators.

	Optional
	➤ Only use ready-made cables produced by the manufacturer. This prevents wrong connections (see chapter 4.3.2 <i>Optional fittings</i>).

Procedure

1. Connect the input (Fig. 4-1/3, Fig. 4-2/3, Fig. 4-3/3, Fig. 4-4/3).
2. Connect the output (Fig. 4-1/7, Fig. 4-2/7, Fig. 4-3/7, Fig. 4-4/7) if required.

5.5.2 Electrical connection

 DANGER	
	▲ Danger of death due to electric shock!
	△ If the device is <u>not</u> connected according to the legal requirements, it can lead to serious injuries and even death in the event of a fault during operation due to contact. <input type="checkbox"/> The electrical connection must be carried out in accordance with the legal requirements of the respective country.

Procedure

The device is supplied with a standard power cable that is connected at the mains connection (Fig. 5-1/2).

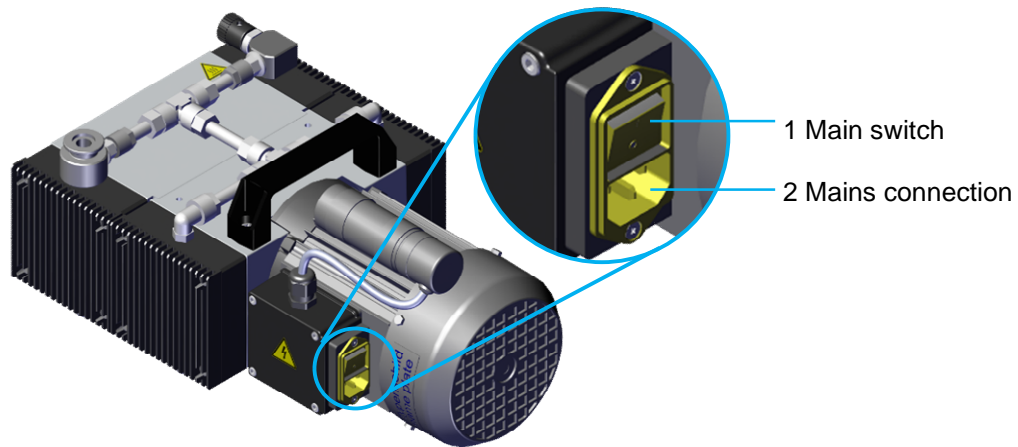



Fig. 5-1. Main switch and mains connection (rear view)

i Applies to both device models.

6 Operation

6.1 Commissioning

	NOTE
	▶ Observe the safety/warning instructions before commissioning (see chapter 2 <i>Security</i>).

	Storage
	<ul style="list-style-type: none"> ▶ When the device is brought to the installation site for commissioning after storage in a cold environment, condensation may occur. ▶ Wait at least one hour before switching on until the device has reached ambient temperature and is absolutely dry.

Procedure

1. Inspect the attachment parts for intactness.
2. Check all connections according to chapter 5.5 *Connect*.
3. Turn on the device at the main switch (Fig. 5-1/1).
4. Check the tightness of the pneumatic connections.
5. Check operating behaviour, e.g., for unusual running noises.

6.2 Safe operation

	SAFE OPERATION
	▶ Safe operation can only be guaranteed if the device is operated in accordance with chapter 2 <i>Security</i> and 3 <i>Technical data</i> .

Checking equipment regularly

- Unusual running noises
- Ensure all electrical and pneumatic connections are sealed tightly
- Pneumatic connection:
 - check for leaks
 - free from deposits
- Intactness of attachment parts

	NOTE
	▶ For vapor applications, the device must run down (see chapter 2.3.2 <i>Safe operation</i>)

7 Operational faults

OPERATING FAULTS INSIDE THE DEVICE
 <ul style="list-style-type: none"> ▶ To eliminate operating faults inside the device, the instructions and notes in chapter 8 <i>Maintenance</i> and 8.3 <i>Repairs carried out by the operator</i> must be observed! ▶ Authorisation for the elimination of operational faults must be taken into account in accordance with chapter 2.2 <i>Target groups</i>. The operator must enforce this!

Responsibilities

No.	Agent (authorised)
1	User
1a	Specially trained users
2	Specialist
3	Manufacturer

Eliminate operational faults



Type of error	Cause:	Action	Authorised
Vacuum pump does not start	Device switched off	Switch on the device (Fig. 5-1)	1
	Incorrect operating voltage	Check operating voltage according to chapter 3.2 <i>Characteristic values</i>	2
	No power supply	Check mains connection	2
	Mains cable defective	Replacing the mains cable ¹	2
	Thermal switch has been triggered	Reset according to chapter 4.2.2 <i>Motor thermal protection</i>	1
	Blocked drive	Change diaphragm ²	1a
	Defective drive	Notify Support ¹	3
	Defective motor	Notify Support ¹	3
Vacuum pump generates no or only insufficient vacuum	Connected apparatus, connection elements leaking	<ul style="list-style-type: none"> • Detect leaks • Seal the gaskets/hoses and replace if necessary. 	1
	Pumping unit leaking	Check if necessary seal / change pneumatic connections	1a
	Leaking pump head	Notify Support ¹	3
	Defective diaphragm	Change diaphragm ²	1a
	Defective valves	Change valve ²	1a
	Pumping unit is dirty	General maintenance / cleaning ³	1
	Dirty valves	Clean valves ³	1a
Noise coming from the pumping unit	Pumping unit is dirty	General maintenance / cleaning ³	1



¹ See chapter 9.2 *Contact details for Support* or to place an order

² See chapter 8.3 *Repairs carried out by the operator*

³ See chapter 8.2 *Maintaining by cleaning*



8 Maintenance

 WARNING	
 	<p>▲ Risk to health due to hazardous substances!</p> <p>△ Components that come into contact with media can be contaminated with hazardous substances through applications, which can endanger the health of persons.</p> <p><input type="checkbox"/> Affected components must be decontaminated before maintenance (servicing, inspection and repair); if necessary, further safety precautions must be taken.</p> <p><input type="checkbox"/> The operator must enforce decontamination and safety precautions (see chapter 2.3 <i>Safety precautions</i> and chapter 2.4.1 <i>Hazardous substances</i>)!</p>

 NOTE	
	<p>▶ The device must be disconnected from the mains before any repair work is carried out!</p>

 Additional safety precautions may be required for repairs (see chapter 2.3 *Safety precautions*). The specific measures are defined by the operator.

8.1 Maintenance and inspection



 MAINTENANCE/INSPECTION	
	<p>▶ The device <u>must</u> be serviced regularly in applications with media that affect the service life of materials.</p> <p>▶ For the safe operation of the device, the operator must prepare an application maintenance/inspection plan and enforce maintenance cycles.</p>

 Malfunctions and damage can occur due to blocked pipes at the exhaust or inlet. All connections must be free of deposits.

General information

- Regularly check the tightness of the system.
- Check that the pneumatic connection is not blocked, especially the outlet.
- Change the seals if necessary.
- Check that all connections are tight.
- Check the functionality of the vacuum pump, e.g. abnormal operating noises.

8.2 Maintaining by cleaning

 WARNING	
	<p>▲ Health hazard due to unintentional chemical reactions!</p> <p>△ Unsuitable cleaning agents can cause a health hazard by reacting with components in the device or the coating material.</p> <p><input type="checkbox"/> Do not use cleaning agents that react with components in the device or the coating material.</p> <p><input type="checkbox"/> The operator must assess the usability of cleaning agents.</p>

Maintenance

 CLEANING AGENTS
<ul style="list-style-type: none"> ▶ There is a risk of corrosion if cleaning agents containing acids or halides are used. ▶ Clean the device after each use to avoid possible corrosive damage caused by chemicals in the feed material.

 We recommend using only the cleaning agents specified in the operating manual.

Procedure

1. Switch off the station.
2. After cleaning, remove cleaning agents completely from surfaces with a damp cloth.
3. After any cleaning and decontamination precautions are taken, allow the device to dry completely before using it again.
4. Depending on the degree of contamination, clean components in contact with the media at regular intervals with a suitable solvent (such as acetone).
5. Wipe surfaces with a damp cloth. Additionally, we recommend the following cleaning agents:

Part of the device	Cleaning agents
Outer surfaces and motor housing	Standard commercial cleaning agents with no acid and halogenides, alcohol solutions
Hoses	Standard commercial cleaning agents with no acid and halogenides
Valves, pump head and diaphragm	Acetone with a soft cloth

8.3 Repairs carried out by the operator

 AUTHORISATION
<ul style="list-style-type: none"> ▶ Repairs may only be carried out by specialist personnel or specially trained users (see chapter 2.2.2 <i>Responsibilities</i>). ▶ The operator is responsible for ensuring that the repair is carried out properly.

 NOTE
<ul style="list-style-type: none"> ▶ The device must be disconnected from the mains before any repair work is carried out!

 Additional safety precautions may be necessary during repairs (see chapter 2.3 *Safety precautions*). The specific measures are defined by the operator.

Maintenance cycle

We recommend changing the diaphragm annually or every 8,000 operating hours. The operator must enforce monitoring procedures.

Spare parts

	Maintenance kit
<p>➤ The replacement parts for the pumping unit can be ordered as a maintenance kit (see chapter 9.1 Spare parts overview).</p>	

The following tools are needed:

- SW17 open-end spanner
- 4 and 5 mm allen key

8.3.1 Disassembly

Pumping unit (Fig. 8-1)

1. Loosen compression fittings (3) hoses (1).
2. Loosen the cap screws (10).
3. Remove the heat sink (9).
4. Pull the valve insert (8) out of the pump head (4). ⓘ M5 threaded insert.
5. Remove valves (5) and O-rings (6/7).
6. Remove the pump head (4).
7. Loosen the diaphragm (2) ⓘ anticlockwise
8. Clean the pump head (4) if necessary (see chapter 8.2 Maintaining by cleaning).
9. Drive function check.

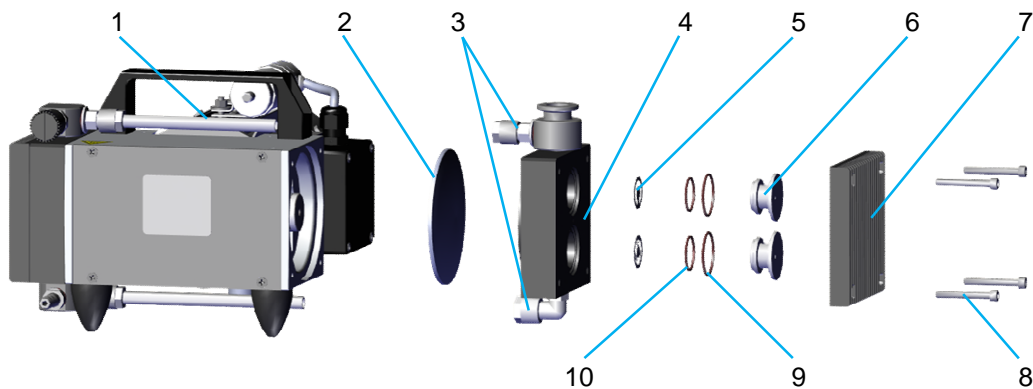

Fig. 8-1. Pumping unit (exploded view)

ⓘ To change the diaphragm, turn the pump heads upwards to a horizontal position.

Position	Description
1	Hoses
2	Diaphragm
3	Compression fittings
4	Pump head
5	Valves
6	Valve inserts
7	Heat sink
8	Cheese head screws
9	O-rings 28x2
10	O-rings 22x2

Maintenance

8.3.2 Assembly

Pumping unit (Fig. 8-1)

1. Mount the diaphragm (2) tightly by hand.
2. Move the connecting rod/diaphragm (2) to the centre position.
3. Put on the pump head (4).
 - ❗ Position the hose connection in the compression fitting.
4. Insert the O-rings (6/7).
5. Insert valves (5): ❗ Insert correctly to prevent leaks!
 - a. Ensure continuous support
 - b. Do not insert the burr side of the valve in the direction of the sealing surface.
6. Insert the valve inserts (8).
7. Put on the heat sink (9).
8. Tighten the cap screws (10) symmetrically.
 - ❗ Tighten to 3 to 4 Nm torque!
9. Tighten the compression fitting (3).



8.3.3 Functional test

	NOTE
	<ul style="list-style-type: none">▶ The device must not produce any abnormal noise or vibration.▶ Switch off the device immediately if it does <u>not</u> work properly.

Procedure

1. Connect the vacuum gauge directly to the suction connection of the device.
2. Measure and calibrate the end pressure (see chapter 3.2 *Characteristic values*).
 - ❗ The value is reached within 1 min. if the function is working properly.

8.4 Repairs carried out by the manufacturer

 WARNING	
	<ul style="list-style-type: none">▲ Health hazard due to contaminated components!△ Incomplete or incorrectly completed damage reports can endanger the health of service personnel.□ Provide full details in the damage report, especially with regard to the possible contamination of components in contact with media.

	SERVICE/REPAIR
	<ul style="list-style-type: none">▶ Service and repair at the manufacturer's site or in authorised workshops will only be carried out if the completed damage report including a decontamination declaration is submitted.▶ The indication of contamination or complete cleaning is a <u>legally binding</u> part of the contract.

- ❗ For transferring the device to the manufacturer, see chapter 9.2 *Contact details for Support* or to place an order.

Damage report

You can download the damage report form on our website www.welchvacuum.com in the "Service" menu under → ☒Damage reports".

If you do not have access to the internet, you can call us to request the form.

 +49 3677 604 0

8.5 Disposal

	NOTE
	<ul style="list-style-type: none">▶ Incorrect disposal can lead to environmental damage.▶ Disposal must be carried out in accordance with the legal requirements set out in Directive 2012/19/EU.▶ Contaminated devices must be decontaminated in accordance with legal requirements.

Spare parts

9 Spare parts

The spare parts list contains all the spare parts with the information required to place an order. When placing an order with us, please state the name, number of pieces, serial number, and the order number.

	LIABILITY
	▶ We are not liable for damage caused by the installation of parts not provided by the manufacturer Gardner Denver Thomas GmbH.

9.1 Spare parts overview

Designation / Content	Order Numbers
Maintenance kit (O-rings, valves, diaphragms)	402056

 The maintenance kit is the same for all device models described

9.2 Contact details for Support or to place an order

Manufacturer

Gardner Denver Thomas GmbH
Am Vogelherd 20
98693 Ilmenau
Germany

Contact

	+49 3677 604 0 (Customer Support)
	+49 3677 604 131
	welch.emea@irco.com 
	www.welchvacuum.com 

10 Annex:

10.1 EU Declaration of Conformity

Translation of the original declaration (German)

Gardner Denver Thomas GmbH
Am Vogelherd 20
98693 Ilmenau
Germany



We hereby declare that we are responsible for the following product and due to its design and construction, and the documents which we have placed on the market, complies with the EU directives and standards listed below. In the event of a product modification to which we have not agreed, this declaration shall lose its validity.

Product description		
Type of device	4-head diaphragm vacuum pump	
Model / Article no.	MPC 1203 E MPC 903 Z MPC 603 T MPC 303 V	415741 415742 415743 415744

The product complies with the following directives and standards	
2006/42/EC	EN ISO 12100:2010 / EN 1012-2:1996+A1:2009
2011/65/EU	EN IEC 63000:2018

Person authorised to produce this declaration on behalf of the manufacturer:

Place, date: Ilmenau, 26.02.2024

Tobias Kraft
 Plant Manager

ppa. Tobias Kraft

Person established in the European Union authorised to compile the technical file.

Gardner Denver Thomas GmbH
 Am Vogelherd 20
 98693 Ilmenau
 Germany

+49 3677 604 0

+49 3677 604 131

welch.emea@irco.com

www.welchvacuum.com

Additional information:

The device described above is inherently harmless with regard to electromagnetic compatibility and thus does not fall within the scope of Directive 2014/30/EU according to Article 2(2) d).

10.2 Notes

Gardner Denver Thomas GmbH
Am Vogelherd 20
98693 Ilmenau
German