

Operation Manual (EN)
Translation of the original operation manual

Welch VCpro 600 Series Vacuum Controller

Device models:

- ▶ VCpro 601
Vacuum control valve
- ▶ VCpro 602
Motor speed control



Manufacturer

Gardner Denver Thomas GmbH

Am Vogelherd 20

98693 Ilmenau

Germany

T +49 3677 604 0

F +49 3677 604 131

welch.emea@gardnerdenver.com

www.gardnerdenver.com/welch

Customer support +49 3677 604 0

Imprint

© 2019

Reprint or duplication, also in excerpt, are not permitted without written approval from Gardner Denver Thomas GmbH.

All rights under the copyright laws are expressly reserved by Gardner Denver Thomas GmbH.

We reserve the right to make changes and amendments.

Contents

1	Important Information	5
1.1	Note for the user/personnel	5
1.2	Depiction of warning notices and information	5
1.3	Explanations of safety symbols.....	6
1.4	Legend for the abbreviations	7
2	Safety.....	8
2.1	General	8
2.2	Use.....	8
2.2.1	Proper use.....	8
2.2.2	Improper use.....	8
2.2.3	Foreseeable misuse.....	9
2.3	Target groups.....	9
2.3.1	Personnel qualification.....	9
2.3.2	Overview of the responsibilities	9
2.4	Protective measures	10
2.5	Special hazards	10
2.5.1	Hazardous materials in general	10
2.5.2	Explosive gases	11
2.5.3	Electricity.....	11
2.5.4	Mechanics.....	12
2.5.5	Vacuum	12
2.5.6	System functions.....	12
2.6	Network safety	13
3	Technical data.....	14
3.1	Properties.....	14
3.2	Interfaces	15
3.3	Pneumatic connections.....	16
3.4	Parts in contact with internal gas	16
4	Description.....	17
4.1	Function	17
4.2	Set-up.....	17
4.3	Operating elements and navigation of the vacuum controller	18
4.3.1	Operating elements and display	18
4.3.2	Navigation	21
4.4	Device models	21
4.4.1	Vacuum controller VCpro 601 (vacuum control valve)	21
4.4.2	Vacuum controller VCpro 602 (motor speed control)	22
4.5	Explanation of the symbols	23
4.6	Interfaces	24
4.7	Accessories (options).....	24
5	Assembly and installation	25
5.1	Unpacking	25
5.2	Set-up and connection	25
5.3	Electrical connection	25
5.4	Communication interfaces	26
5.5	Storage.....	26
6	Operation.....	27
6.1	Start-up	27

Contents

6.2	Operating modes and system settings	27
6.2.1	Operating mode 1 Manual.....	27
6.2.2	Operating mode 2 Automatic	28
6.2.3	Operating mode 3 Program.....	29
6.2.4	Operating mode 4 Multi-pump.....	30
6.2.5	Operating mode 5 Self-cleaning.....	30
6.2.6	System settings	31
6.3	Configuring the vacuum controller	35
6.3.1	Access control	35
6.3.2	Log files	35
6.3.3	Reset to factory settings.....	36
6.4	"PC-Control 601" PC software (Option)	36
6.4.1	Installation	36
6.4.2	Connection settings.....	37
6.4.3	Main screen.....	38
6.4.4	File.....	39
6.4.5	Log files	40
6.4.6	Settings	42
6.4.7	Calibrate	43
6.4.8	Firmware update	44
6.5	Solvents table.....	45
7	Maintenance and service.....	46
7.1	Cleaning	46
7.2	Disposal.....	46
7.3	Damage report	46
8	Elimination of operating faults.....	47
9	Spare parts overview	49
9.1	Spare parts list vacuum controller.....	49
9.2	Ordering and service contact	50
10	Appendix.....	51
10.1	EU declaration of conformity	51
10.2	Notes	52

1 Important Information

	ATTENTION
	<ul style="list-style-type: none"> ▶ Read operation manual carefully before use. ▶ Keep operation manual for later reference.

1.1 Note for the user/personnel

Safety

- The user/personnel must have read and understood the operation manual completely before starting work.
- The operation manual must always be kept in the place it will be used and be available to the user/personnel.
- The product may not be transferred without the operation manual.
- Safe operation can only be guaranteed with proper and correct use of the product. The safety instructions must be heeded!

General information



- For simplification, the vacuum controller (VCpro) will be called the device below.
- Vacuum apparatus/vacuum system generally describes a combination of components for vacuum applications, such as rotary evaporator with vacuum controller and vacuum pump.
- The operator is responsible for the proper use of vacuum apparatuses/vacuum systems.

1.2 Depiction of warning notices and information

The warning notices are depicted as follows:

Additional symbols	 DEGREE OF RISK
	<ul style="list-style-type: none"> ▶ Warning about possible hazards. ▶ Consequences if warning is not heeded. ▶ Heed note to prevent!

Degree of risk



 DANGER	▶ Indicates a threatening risk that results in dangerous injuries or death.
 WARNING	▶ Indicates a possibly hazardous situation which, if not avoided, can result in serious injuries or life-threatening consequences.
 CAUTION	▶ Indicates a possibly hazardous situation. If it is not avoided, it can result in slight injuries.

Depiction of information

Additional symbol	SIGNAL WORD
	▶ Important information for the user/operator.

Important Information

1.3 Explanations of safety symbols

	▶ General warning symbol
	▶ High voltage warning
	▶ Explosive materials warning
	▶ Hot surface warning
	▶ Poisonous substances warning
	▶ General prohibition
	▶ General mandatory sign
	▶ Disconnect from power
	▶ Protective clothing – gloves
	▶ Protective clothing – goggles
	▶ Heed operating instructions
	▶ Components jeopardized by electrostatic discharge ESD
	▶ General information

1.4 Legend for the abbreviations

Abbreviation	Designation or meaning	Explanation
A	Ampere - current strength	Electrical unit
abs	absolute	Value specification
AC	Alternating current	Electrical unit
ATM	Atmosphere	Pressure specification
DC	Direct current	Electrical unit
DN	Nominal diameter – inner diameter (French: diamètre nominal)	Dimension specification
EPDM	Ethylene propylene diene rubber	Material
EX	Exhaust	Connection designation
FFKM	Perfluorinated rubber	Material
FKM	Fluorinated rubber	Material
FS	Full scale	Scale end value
FSS	Level sensor (German: Füllstandssensor)	Component
hh:mm:ss	hour / minute / second	Time specification
hPa	Hektopascal (1 hPa = 1 mbar = 0.75 Torr)	Pressure unit
Hz	Hertz - frequency	Electrical unit
IN	Intake	Connection designation
LVS	Labor vacuum system	Device model
max.	Maximum	Value specification
mbar	Millibar (1 mbar = 1 hPa = 0.75 Torr)	Pressure unit
min.	Minimum	Value specification
mm	Millimeter	Dimension specification
MPC	Diaphragm pump, chemically resistant	Device model
PP	Polypropylene	Material
PVDF	Polyvinylidene fluoride	Material
r.F.	Relative humidity (German: relative Feuchte)	Environmental condition
RPM	Rotation per minutes	Mechanical unit
Torr	Torr (1 Torr = 1.33 mbar = 1.33 hPa)	Pressure unit
V	Volt - voltage	Electrical unit
VCpro	Vacuum controller	Device model
W	Watt – power	Electrical unit
WV	Water valve	Component

2 Safety

2.1 General

- Anyone who will use the device must have read and understood the following safety and warning notices.
- All activities may only be performed by trained personnel who are familiar with the special hazards and heed them and who have understood the functioning and operation manual of the vacuum controller.
- The device may only be used if it is in technically perfect condition.

2.2 Use

2.2.1 Proper use

The vacuum controller is a device, which with adjustable parameters, is used for control of an absolute pressure between normal pressure and 1 mbar for vacuum applications in the industrial sector and laboratories.

The device is only to be used indoors and may not be used in potentially explosive atmosphere.

Operation of the device is only permissible under the conditions described

- in Chapter 3 *Technical data*,
- on the type plate,
- and in the technical specification for the order in question.

Furthermore, proper use includes:

- Heeding the warning/safety measures in this operation manual and of the connected devices
 - Heeding the operation manual
 - Adherence to the operation manuals for connected vacuum pumps and laboratory vacuum systems from Gardner Denver Thomas GmbH
 - Use of approved spare parts and accessories from Gardner Denver Thomas GmbH
- **Any other use will be regarded as improper!**

2.2.2 Improper use

	 CAUTION
	<ul style="list-style-type: none">► With proper use, personal injury or property damage can occur.► The operator must ensure proper operation!

The following is regarded as improper use:

- Use that does not correspond to the proper use
- Use outside of the specifications of the technical data, the type plate or the conditions named in the delivery contract
- Operation in less-than-perfect technical condition
- Operation with missing or defective protective equipment
- Operation outdoors

Uses that are improper must be prevented by the operator or measures must be taken that ensure proper operation!

2.2.3 Foreseeable misuse

	ATTENTION
	▶ Misuse is generally FORBIDDEN . It also counts as improper!

Regarded as foreseeable misuse are the following:

- Operation in explosive atmospheres
- Conveying of critical gas (outside of the specifications in section 6.5 Solvents table)
- Manipulation of the software and hardware, such as impermissible attachments and modifications
- Leaving critical applications unsupervised
- Operation of the device with tools or other impermissible objects

2.3 Target groups

	ATTENTION
	▶ There can be misuse due to use by untrained personnel. ▶ The operator must ensure that the personnel is trained properly and all necessary safety measures are adhered to!

2.3.1 Personnel qualification

Target group	Area of activity
User	Laboratory personnel, e.g. chemists
Specialized personnel	Person with professional qualification as a mechanic, electrician and/or with laboratory devices
Manufacturer or authorized workshop	Service and maintenance / service only by manufacturer or authorized workshops / service providers

2.3.2 Overview of the responsibilities

Activity	User	Specialized personnel	Manufacturer / workshop
Set-up	x	x	x
Bringing into service	x	x	x
Operation	x	x	x
Calibration of sensors	x	x	x
Calibration of sensors at the factory			x
Factory settings		x	x
Fault message	x	x	x
Troubleshooting	x	x	x
Elimination of pneumatic faults	x	x	x
Elimination of electrical faults		x	x
Network integration		x	x
Software update		x	x
Data import/export	x	x	x
Data logger download	x	x	x
Repair order		x	x

Safety

Activity	User	Specialized personnel	Manufacturer / workshop
Service (cleaning)	X	X	X
Replacement of spare parts	X	X	X
Decommissioning		X	X
Decontamination *		X	X

*or having this done by qualified and authorized service providers

2.4 Protective measures

All protective measures must be the highest priority in order to protect the life and health of personnel. In case of potential safety hazards, these must be assessed and measures taken to avoid hazards. Uses that endanger health and life are not permitted.

Applicable operating instructions from the operator and the national regulations for accident prevention, safety and occupational safety must be heeded.

 PROTECTIVE CLOTHING
<ul style="list-style-type: none"> ▶ For applications that require protective clothing, this clothing must be worn for personal safety. ▶ The operator must specify the type and manner of protective clothing!

2.5 Special hazards

 EMERGENCY SWITCH OFF
<ul style="list-style-type: none"> ▶ In dangerous situations, de-energize the device by pressing the power switch or disconnecting the power plug.

 DE-ENERGIZED
<p>When de-energized:</p> <ul style="list-style-type: none"> ▶ VCpro 601 model: all valves are closed ▶ VCpro 602 model: motor stops

2.5.1 Hazardous materials in general

 WARNING
<ul style="list-style-type: none"> ▶ Hazardous materials in the medium to be conveyed can cause personal injuries and property damage. ▶ Heed the warning and safety instructions for handling hazardous materials!

 HAZARDOUS MATERIALS
<ul style="list-style-type: none"> ▶ For applications with materials with H and P classes, measures must be taken to protect the health of people and the environment. ▶ The operator must – taking into account the applicable regulations – assess the possible hazards in order to prevent personal injuries and damage to the environment and property. The operator bears responsibility for this!

For applications with hazardous materials, the following must be heeded:

- Adhere to the requirements of the manufacturer's safety data sheets for hazardous materials.
- Prevent the escape of poisonous and environmentally-damaging substances from the apparatus.
- To protect the environment and the apparatus, use a separator (e.g. condenser).
- Check the strength and leak tightness of the connecting lines.
- Check the proper installation of the sensor in the vacuum apparatus.

	SERVICE / REPAIR
	<ul style="list-style-type: none"> ▶ Service and repair by the manufacturer or in authorized facilities only with transfer of the completely filled-out damage report with decontamination declaration.



The damage report form is available for download from our website www.gardnerdenver.com/welch on the "Service" menu → "Damage reports".

2.5.2 Explosive gases



The device is not suited for operation in areas subject to explosion or the conveying of media that can form explosive mixtures.

The device is not certified according to ATEX directive 2014/34/EU.

When using the device in areas subject to explosion, the system operator is obligated to adhere to the ATEX 137 directive 1999/92/EC.

 	⚠ DANGER
	<ul style="list-style-type: none"> ▶ Caution, risk of explosion due to critical applications. ▶ With use of the device in an atmosphere subject to explosion or in applications where explosive mixtures can form, there is danger to life. ▶ The operator must ensure that the application may not be used in potentially explosive atmosphere!

2.5.3 Electricity

 	⚠ DANGER
	<ul style="list-style-type: none"> ▶ There is danger to life when opening the device. Touching exposed electrical conductors can cause immediate death. ▶ Opening the device is generally forbidden; this may only be done by specialists. ▶ Before opening the device, disconnect the power plug!

Heed the following instructions:

- Operating the device without the housing is forbidden.
- Only the manufacturer, authorized workshops or trained personnel may change the power supply, display or printed circuit board.
- If the device is defective, switch it off and disconnect the power plug.
- Use only the included standardized power plug in accordance with IEC 60320-C13. The power plug and cable must be in perfect condition.
- The electrical network must have protective conductors in accordance with IEC 60364-4-41. The protective conductor may not be interrupted.
- Note that the controller must be regarded as a portable tool.

Safety

2.5.4 Mechanics

	ATTENTION
	<p>▶ In case of improper use or manipulation of the device, there can be property damage to the connected vacuum pump or vacuum apparatus!</p>

Operate the device only according to the operation manual and the instructions in the operation manuals for the connected devices!

Operation with overpressure is not permitted with the device.

Solid and liquid materials in the gas to be conveyed can compromise the function of the sensor. Prevent the penetration of solid particles into the vacuum apparatus.

2.5.5 Vacuum

	WARNING
	<p>▶ Hazard due to sudden ventilation of the vacuum apparatus.</p> <p>▶ Due to sudden ventilation, the vacuum apparatus can explode.</p> <p>▶ Prevent sudden ventilation. Check the pressure in the vacuum apparatus before you disconnect the pneumatic connections. The vacuum apparatus can also be under vacuum when the device is switched off.</p>

Glass equipment is especially at risk. Make sure that it is vacuum-proof and non-breakable!

2.5.6 System functions

The following settings for the "control systems" must be assessed separately for particular vacuum applications, see *Chapter 6.2.6 System settings*:

"Allow ventilation"

- When this function is activated, it is possible that ambient air will get into the applications. This can cause uncontrolled reactions.
- Note that an inert gas must be connected to the ventilation valve if necessary.
- By activating the function, gas, possibly ones damaging to health, can escape from the application into the environment!

"Auto Start"

- If the "Auto Start" function is activated, the device starts automatically after a power failure or when the power switch is pressed. This can cause undesired after-effects in your application.
- An automatic start only occurs if an operating mode was started previously.
- Make sure that critical applications are not unsupervised!

	WARNING
	<p>▶ Activating the "Auto start" parameter in the system setting can result in hazards for the user and his environment.</p> <p>▶ Check system settings with automatic start-up function and assess possible hazards for your application!</p>

Both system settings are not activated in the factory setting. Before you activate the functions, make sure that there is no hazard with your application. The operator must assess possible hazards in order to guarantee the safety of users!

Unauthorized activation of the functions can be prevented with the ADMIN password, see *Chapter 6.3.1 Access control*.

2.6 Network safety



ATTENTION

- ▶ **The vacuum controller is network-capable via the LAN connection. This introduces the possibility of external access to the vacuum controller. Unauthorized access can cause manipulation of the applications.
The operator must guarantee network security in order to prevent undesired access to the vacuum controller.**

3 Technical data

3.1 Properties

Parameters	Data		Unit
Device model	VCpro 601	VCpro 602	
Item number	600100	600101	

Whole device		
Degree of protection	IP 20	-
Operating temperature	+ 15 ... + 30	°C
Rated voltage	115 ... 240	V AC
Rated power	40	W
Frequency	50 / 60	Hz
Output voltage power supply	24	V DC
Device fuse	T 630	mA
Dimensions (W/D/H)	195 / 178 / 105	mm
Weight	1.5	kg
Storage temperature	+ 10 ... + 40	°C
Storage humidity	max. 90 %	r.F.

Vacuum controller (internal)			
Switching/regulation precision	± 1		digit
- Vacuum control valve Voltage / power / resolution	24 / max. 16 / 1	-	V / W / bits
- Motor speed control Voltage / resolution	-	0 – 10 / 8	V / bits
- Pressure sensor Voltage / resolution	5 / 12		V / bits
- Ventilation valve Voltage / power / resolution	24 / 2 / 1		V / W / bits
- Water valve Voltage / power / resolution	24 / max. 4 / 1		V / W / bits
- Level sensor Voltage / resolution	24 / 1		V / bits

Parameters	Data	Unit
Pressure sensor (internal)		
Sensor type	capacitive	-
Measurement range	1 - 1100	mbar
Precision in total linearity, hysteresis and reproducibility	< ± 0.3 % FS	-

3.2 Interfaces

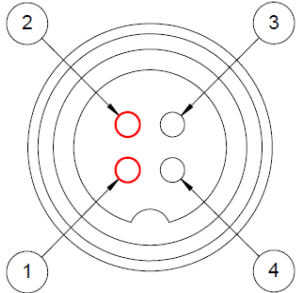
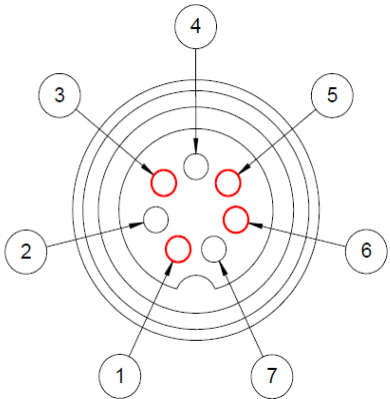
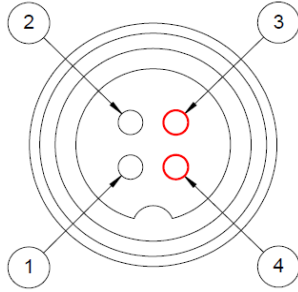
Control connections	Connection type	Pin assignment
IN/ OUT: Serial	RS 232, 9-pin D-Sub plug	-
IN/ OUT: LAN	RJ 45, min. CAT 6	
OUT: Vacuum control valve	With the VCpro 601 model, the vacuum control valve is integrated.	
OUT: Water valve	Binder outlet 4-pin	 <ul style="list-style-type: none"> 1 +24 V 2 GND 3 N/A 4 N/A
OUT: Level sensor	Binder outlet 7-pin	 <ul style="list-style-type: none"> 1 Signal sensor 2 N/A 3 GND (L-) 4 N/A 5 +24 V (L+) 6 Teach 7 N/A
OUT: Motor speed control	Binder outlet 4-pin	 <ul style="list-style-type: none"> 1 N/A 2 N/A 3 0-10 V 4 GND <p>NOTE Control connection only for the VCpro 602 model.</p>

Technical data

3.3 Pneumatic connections

Connections	Connection type
Connection: Inert gas (ventilation valve)	Hose nozzle DN 4
Connection: Vacuum apparatus	Hose nozzle DN 8
Connection: Vacuum pump	

3.4 Parts in contact with internal gas

Components	Material
Valve block including hose nozzles	PP
Vacuum control valve	PVDF, PTFE
Ventilation valve including inert gas hose nozzle	FKM, stainless steel
Backflow-stop valve (internal)	FFKM
Pressure sensor including seal	Aluminum oxide ceramic, EPDM

ATTENTION	
	<ul style="list-style-type: none"> ▶ The user must ensure that the application is not critical with the installed materials. ▶ Heed the safety instructions see <i>Chapter 2.5.1 Hazardous materials in general</i>.

4 Description

4.1 Function

The VCpro 600 series vacuum controller is a measurement and control/regulation device for vacuum processes. The regulation and control is done by inputting parameters for "set-points" and the querying of the "actual values". This allows a regulation and monitoring of the vacuum processes in various operation modes:

- Vacuum pressure regulation in a pressure range from **1100 to 1 mbar**
- Vacuum pressure regulation **VCpro 601**: via an electromagnetic vacuum control valve
- Vacuum pressure regulation **VCpro 602**: via an external motor speed controlled vacuum pump
- Ventilation of the system via the **sensor ventilation valve** subassembly as component of the vacuum controller, if necessary also with inert gas (inert gas connection DN4 on the device rear)

4.2 Set-up

The vacuum controller has a metal housing (3). The operating and display elements (9) are arranged on the front of the device.

On the rear are the ventilation valve with inert gas connection and for the device models:

- **VCpro 601**, the electromagnetic vacuum control valve
- **VCpro 602**, the control wire connection for the motor speed control

On the right side of the device are the power socket (7) with device main switch I/O (8), the RS 232 PC connection (5) and the RJ 45 LAN connection (6).

The vacuum pump (2) and vacuum apparatus (1) are connected using the hose nozzles.

Depending on the device model (VCpro 601 or VCpro 602), the outputs are assigned for electromagnetic vacuum control valve for regulating the vacuum, or for the vacuum pump motor, using an analog voltage for motor speed regulation (0 – 10 V).



Description

Pos.	Designation
1	Vacuum apparatus – connection
2	Vacuum pump – connection
3	Metal housing
4	Electromagnetic vacuum control valve (only VCpro 601 model)
5	RS 232 PC connection
6	RJ 45 LAN connection
7	Power socket
8	Device main switch I/O
9	Operating and display elements

OPERATING ELEMENTS: see Chapter 4.3.1 Operating elements and display

EXPLANATION OF THE SYMBOLS: see Chapter 4.5 Explanation of the symbols

OPTIONALLY available: see Chapter 4.7 Accessories (options)

- Water valves WV
- Level sensor FSS

The optional units can be connected using the following connection sockets see Chapter 3.2 Interfaces:















- Water valve connection WV
- Connection for level sensor FFS

The optional units are controlled with the vacuum controller.



4.3 Operating elements and navigation of the vacuum controller

4.3.1 Operating elements and display



Pos.	Symbol	Designation / function	Explanation
1	Toolbar		
		Vacuum control valve	Lights up if valve is open.
		Ventilation valve	Lights up if valve is open.
		Motor	Device model VCpro 602: The relative motor speed is displayed in percent on the motor symbol.
		Cooling water valve	Lights up if valve is open.
		Fluid catchpot	Lights up if the level sensor (optional) is triggered.
		Serial interface	Lights up when the device is connected to the PC software via RS232.
		LAN interface	Lights up when the device is connected to the PC software via LAN.
		Warning	When maintenance is due
2	Display - display field		
	▼ 0	Pressure – setpoint	Depiction in real time (top left)
	44.0	Pressure – actual value	Depiction in real time
	≤ / ≥	Less than-equal to Greater than-equal to	Actual value is outside of the range depicted (bottom left)
	00:00	Time	hh:mm (top middle)
3	Navigation bar		
		Manual	<i>See Chapter 6.2 Operating modes and system settings</i>
		Automatic	
		Program	
		Multi-pump	
		Self-cleaning	
		System settings	
4	Button bar		
		VENT	Ventilation of the system: <ul style="list-style-type: none"> ➤ Opens the ventilation valve if the operating mode is not active ➤ Opens the ventilation valve for the time when pressed, in active operating mode

Description

Pos.	Symbol	Designation / function	Explanation
		PMIN	<p><i>Primary function:</i></p> <p>Device model VCpro 601: Vacuum control valve opens.</p> <p>Device model VCpro 602: Maximum pressure drop at 100 % motor speed.</p> <p><i>Secondary function:</i> Pressure input: table with solvents appears on the screen.</p> <p>NOTE See Chapter 6.5 Solvents table</p>
		START / STOP	Start and stop the active operating mode selected.
		BACK	<p><i>Primary function:</i> Input: back Navigation: one level up</p> <p><i>Secondary function:</i> Change between numeric and graphic display in active operating mode.</p>
5	Rotary encoder		
		TURN	<p><i>Primary function:</i></p> <ul style="list-style-type: none"> ➤ Selection of operating mode ➤ Selection of row/column in the parameter table <p><i>Secondary function:</i></p> <ul style="list-style-type: none"> ➤ Adjust parameter value ➤ Change pressure setpoint in active operating mode manual
		PRESS	<p><i>Primary function:</i></p> <ul style="list-style-type: none"> ➤ Selection of selected operating mode ➤ Selection of parameter value <p><i>Secondary function:</i></p> <ul style="list-style-type: none"> ➤ Confirmation of set parameter value ➤ Confirmation <OK> dialog field ➤ Change pressure setpoint in active operating mode manual

4.3.2 Navigation

The user interface for the vacuum controller features three levels:

Level	Description
A	Start window
B	Parameter for the operating mode/system settings
C	Active operating mode

On the start window (level A), the operating mode of system setting is selected with a **TURN** of the rotary encoder. The selection in the parameter table of the operating mode or the system setting (level B) is made with the rotary encoder by **PRESSING**. To adjust the parameters see *Chapter 6.2 Operating modes and system settings*.

Use the **START / STOP** button to change to the active operating mode (level C). If an operating mode is selected on the start window (level A) and the **START / STOP** button is pressed, then the selected operating mode is activated directly (level C).

In active operating mode, the display can be changed between *numeric* and *graphic* display by pressing the **BACK** button. You can change between the display types at will during operation.

4.4 Device models

4.4.1 Vacuum controller VCpro 601 (vacuum control valve)

Figure	Pos.	Description
	1	Interface: RS 232
	2	Device complete
	3	Connection: vacuum pump
	4	Connection: vacuum apparatus
	5	Connection: level sensor
	6	Connection: water valve
	7	Ventilation valve
	8	Connection: inert gas
	9	Sensor, integrated
	10	Backflow-stop valve, integrated
	11	Vacuum control valve
	12	Power socket
	13	Device fuse
	14	Device main switch
	15	Interface: RJ 45 LAN

Description

Schematic diagram – connection of the vacuum controller VCpro 601

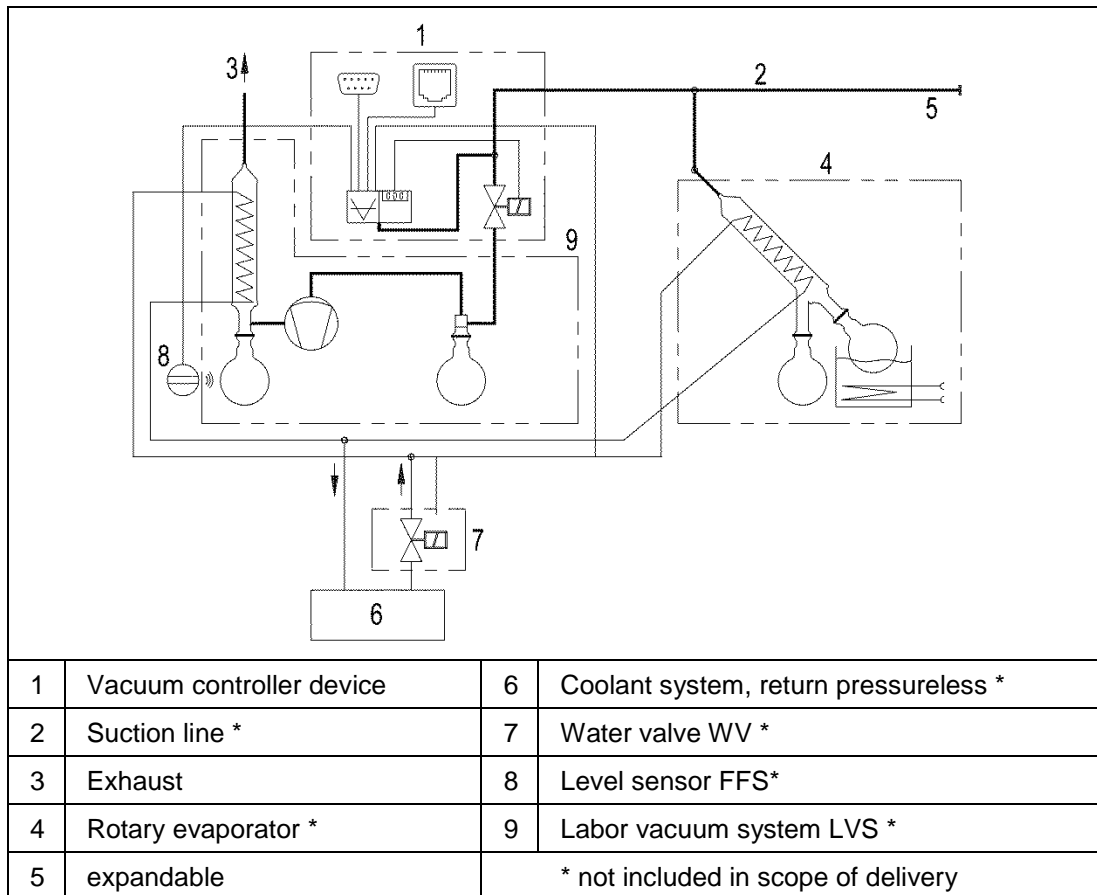

4.4.2 Vacuum controller VCpro 602 (motor speed control)

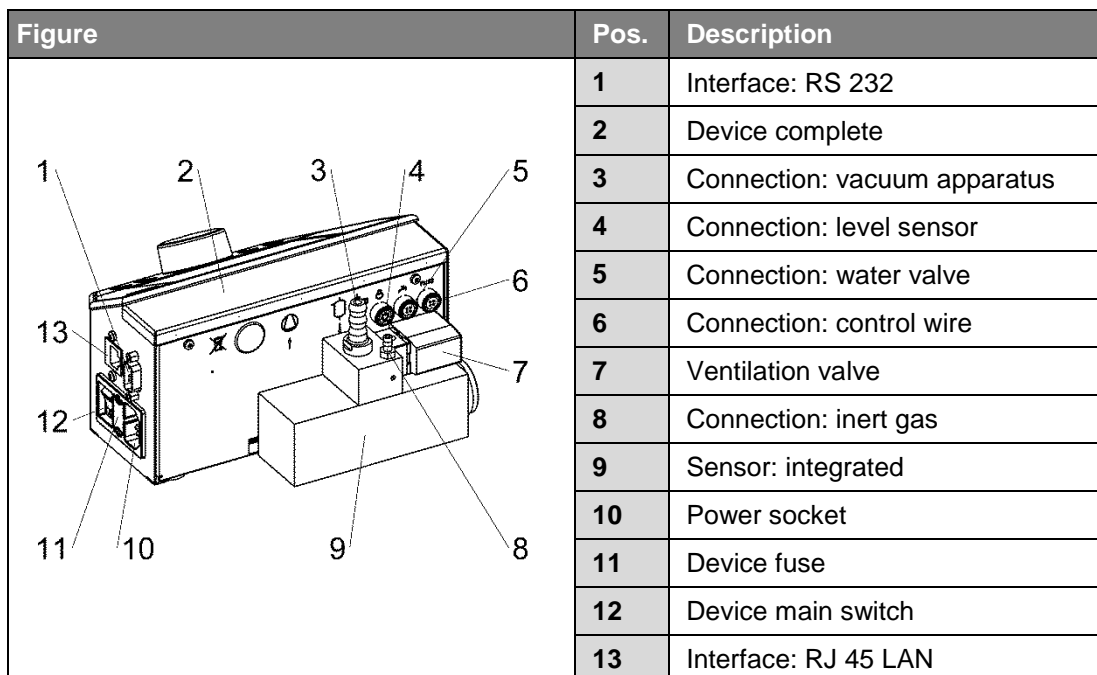

Schematic diagram – connection of the vacuum controller VCpro 602

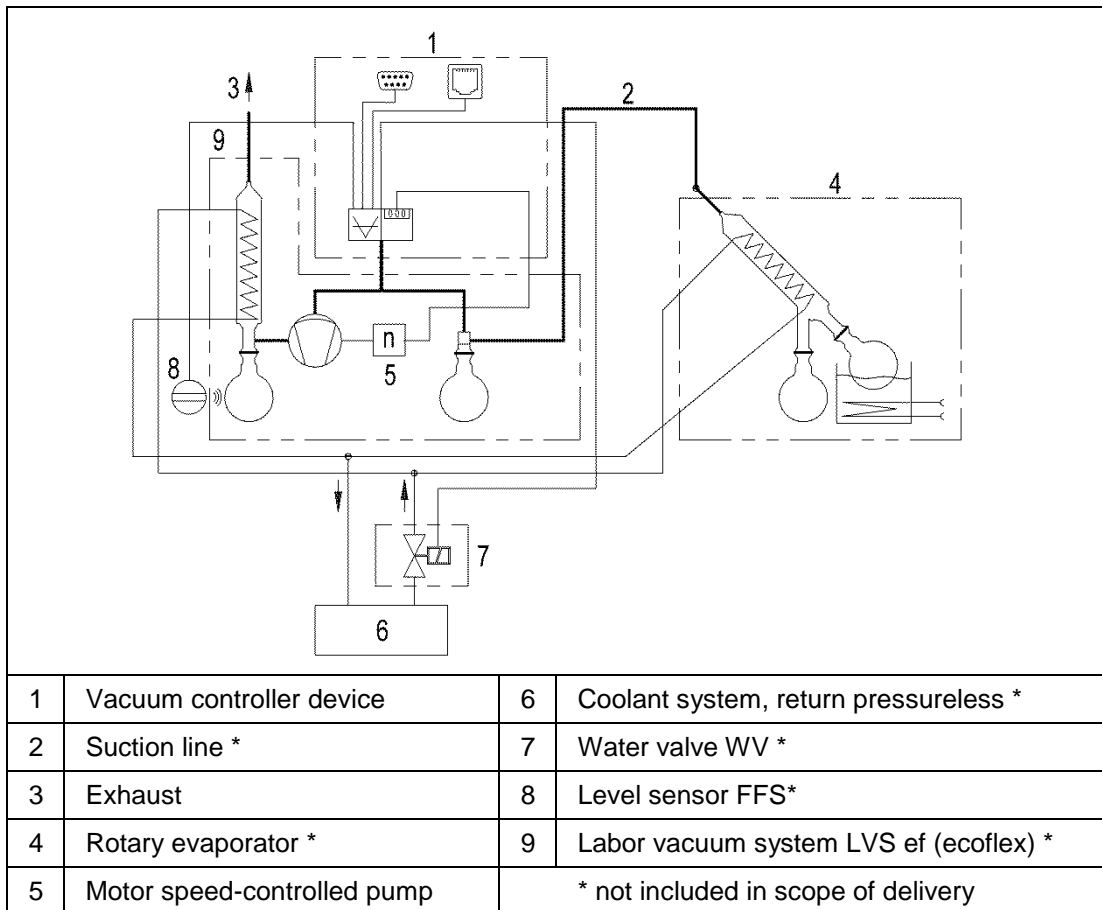

4.5 Explanation of the symbols

Rear wall of the vacuum controller VCpro 601, VCpro 602

Figure	Pos.	Symbol	Description
	1		Connection: vacuum apparatus
	2		Connection: inert gas (ventilation valve)
	3	f1/f2	OUT: control wire for motor speed control
	4		OUT: water valve
	5		OUT: level sensor

Description



4.6 Interfaces

The following functions are possible via interfaces:

- Installation of the firmware on the end user device via PC software **WELCH-Control 601**
- Installation and update as well as operation of the vacuum controller via PC software **WELCH-Control 601** via the interfaces **RJ 45 LAN** and **RS 232**
- Measurement/control connection for optional units **water valve** and **level sensor**

	INFORMATION
	▶ The WELCH vacuum controller is compatible with all WELCH laboratory vacuum systems and WELCH diaphragm pump types. It is not blocked by any device-specific BUS system.

4.7 Accessories (options)

Figure	Designation	Order no.
	Water valve WV 1 Connection: 2 x G 3/4" external thread Cable length: 1 m	700300
	Water valve WV 2 Connection: G 3/4" union DN 8 hose nozzle Cable length: 1 m	700300-02
	Level sensor FSS Cable length: 2 m	700380
www.gardnerdenver.com/welch "Service" menu → download area	Operating software "PC-Control 601" Firmware	-

	INFORMATION
	▶ The scope of delivery is determined by the delivery contract!

5 Assembly and installation

5.1 Unpacking

Unpack the device carefully.

Check for:

- Transport damage,
- Matching with the specifications of the delivery contract and
- Completeness of the delivery.

Inform us immediately if there are differences from the contractually agreed-upon scope of delivery or damage!

Heed the manufacturer's General Terms and Conditions.

	ATTENTION
	<p>▶ Keep the packaging to send the vacuum controller back to the manufacturer's factory or an authorized workshop for repair.</p>



5.2 Set-up and connection

Depending on the device models, the device must be installed according to the identification affixed to it, *see Chapter 4.4 Device models*:

- Heed the appropriate safety instructions.
- When setting up the vacuum controller, make sure that the distance to adjacent surfaces is at least 5 cm. At the same time, ensure that there is sufficient ventilation.
- Use only pre-assembled lines from the manufacturer, which prevents incorrect connections.
- Check the vacuum lines and vacuum connections of the entire system for any leakage before beginning work.

5.3 Electrical connection

The electrical connection is made with device connection cables with protective insulation.

 	⚠ DANGER
	<p>▶ Caution, there is danger to life due to electrical energy when opening the device.</p> <p>▶ If the user changes the electrical connection, e.g. for installation in a system, this may only be done by a trained electrician adhering to the accident prevention regulations.</p> <p>▶ Before opening the device, disconnect the power plug!</p>

	ATTENTION
	<p>▶ By opening the device, the printed circuit board and display can be destroyed by electrostatic discharge.</p>

Assembly and installation

5.4 Communication interfaces

For communication with the device via LAN (RJ45), a connection cable with at least CAT-6 must be connected. For the serial connection (RS232), a standardized cable can be used.



ATTENTION

- ▶ **Switch the device off before connecting or disconnecting the communication interfaces.**

5.5 Storage

The device must be stored indoors in a low-dust environment. The storage specification must be adhered, see *Chapter 3.1 Properties*.



ATTENTION

- ▶ **For storage, all connections must be sealed with the appropriate included protective caps.**
- ▶ **Another equivalent protective cap can also be used for storage.**

6 Operation

6.1 Start-up







	ATTENTION
▶ Read the safety instructions before start-up see <i>Chapter 2 Safety</i> .	

1. Connect the device according to the specification and the figures; see Chapter 3.3 *Pneumatic connections* and 4.4 *Device models*.
2. Use the device main switch **I/O** to switch on the vacuum controller. After a brief initialization routine, during which **STARTING** is show, the vacuum controller is ready for operation.

6.2 Operating modes and system settings

6.2.1 Operating mode 1 Manual

In the operating mode **Manual**, the setpoint of the pressure is readjusted by the system.

PARAMETER	VALUE	UNIT
Set Pressure	1000	mbar
Auto Stop Time	00:00:00	hh:mm:ss
Vent at Finish	Yes / No	
     		

Parameter	Values from/to	Resolution	Default	Unit
Set Pressure	0...1100	1	1000	mbar
Auto Stop Time	00:00:00...23:59:59	01:01:01	00:00:00	hh:mm:ss
Vent at Finish	Yes / No		No	

The pressure setpoint can be specified as a parameter or adjusted in real time during operation using the operating elements, see *Chapter 4.3.1 Operating elements and display*. Both the regulated pressure drop as well as the pressure increase are possible. The pressure increase requires, depending on the application, a ventilation of the system. The latter must be released in the vacuum controller's system settings, see *Chapter 6.2.6 System settings*.

Operation

6.2.2 Operating mode 2 Automatic

In the operating mode **Automatic** a material separation of a mixture up to maximum 4 components can be performed.

PARAMETER	VALUE	UNIT
Detection Gradient	0	mbar / min
Δp Distillation Ramp	0	mbar
Δt Distillation Ramp	00:00:00	hh:mm:ss
Number of Cycles	1	#

Parameter	Values from/to	Resolution	Default	Unit
Detection Gradient	-200...200	1	0	mbar/min
Δp Distillation Ramp	-1000...0	1	0	mbar
Δt Distillation Ramp	01:00:00...23:59:59	01:01:01	1:00:00	hh:mm:ss
Number of Cycles	1...4	1	1	
Vent at Finish	Yes / No		No	
Maximum RPM Speed	10...100	1	50	%

NOTE The parameter "RPM" can only be set for the VCpro 602 model.

The separation of the material mixture is done by searching for the boiling point of the respective component via the detection gradient. If the pressure gradient changes with a sudden increase or drop when a component begins to boil, then this pressure value will be assumed as start setpoint. The distillation of the components is then done by running the distillation ramp. The user must specify the detection gradient for the boiling and the distillation ramp for the component separation.

6.2.3 Operating mode 3 Program

In the operating mode **Program** any pressure profile between 1100...0 mbar can be programmed and up to 100 cycles run.

PARAMETER	VALUE	Unit
Adjust Pressure Table	1	Line(s)
Number of Cycles	1	#
Vent at Finish	No	

Parameter	Values from/to	Resolution	Default	Unit
Pressure Table	1...20	1	1	Line(s)
Number of Cycles	1...100	1	1	#
Vent at Finish	Yes / No		No	

A program includes a maximum of 20 setpoints. There is linear interpolation between the setpoints. The input of the setpoints p and the adjustment time Δt are specified in tabular form.

Δt [hh:mm:ss]	p [mbar]
00:00:00	0
Add new line	

Parameter	Values from/to	Resolution	Default	Unit
Δt	00:00:00...23:59:59	01:01:01	00:00:00	hh:mm:ss
p	1...1100	1	0	mbar

The set pressure setpoint p is reached in a defined timespan "setting time" Δt . In the process, depending on the previous actual value, the pressure is reduced to the setpoint, held or increased. There is linear interpolation between the pressure setpoints.

Operation

Add and delete line

Line	Activity
Add	<ul style="list-style-type: none"> ➤ Select Add new line by encoder ➤ PRESS the encoder and the new line will be added
Delete	<ul style="list-style-type: none"> ➤ Select the line (parameter time Δt or pressure p) to be deleted ➤ The encoder PRESS hold 2 sec and the line will be deleted

Graphic example for a series of pressure setpoints **p** and the associated setting times Δt

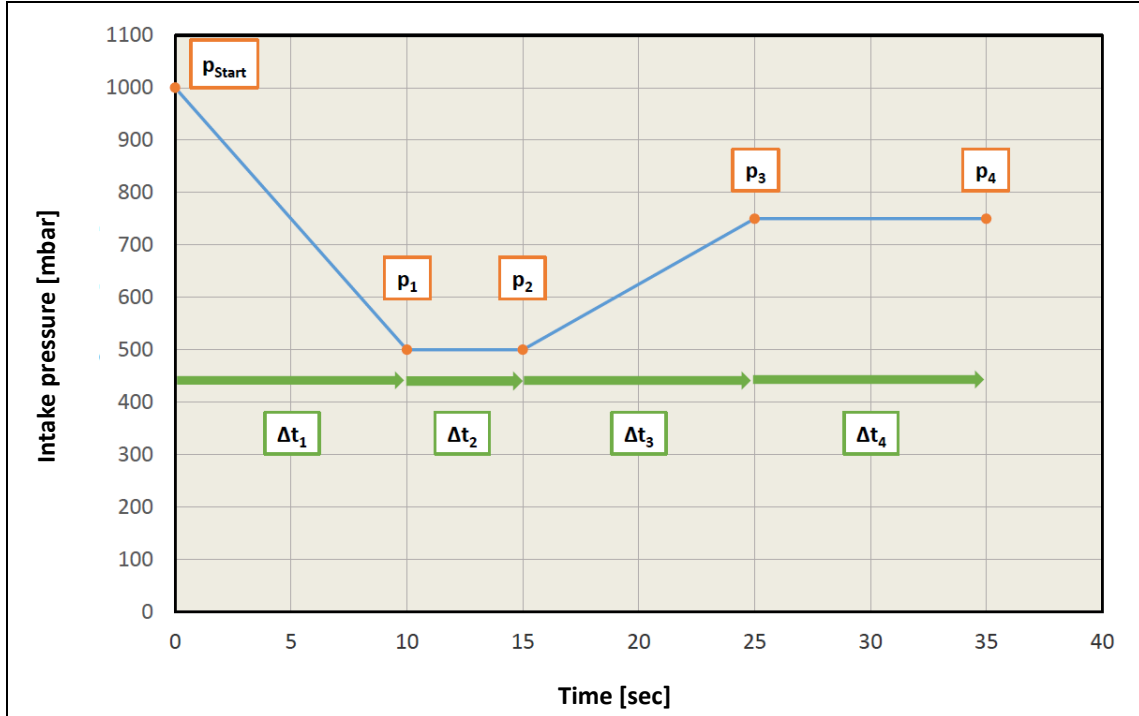

6.2.4 Operating mode 4 Multi-pump

NOTE The operating mode **Multi-pump** is currently not available on the VCpro 600 series.

6.2.5 Operating mode 5 Self-cleaning

The operating mode **Self-cleaning** handles the purging and drying of the pump and the pneumatic supply lines.

PARAMETER	VALUE	Unit
Cleaning Time	120	sec

Parameter	Values from/to	Resolution	Default	Unit
Cleaning Time	1...600	1	120	sec

The ventilation valve is opened and, due to the flow rate generated by the pump, the pump and the pneumatic supply lines are purged in the specified time. The respective device models are controlled as follows:

VCpro 601 model → vacuum control valve open

VCpro 602 model → maximum motor speed of the vacuum pump connected

ATTENTION	
	<ul style="list-style-type: none"> ▶ The application is ventilated with this procedure. ▶ If no other gas type is connected to the inert gas connection of the ventilation valve, the cleaning is done with air.

6.2.6 System settings

SYSTEM SETTINGS	
Language	
Display	
Control System	
Maintenance Timer	



Parameter	Values from/to	Resolution	Default	Unit
1 – Language				
	English German French Spanish Russian Chinese		English	

NOTE If you have inadvertently selected the wrong language and you therefore can no longer navigate, the following process will help:

1. Reset to factory setting
(= last option under system settings)
2. Do you really want to reset? = Yes (right) the language will be reset to English.

Operation

Parameter	Values from/to	Resolution	Default	Unit
2 – Display				
Brightness	0...100	1	70	%
Color scheme	Light Dark		Light	
Pressure unit	mbar kPa Torr Psi		mbar	
Pressure scale	Logarithmic Linear		Logarithmic	
NOTE Logarithmic and linear output of the pressure range for both numerical and graphic display.				
Pressure range				
Maximum pressure pMax	0...1000	1	1000	mbar
Minimum pressure pMin	0...1000	1	1	mbar
NOTE For a logarithmic pressure scale, pMin = 1 mbar is used automatically.				
Time range graph	0..1200	1	60	sec
NOTE Defines the time range for the graphic display.				
Graph display mode	Static Dynamic		Static	
Static: Pressure profile is updated from left to right on the display. Dynamic: Pressure profile runs in real time from right to left via the time axis.				
3 – Control system				
Calibration				
NOTE Requires a calibrated sensor for the calibration! The vacuum controller uses a linear calibration of the sensor. The support points for the calibration are the atmospheric pressure and the ultimate pressure "low pressure" of the system.				
Atmospheric pressure	500...1500	1	1000	mbar
<ul style="list-style-type: none"> ➤ Ventilation valve open. ➤ Vacuum control valve closed (VCpro 601) or pump is switched off (VCpro 602). ➤ The sensor is subjected directly to the ambient pressure. 				
Low pressure	1...200	1	1	mbar
<ul style="list-style-type: none"> ➤ Ventilation pressure closed. ➤ Vacuum control valve open (VCpro 601) or pump runs at 100% rotation (VCpro 602). ➤ The sensor is subjected directly to the ultimate pressure. 				
NOTE The system should be in equilibrium for input of the pressure → Pressure value must remain constant.				
Hysteresis	1...200	1	10	mbar
Hysteresis is a range of tolerance around the pressure setpoint.				
NOTE A hysteresis value that is too small can cause frequent switching of the vacuum control valve and reduce the service life of the vacuum control valves!				

Parameter	Values from/to	Resolution	Default	Unit
Auto start	No / Yes		No	
<p>In case of power failure, the last active operating mode is started again.</p> <p>NOTE An automatic start-up can cause undesired reactions. Heed the Safety in Chapter 2.5.6 System functions!</p>				
Cooling water	Always Only during operation Run-on after end: 0...60	1	Always	min
Allow ventilation	No / Yes		No	
<p>NOTE Heed the Safety in Chapter 2.5.6 System functions.</p> <p>Setting this option disables all other ventilation settings in the individual operating modes. Enabling ventilation can be protected with an ADMIN password if necessary.</p> <p>The devices have a connection for inert gas DN4.</p>				
Setting locking timer	0...60	1	0	min
<p>NOTE The function can only be activated if a USER password is set.</p> <p>The device is locked if not being operated. The device is unlocked by entering the USER password. If the device is locked, the selected operating mode remains active.</p> <p>NOTE The device can be deactivated in hazardous situations. Heed Chapter 2.5 Special hazards EMERGENCY SWICHT OFF!</p>				
4 – Maintenance timer				
Reset	No / Yes			
<p>The maintenance timer serves to assist the user with the maintenance program of the connected pump. When pump maintenance is due, the user is informed of this when re-starting the system/vacuum controller. The time monitoring can be set back to zero after maintenance is performed by the user or WELCH Service.</p>				
5 – Access control				
Setting USER password	0-9	1 1 1 1	not set	
Set ADMIN password	0-9	1 1 1 1	not set	
Reset passwords	No / Yes			
<p>NOTE See Chapter 6.3.1 Access control</p>				
6 – Log files				
Create log files	No / Yes			
Log frequency	1...600	1	10	sec
Display log files				
<p>NOTE See Chapter 6.3.2 Log files</p>				

Parameter	Values from/to	Resolution	Default	Unit
7 – Network				
DHCP	Dynamic Static		Dynamic	
IP address	0.0.0.0 - 255.255.255.255	1.1.1.1	0.0.0.0	
Subnet mask				
Gateway				
Status (info view)				
<p>The vacuum controller is network-capable. Using an Ethernet connection, the controller can be connected to the LAN and controlled using PC software. Firmware updates can also be performed via LAN.</p> <p>The network status is monitored in real time and can be used by the user at any time to verify access to the local network.</p> <p>NOTE See Chapter 6.4 "PC-Control 601" PC software (Option)</p>				
8 – Time and date				
Set time	00:00:00 - 23:59:59	01:01:01		hh:mm:ss
Set date	01.01.2018 - 31.12.2099	01.01.2001		DD.MM.YYYY
Time and date are reset with factory setting.				
9 – System information				
Hardware version				
Software version				
Total operating time				
Maintenance timer				
<p>NOTE The maintenance timer displays the operating time since the last resetting of the system and can be reset to zero, see Chapter 4 – Maintenance timer</p>				
10 – Reset to factory settings				
Reset	No / Yes			
<p>NOTE See Chapter 6.3.3 Reset to factory settings</p>				

6.3 Configuring the vacuum controller

6.3.1 Access control

The device offers the opportunity to grant access rights using two profiles.

- **USER password:** protects the vacuum controller's operating area. The password is also required on restart or to unlock the device.
- **ADMIN password:** additionally protects the device's system settings and can be used for unlocking.

If passwords are used on the end device, these passwords are also required for access via PC.

NOTE You must set the ADMIN password before you can set the USER password.

Set ADMIN password

1. Select the "System settings" menu option.
2. Select the "Access control" menu option.
3. Select the "Set ADMIN password" menu option.
4. Select 4 numbers between 0-9.
5. Confirm the 4 numbers by entering them again.
6. Confirm your selection with "OK."

Set USER password

1. Select the "System settings" menu option.
2. Select the "Access control" menu option.
3. Select the "Set USER password" menu option.
4. Select 4 numbers between 0-9.
5. Confirm the 4 numbers by entering them again.
6. Confirm your selection with "OK."

Reset passwords

1. Select the "System settings" menu option.
2. Select the "Access control" menu option.
3. Select the "Reset passwords" menu option.
4. Confirm your selection with "Yes."

6.3.2 Log files

Create log files

1. Select the "System settings" menu option.
2. Select the "Log files" menu option.
3. Select the "Create log files" menu option.
4. Confirm your selection with "Yes."

Log frequency

1. Select the "System settings" menu option.
2. Select the "Log files" menu option.
3. Select the "Log frequency" menu option.
4. Select a setting between 1 s and 600 s.
5. Confirm your entry.

Display log files

1. Select the "System settings" menu option.
2. Select the "Log files" menu option.
3. Select the "Log files" menu option.
4. Select a log file.
5. Confirm your entry.

Delete log files

1. Select the "System settings" menu option.
2. Select the "Log files" menu option.
3. Select the "Display log files" menu option.
4. Press the rotary encoder for 2 s.
5. You will see "Do you really want to delete log files?"
6. Confirm your selection with "Yes."

6.3.3 Reset to factory settings

1. Select the "System settings" menu option.
2. Select the "Reset to factory settings" menu option.
3. Confirm your selection with "Yes."

NOTE After selecting "Yes" (with check mark), the language is set back to the factory setting (English). All values are also reset to the factory settings.

6.4 "PC-Control 601" PC software (Option)

The **PC-Control 601** handles remote control of the vacuum controller VCpro 600 series. Generally, the PC software offers all control possibilities, just like on the end device. In addition, the following operations are possible with the PC software:

- Firmware updates
- Transfer time and date from the PC
- Factory settings & factory calibration (not public)

6.4.1 Installation

NOTE The PC software can be downloaded as installer package. The file "setup.exe" installs the PC software and the required CVI Runtime Environment.

1. Select the **"PC-Control 601"** PC software. It is available as freeware from www.gardnerdenver.com/welch on the "Service" menu → download area.
2. Call up the PC software with "VC601_XXX.exe" in the installation directory.
NOTE XXX describes the sequential version number of the PC software.

6.4.2 Connection settings

The vacuum controller can be addressed via RS232 or LAN. Using the menu bar (see Chapter 6.4.3 Main screen) it is possible to establish the connection under [Communication Settings!].

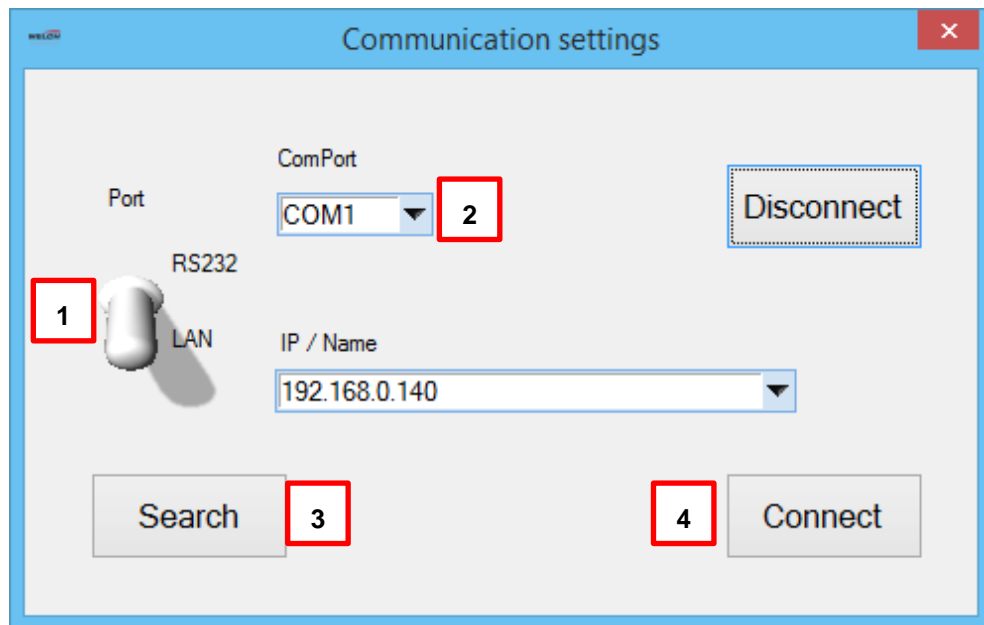

1. Use the toggle switch **Port** (1) to toggle between **RS232** and **LAN**.
2. Select the port used. For **ComPort** (2), all ComPorts found on the PC are listed.
3. Search the LAN network for vacuum controllers in **LAN** mode using the **Search** button (3). The list of vacuum controllers on the network is updated; with the list you can select a vacuum controller device. The vacuum controller will be recognized on a pre-defined UDP port via broadcast key.
4. The connection is established with **Connect** (2). Here it must be noted that only one connection per vacuum controller is permitted.

NOTE	
	<ul style="list-style-type: none"> ▶ If the device is locked, either the user password or the admin password is requested in order to unlock the end device and communicate via PC software. ▶ The exception is the first press of the STOP button, which can be pressed without a password, also on the end device, for safety reasons in order to switch off the function of the end device.

Operation

6.4.3 Main screen

When starting the PC software and by pressing the **Measure** (A) button, you open the main screen.

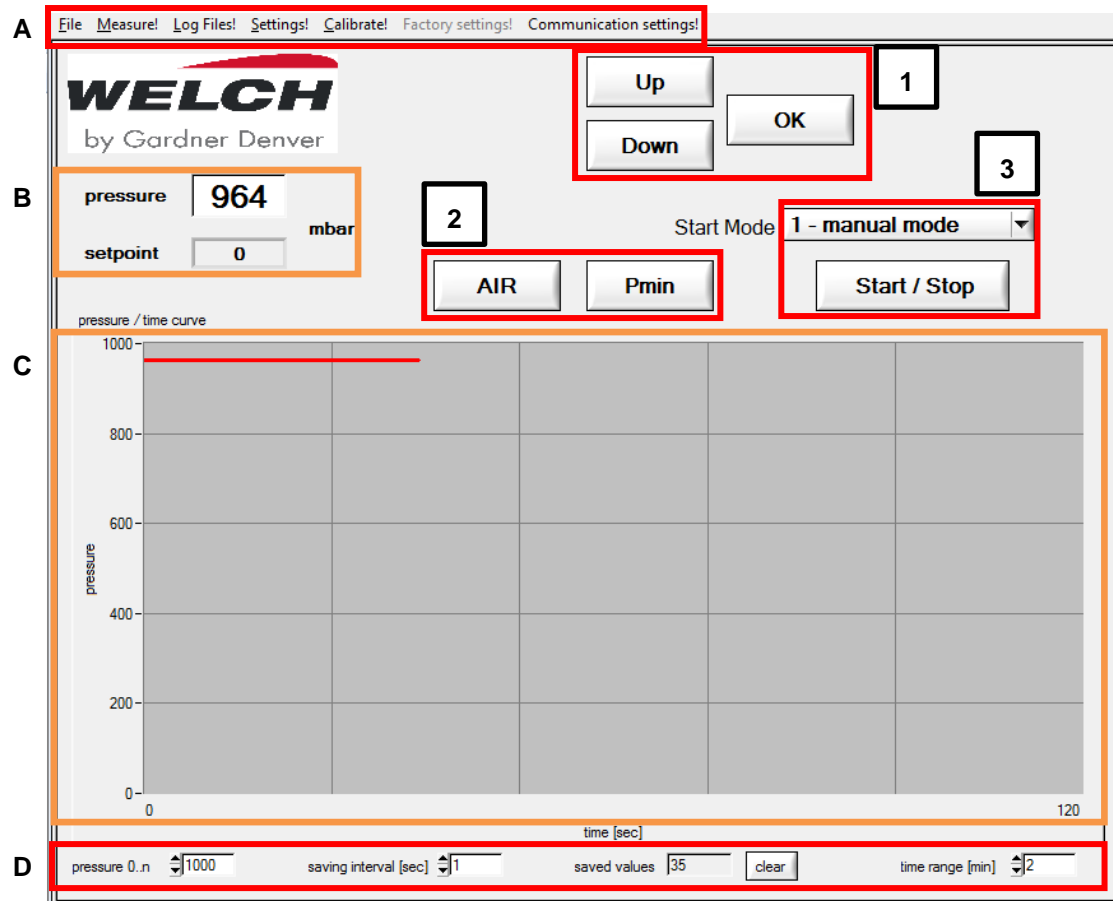

The graphic shows the course of the pressure over time (C). Here, both the time and the pressure display area can be set using the parameter field (D). The keys correspond largely to the keys on the vacuum controller. The buttons are operated with the left mouse button.

Pos.	Element	Function
A	<Menu bar>	Selection of the function areas of the PC software
B	<Display field>	Numeric specification: <ul style="list-style-type: none"> ➤ Pressure actual value pressure ➤ Pressure setpoint
C	<Display field>	Display of pressure actual value (red line) over time for the connected device
D	<Parameter field>	Setting of the diagram axes: <ul style="list-style-type: none"> ➤ pressure 0..n (10...1600 mbar) ➤ time range [min] (1...83 min) and pressure data recording: <ul style="list-style-type: none"> ➤ Storage interval saving interval [sec] (1...60) ➤ Measurement points saved values (info display)

Pos.	Element	Function
1	<OK>	Sets current pressure as setpoint, only possible with active operating mode
	<Down>	Decrease setpoint with active operating mode > by 1 mbar when pressed once > continuously when pressed and held
	<Up>	Increases temporary setpoint for active operating mode > by 1 mbar when pressed once > continuously when pressed and held
2	<Pmin>	Starts maximum pressure reduction
	<Air>	Opens the ventilation valve when pressed or closes it when released
3	<Start Mode>	Selection of the operating mode that should be started
	<Start / Stop>	Starts or stops the active operating mode

6.4.4 File

File	
Save settings	Save settings of the Settings dialog in a file
Load settings	Load settings of the Settings dialog from a file
Save memory	Save the pressure data in a file
Load memory	Load the pressure data from a file
Print curve	Print the current pressure curve on the default printer
Password	The password protects the factory settings of the vacuum controller. WELCH service can use the password to change the vacuum controller's factory settings.
Info	Information about the software version
Firmware update	Install the selected firmware file on the end device
Exit <ESC>	Exit PC software

Operation

6.4.5 Log files

On the **Log Files** menu, you can display and delete the data saved on the vacuum controller and on the PC.

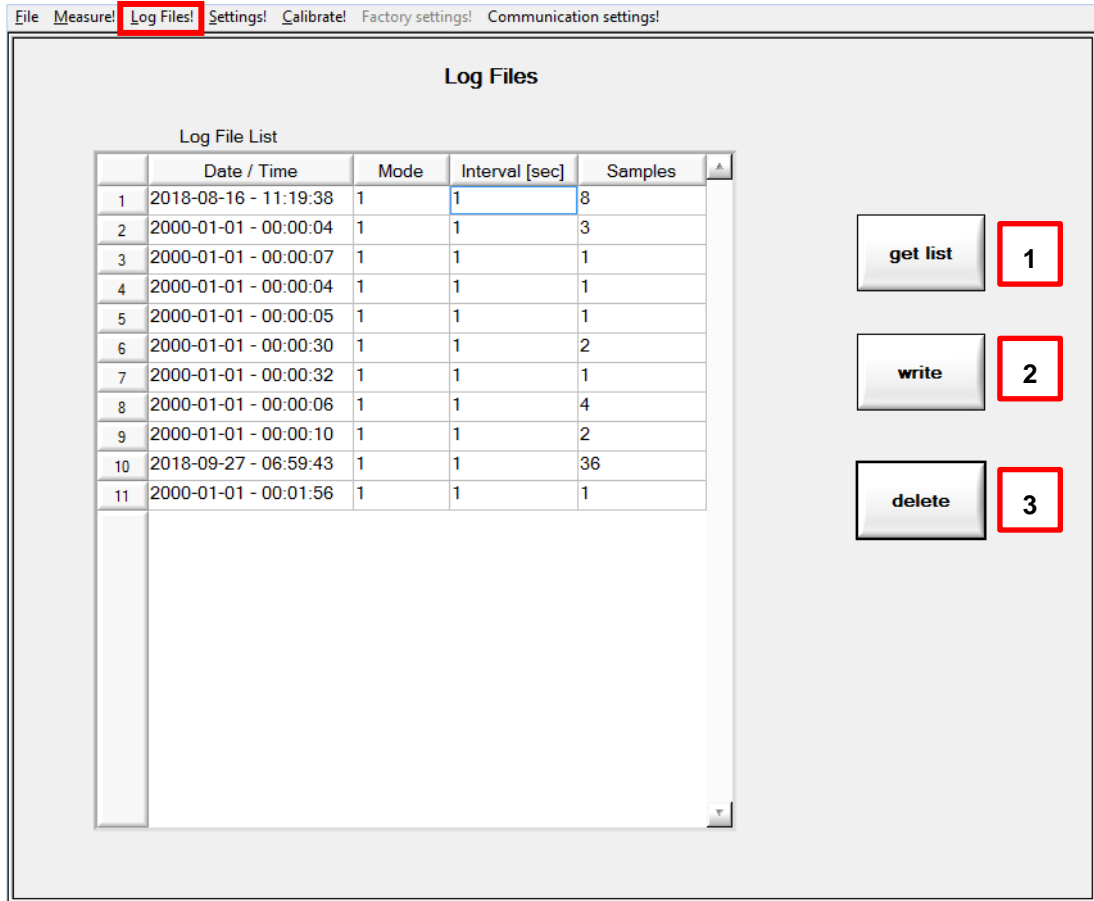

Display the log files with **get list** (1). Use **write** (2) to save the log file. Use **delete** (3) to delete the log files.

```
VC601 log file from 2018-11-21 - 08:35:24
Mode 1
Intervall: 1 sec
Samples: 45
Pressure [mbar] setpoint [mbar] speed [%]          IO-State
936.4    1000.0    0           0x0B
936.1    1000.0    0           0x0F
937.0    1021.0    0           0x0F
937.9    994.0     0           0x0F
937.3    941.0     0           0x0B
934.6    872.0     76          0x0B
929.2    808.0     100         0x0B
931.3    738.0     100         0x0B
930.7    0.0       100         0x0B
```

The ASCII file is saved as *.vcl and can be opened with a text editor (as pictured above). The first three columns display the actual value **Pressure [mbar]**, **Setpoint [mbar]** and the motor speed **Speed [%]**. The current state **IO-State** of the actuators and sensors is output in hexadecimal format.

The hexadecimal formulation (the last two characters of the **IO-State** output) can be transformed into a 6-digit binary sequence, see *example below*. The status of the actuator or sensor in question is arranged from right to left in the 6-digit binary sequence.

Bit status: actuator / sensor

- 1 = active / open
- 0 = inactive / closed.

The following bit assignment is used for the logging:

Binary Pos.	Actuator / sensor
1	Relay output
2	Vacuum control valve output
3	Ventilation valve output
4	Cooling water valve output
5	Adjust level sensor
6	Level sensor input

Example: **0X0B** = 001011 → 0XHex = binary

Binary	Actuator / sensor
1	Relay output
1	Vacuum control valve output
0	Ventilation valve output
1	Cooling water valve output
0	Adjust level sensor
0	Level sensor input

Thus, the vacuum control valve and water valve are open and the ventilation valve is closed.

6.4.6 Settings

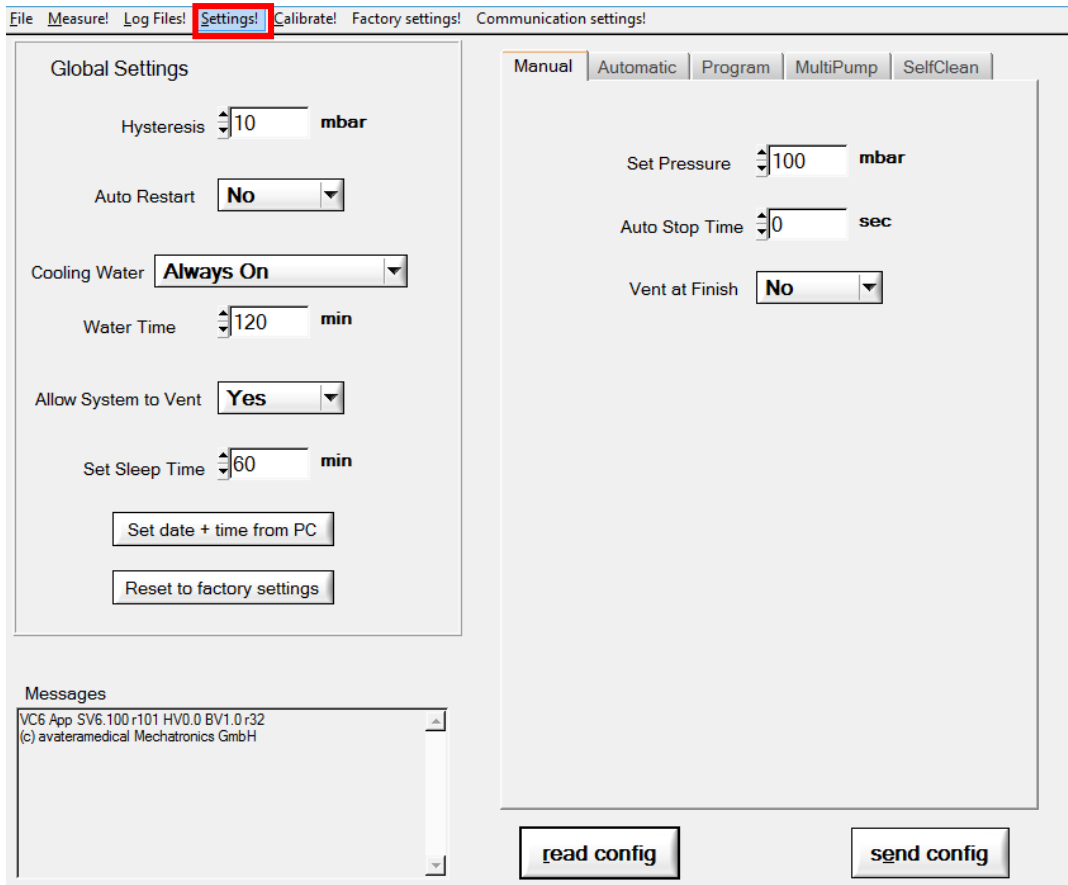

Left side of the screen:	Right side of the screen:
System settings for the control system	Settings of the values for the individual operating modes via the tabs: <ul style="list-style-type: none"> - Manual - Automatic - Program - MultiPump - SelfClean

For detailed information, see *Chapter 6.2 Operating modes and system settings*.

6.4.7 Calibrate

The calibration can be done here just like on the end device. A two-point calibration with comparison measurement device can be performed.

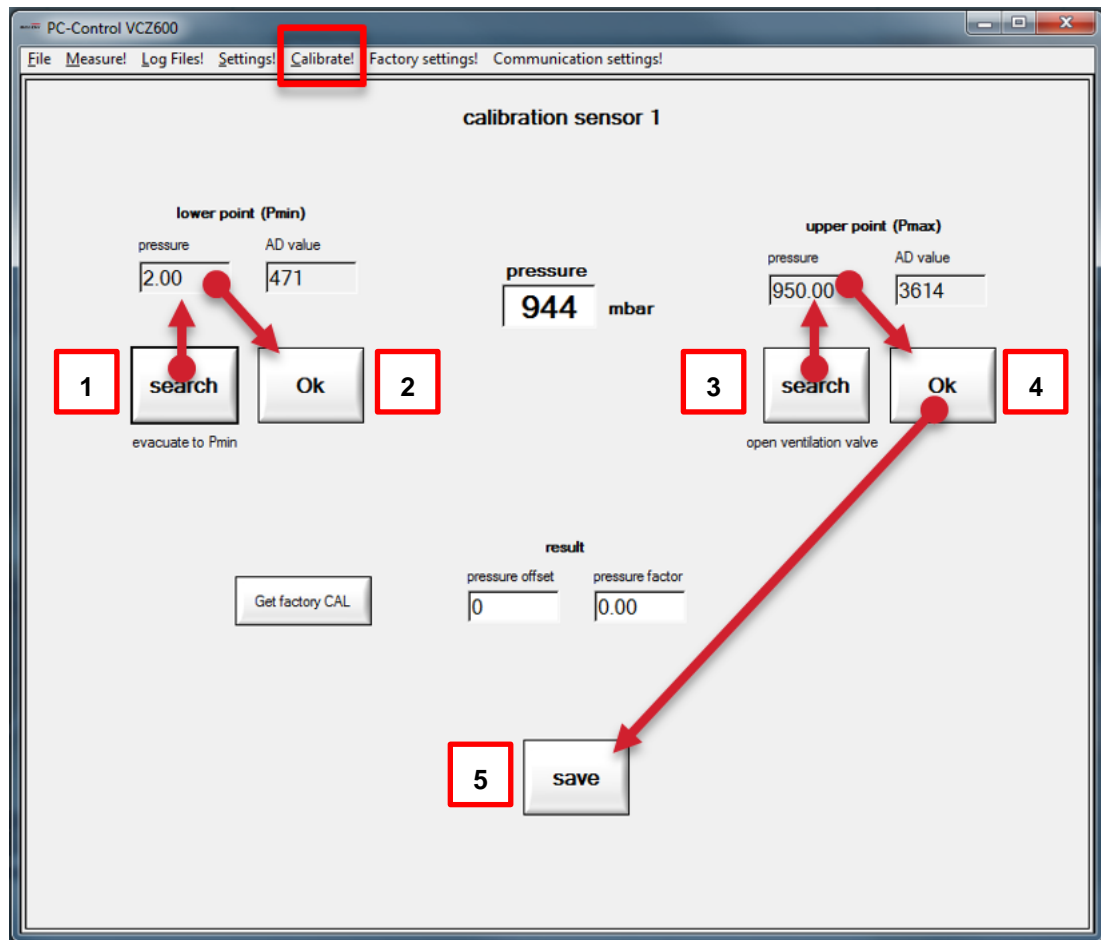

Procedure

1. Evacuation of the system with **search** lower point (Pmin) for the lower point.
2. Take over the value with **OK**, if the pressure is constant.
3. Ventilate the system with **search upper point (Pmax)** for the upper point.
4. Take over the value with **OK**, if the pressure is constant.
5. Takeover the settings with **save**. The calculated calibration coefficients are displayed.

Calibration with atmospheric pressure:	Calibration with low pressure (ultimate pressure):
The diaphragm pump is switched off	The diaphragm pump is switched on
The ventilation valve is open	The ventilation valve is closing
The vacuum control valve is closed	The vacuum control valve is opening
Sensor exposed to the ambient pressure	Sensor exposed to the ultimate pressure

With **Get factory CAL** the factory calibration can be loaded. The user cannot change the factory calibration.

CALIBRATION	
	<ul style="list-style-type: none">▶ Within the vacuum controller, 2 apirs of calibration coefficients (private and public) are saved.▶ The private variables correspond to the factory settings and can only be set by WELCH Quality or WELCH Service.▶ The public variables can be set by the user and overrate the factory calibration. With the "Reset factory settings" function (see <i>Chapter 6.3.3 Reset to factory settings</i>) the factory calibration is reset.

6.4.8 Firmware update

You will find the **Firmware update** function under the menu element **File**. The current version of the firmware is available from www.gardnerdenver.com/welch on the "Service" menu → in the download area.

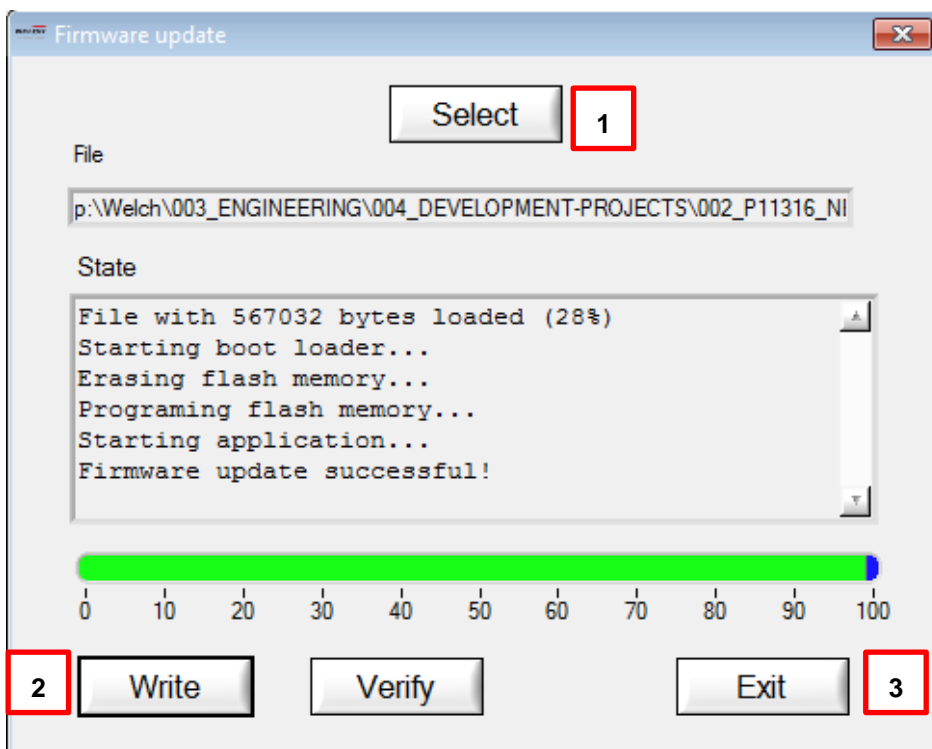

1. Select the firmware file *.hex with **Select**.
2. Perform the update with **Write**. After successful upload, you will see the message "**Firmware update successful.**"
3. Exit the menu with **Exit**.

6.5 Solvents table



OPERATION MODE

► The selection of the parameter pressure via the solvent table is only possibly in the operation modes Manual and Program.

1. On the navigation bar, select the operation mode by encoder.
2. Select the parameter **Set Pressure** at the current operating mode.
3. Press the **PMIN** button on the button bar. The table for selection of the pressure parameters appears:

Name	CAS No.	Vapor pressure p [mbar] at 40 °C
1,1,2,2,-TeCA	630-20-6	35
1,2,-dichlorethane	107-06-2	210
1,2,-dichlorethylene (c)	156-59-2	479
1,2,-dichlorethylene (t)	156-60-5	751
2-methyl-2-propanol	75-65-0	130
3-methyl-1-butanol	123-51-3	14
Acetone	67-64-1	556
Benzene	71-43-2	236
Chlorobenzene	108-90-7	36
Chloroform	67-66-3	474
Cyclohexane	110-82-7	235
Diisopropyl ether	108-20-3	375
Dioxan	123-91-1	107
DMF	68-12-2	11
Ethanol	64-17-5	175
Ethyl acetate	141-78-6	240
Ethyl methyl ketone	78-93-3	243
Heptane	142-82-5	120
Hexane	110-54-3	335
Isopropyl alcohol	67-63-0	137
Methanol	67-56-1	337
Methyl chloroform	71-55-6	300
n-butanol	71-36-3	25
n-pentanol	71-41-0	11
n-propyl alcohol	71-23-8	67
Pentachlorethane	76-01-7	13
p-Xylol	106-42-3	25
Tetrachlorethylene	127-18-4	53
Tetrachlormethane	56-23-5	271
Tetrahydrofuran	109-99-9	402
Toluene	108-88-3	77
Trichlorethylene	79-01-6	183
Water	7732-18-5	72

7 Maintenance

7.1 Service

	TECHNICAL SERVICE
	<ul style="list-style-type: none">▶ The device must be regular serviced and inspected in case substances are used that reduce the lifetime of wetted materials. <i>See Chapter 3.4 Parts in contact with internal gas.</i>▶ The operator is responsible for a service and inspection schedule to ensure safe operation.

Cleaning

Depending on contamination, components in contact with media (connections, valves, sensors) must be cleaned at regular intervals with a suitable solvent (e.g. acetone).

7.2 Repair



	ATTENTION
	<ul style="list-style-type: none">▶ Repair is only done if there is a completely filled-out damage report.▶ The specification of the contamination or the complete cleaning is a legal component of the contract.

Transfer a defective device to the manufacturer or an authorized workshop for repair. Depending on the applications, the user must create a new service and maintenance plan.

Damage report

The damage report form is available for download from our website www.gardnerdenver.com/welch on the "Service" menu → "Damage reports."

If you do not have access to the Internet, you can request the form from us
Tel.: +49 3677 604 0.

	WARNING
	<ul style="list-style-type: none">▶ Incompletely or incorrectly filled-out damage reports can endanger the service personnel!  <ul style="list-style-type: none">▶ Make complete statements in the damage report, especially with regard to a possible contamination of the components in contact with media.

7.3 Disposal

	ATTENTION
	<ul style="list-style-type: none">▶ Incorrect disposal can cause environmental damage.▶ Disposal must be done according to the legal regulations – according to directive 2012/19/EU.▶ Contaminated devices must be decontaminated according to the legal regulations.

8 Elimination of operating faults

Troubleshooting notes

Type of error	Cause	Remedy	
		by:	with:
Device does not start, no display	There is no power	User	check correct connection of the power cable (external), fuse
		Electrician	Check plug connector, electrical installation (e.g. power pack)
Vacuum control valve (VCpro 601) remains open	Evaporation rate too high	User or service workshop	Reduce evaporation rate
	Suction capacity of the vacuum pump too low		Use vacuum pump with higher suction capacity
	Pressure setpoint for the vacuum pump is too low		Increase the pressure setpoint or, if necessary, use a pump that delivers an ultimate pressure lower than the pressure setpoint
	Leak in the vacuum system		Search for and seal leak
The data display is OK – despite fault in the connected valves and the pump	Pump and/or valves defective (mechanically / electrically)	User or service workshop	Repair or exchange of the valves or pump
Vacuum controller cannot be set or programmed	Electronics / display defective		Repair or replace
Incorrect language	System setting set incorrectly	User	Set language: 1. Option under system setting, see <i>Chapter 6.2.6 System settings</i>
			Reset device: See <i>Chapter 6.2.6 System settings 10 – Reset to factory settings</i>
Access locked	ADMIN or USER password set	User / ADMIN or USER	See <i>Chapter 6.2.6 System settings</i> and <i>6.3.1 Access control</i>
No access to vacuum controller via PC	No connection established to the PC	User	Check cable connection of the data connection and check connection status under System setting → Network → Status "connected"
	IP addressing not correct	User	Check IP address if necessary set DHCP to "dynamic", see <i>Chapter 6.2.6 System settings 7 – Network</i>

Elimination of operating faults

Type of error	Cause	Remedy	
		by:	with:
Incorrect pressure value specification	Calibration incorrect	User	Recalibrate pressure sensor: <i>see Chapter 6.2.6 System settings 3 – Control system / Calibration</i>
			Reset device: <i>See Chapter 6.2.6 System settings 10 – Reset to factory settings</i>
Cable	defective or brittle	Electrician	Replace the cable(s)

	REPAIR
	▶ Repairs may only be made by authorized workshops or by the manufacturer!

9 Spare parts overview

The spare parts list includes all spare parts with the required order information.
When placing your order, specify the name, quantity, serial number and order number!

	LIABILITY
	<p>► We are not liable for damage due to the installation of other parts than those provided by the manufacturer, Gardner Denver Thomas GmbH.</p>

9.1 Spare parts list device

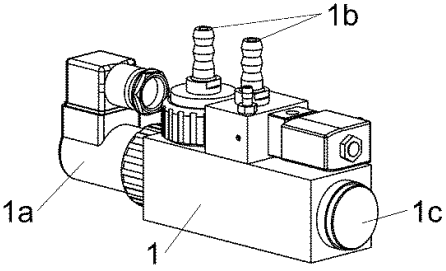
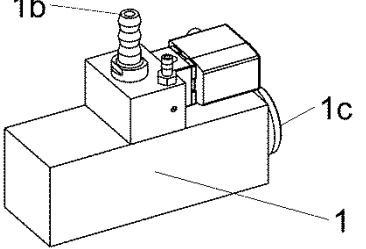
No.	Designation	Quantity	Order numbers	
			600100 VCpro 601	600101 VCpro 602
1	Subassembly VCpro 601 complete	1	620608	
				
1	Subassembly VCpro 602 complete	1	-	620609
				
1a	Vacuum control valve	1	827513-2	-
1b	Hose nozzle PP, DN8-G1/4"	2	710798	
1c	Blind cover	1	620609-01	
	O-ring EPDM, Ø22x2 for blind cover	1	829239-3	
2	Enclosure foot	5	829110	
3	Device connection cable IEC with:	1		
	- CEE (D) plug		825885	
	- BS (UK) plug		825878	
	- NEMA5-15 (US) plug		825903	

9.2 Ordering and service contact

Manufacturer:

Gardner Denver Thomas GmbH
Am Vogelherd 20
98693 Ilmenau
Germany

T +49 3677 604 0

F +49 3677 604 131

welch.emea@gardnerdenver.com

www.gardnerdenver.com/welch

Customer support +49 3677 604 0

10 Appendix

10.1 EU declaration of conformity

EU declaration of conformity
Translation of the original declaration (EN)



Gardner Denver Thomas GmbH
Am Vogelherd 20
98693 Ilmenau
Germany

We hereby declare under our own responsibility that the following product, based on its design and construction and on the documents we have put into circulation corresponds to the EC directives and standards listed below. In case of a change to the product not agreed upon with us, this declaration is no longer valid.

Description of product	
Type	Vacuum controller
Designation	VCpro 601, VCpro602
Item no.	600100, 600101

The product corresponds to the following directives and standards:	
2006/42/EC	Machinery Directive
2014/30/EU	Directive relating to electromagnetic compatibility (EMC)
2011/65/EU	Directive on the restriction of the use of certain hazardous substances in electrical and electronic equipment (RoHS)

Applicable harmonized standards::	
ISO 12100:2010	Safety of machines - General principles for design - risk assessment and risk reduction
IEC 61010-1:2010	Safety requirements for electrical measurement, control and laboratory use - Part 1: General requirements
IEC 61326-1:2012	Electrical measurement, control and laboratory use - EMC requirements - Part 1: General requirements
IEC 63000:2018	Technical documentation for assessment of electrical and electronic devices with regard to the limitation of hazardous materials

Authorized representative headquartered in the European Community and person who is authorized to create the technical documents.

Place, date: Ilmenau, 11.07.2019

Robert Götz
Plant Manager

Gardner Denver Thomas GmbH
Am Vogelherd 20
98693 Ilmenau / Germany
T +49 3677 604 0
F +49 3677 604 131

welch.emea@gardnerdenver.com
www.gardnerdenver.com/welch

10.2 Notes

Gardner Denver Thomas GmbH
Am Vogelherd 20
98693 Ilmenau
Germany